

QST

June, 1938
25 cents

devoted entirely to

amateur radio

In this issue—
**A New Type
Directive
Antenna—
Building a
Modern
One-tube
Receiver**

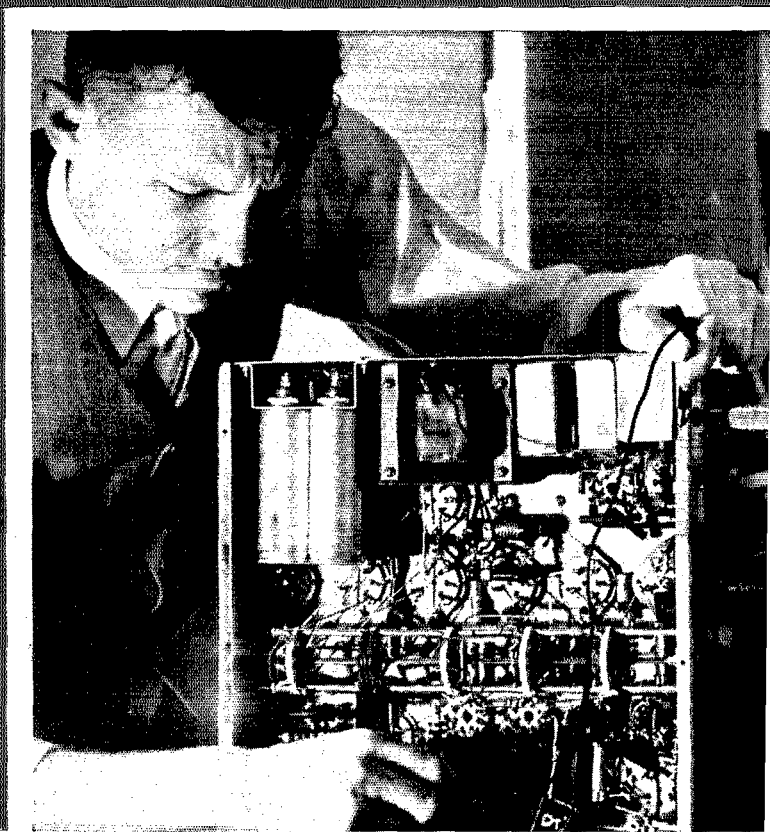

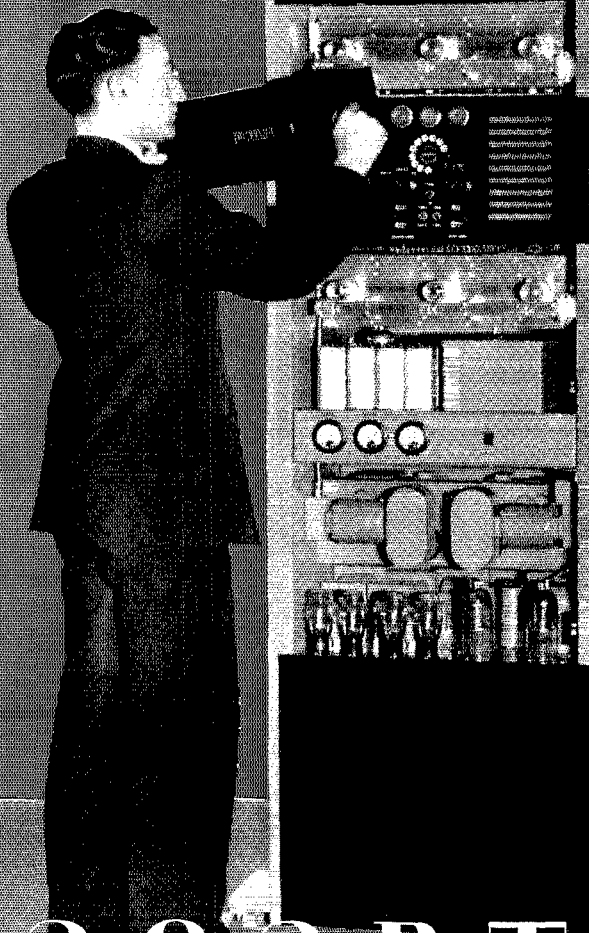

202BTA

This 202BTA Autotune Transmitter is being installed by a prominent yachtsman to afford constant ship to shore telephone communication. Nineteen frequencies are automatically selected and the transmitter is fully controlled from any of the telephone extensions aboard.

COLLINS RADIO COMPANY

CEDAR RAPIDS, IOWA
 NEW YORK, N. Y. 11 WEST 41 ST.

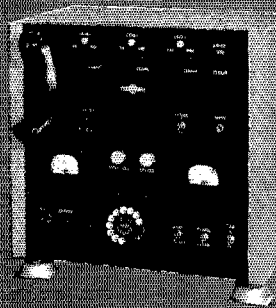

CONTROL UNIT SPEECH
 AMPLIFIER AND TONE
 FREQUENCY EXTENSION
 SWITCHING PANEL USED
 WITH THIS 202BTA

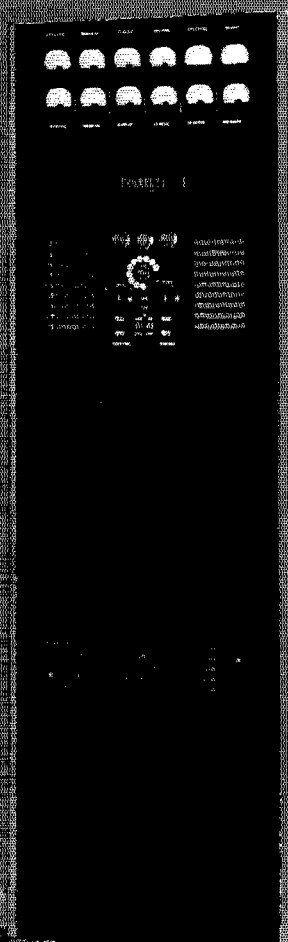

The SKYRIDER DIVERSITY, A Dual Diversity Receiving System

ONLY RAYTHEON TUBES

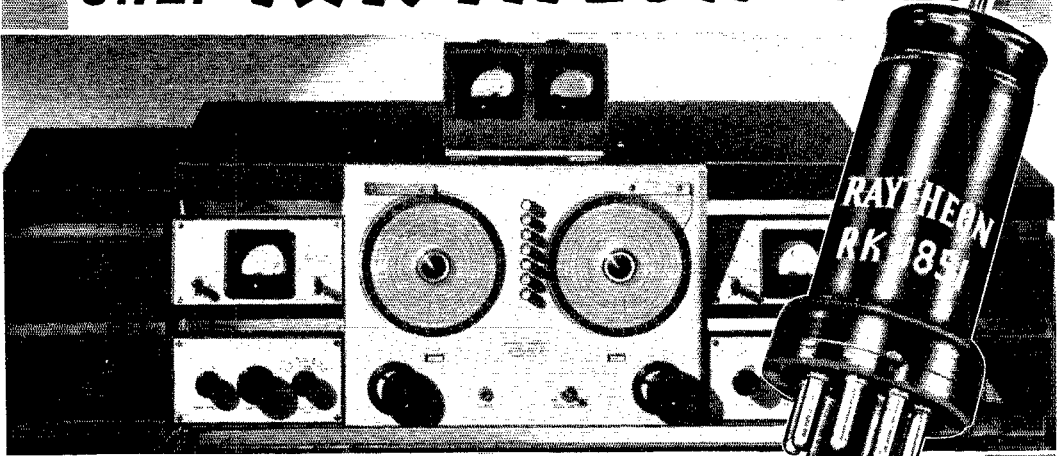

ARE USED IN THE sky rider diversity

FOR the first and finest amateur Dual Diversity Receiver, where expense was no object, Hallicrafters selected these finer radio tubes—RAYTHEON! New to any receiver — Hallicrafters incorporated the new RK 1851 — the newest development in tubes. The RK 1851 opens new fields in the ultra-high frequency bands, and permits high frequency gains several times those of any conventional tubes.

Raytheon salutes the Hallicrafters' engineers, the pioneers of a new and better receiver which incorporates all the latest advances in radio!

AND FOR YOUR RIG . . . USE *Quality* RK Triodes!

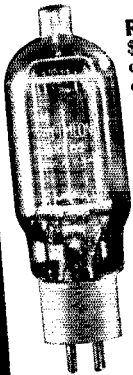

RK51—170 watts output at 70% efficiency . . . with 10 watts drive — for only \$8.00. This means less than five cents per watt! A top quality tube built by an organization that *knows* tubes, and has pioneered many outstanding tube developments.

Big, heavy filaments (28.1 watts)! Hard glass envelope makes it absolutely gas-free. Oversized heavy carbon plates. Lava insulators. No mica. A big four-post stem to insure maximum strength.

RK52—250 watts output (2 tubes). Only 7.5 watts drive. A true zero bias Class B tube designed so that at full output there is less than 5% distortion. Double grid structure assures low idling current — eliminates need for bias — and keeps distortion down. Also makes an excellent R. F. amplifier. Amateur net price \$8.00.

RAYTHEON
RK
AMATEUR TUBES

CHICAGO
ATLANTA
NEWTON, MASS.
NEW YORK
SAN FRANCISCO

the hallicrafters inc.

Say You Saw It in QST' — It Identifies You and Helps QST'

The SKYRIDER DIVERSITY, A Dual Diversity Receiving System

P. R. MALLORY & CO. Inc.
MALLORY

THE NEW
**MALLORY
YAXLEY**
TYPE M. C. PUSH BUTTON
BAND SWITCH

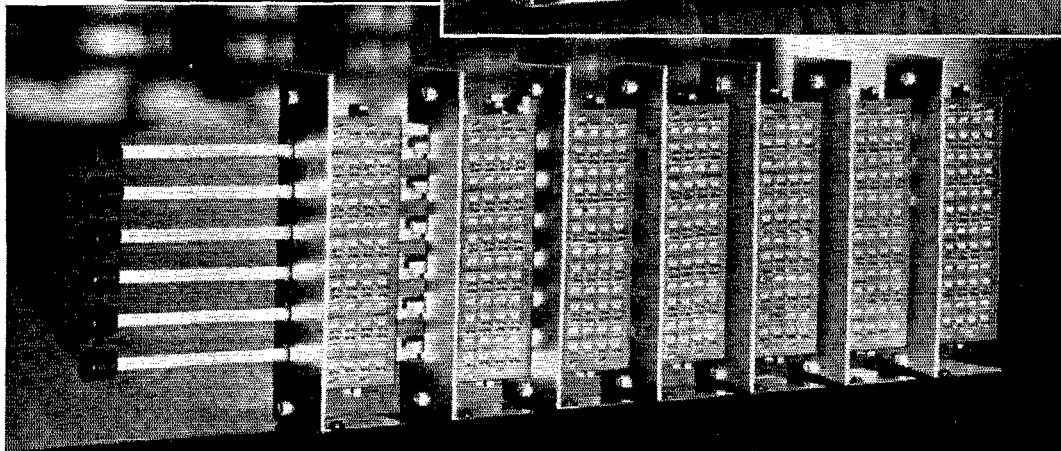
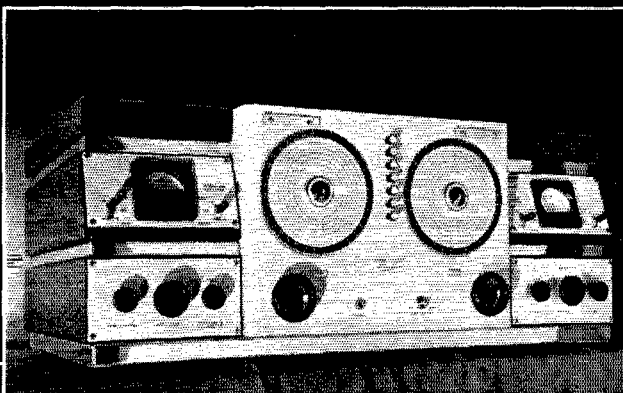

Especially Adapted to the New sky rider diversity

The Hallicrafters' SKYRIDER DIVERSITY begins an entirely new era in amateur receiver design. We are proud to have a share in the construction of this revolutionary new receiving system. The new Mallory-Yaxley Type MC Push Button Band Switch was especially adapted to and is being used for the first time on this, the greatest achievement of the Hallicrafters' laboratory.

This switch, with its 336 contacts, is in itself an outstanding achievement in design, a perfect example of the craftsmanship that is characteristic of all Mallory-Yaxley products! Ask your parts distributor for Mallory-Yaxley products when you want the utmost in dependability and precision!

MALLORY-YAXLEY Amateur Radio Products

- Radio Switches
- Fixed and Variable Resistors
- Attenuators
- Condensers (all types)
- Vibrator Power Supplies
- Vibrators and Rectifiers
- Grid Bias Cells
- Jacks, Plugs, Panel Lights, Outlets, Cable Connectors and Accessories

P. R. MALLORY & CO., Inc.
INDIANAPOLIS INDIANA

Cable Address — PELMELLO

YAXLEY

the hallicrafters inc.

QST

devoted entirely to

AMATEUR RADIO

PUBLISHED, MONTHLY, AS ITS OFFICIAL ORGAN, BY THE AMERICAN RADIO RELAY LEAGUE, INC., AT WEST HARTFORD, CONN., U. S. A.; OFFICIAL ORGAN OF THE INTERNATIONAL AMATEUR RADIO UNION

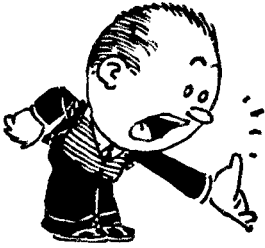

JUNE
1938

Volume XXII
Number 6



Kenneth B. Warner, General Manager of A.R.R.L. Publications; Ross A. Hull, Editor; James J. Lamb, Technical Editor; George Grammer, Assistant Technical Editor; Clark C. Rodimon, Managing Editor; David H. Houghton, Circulation Manager; Ralph T. Beaudin, Assistant Circulation Manager; F. Cheyney Beekley, Advertising Manager; Charles Brunelle, Assistant Advertising Manager.

Editorial and Advertising Offices

38 La Salle Road
West Hartford, Connecticut

Subscription rate in United States and Possessions and Canada, \$2.50 per year, postpaid; all other countries, \$3.00 per year, postpaid. Single copies, 25 cents. Foreign remittances should be by international postal or express money order or bank draft negotiable in the U. S. and for an equivalent amount in U. S. funds.

Entered as second-class matter May 29, 1919, at the post office at Hartford, Connecticut, under the Act of March 3, 1879. Acceptance for mailing at special rate of postage provided for in section 1103, Act of October 3, 1917, authorized September 9, 1922. Additional entry at Concord, N. H., authorized February 21, 1929, under the Act of February 28, 1925.

Additional second-class entries to cover sectional editions authorized March 20, 1935. Copyright 1938 by the American Radio Relay League, Inc. Title registered at United States Patent Office.

The Contents

Editorial	7
Gang Tuning for the Multi-Stage Transmitter <i>Don H. Mix, W1TS</i>	8
The Extended Double Zepp Antenna <i>Hugo Romander, W2NB</i>	12
A C.W. and 'Phone Station Freqmeter-Monitor and Modulometer with Cathode Ray Tube <i>S. Leibowitz, W8BXN</i>	17
Atlantic Division Convention	19
What the League Is Doing	20
Glacier Park District Convention.	20
A New Type of Frequency-Checking Device <i>George Grammer, W1DF</i>	21
Hamdom <i>OE3AH</i>	25
75-Meter 'Phone Goes Hunting in the Maine Woods <i>P. L. Spencer, W1GBE</i>	27
W9RSO Wins 1937 H.P.M. Award	29
The Pentagrid Tube as a Combined Second Detector and Beat-Frequency Oscillator . . . <i>G. C. F. Whitaker</i>	30
Army-Amateur Radio System Activities	32
Sixth A.R.R.L. Field Day Contest	33
A Simple One-Tube Receiver . . . <i>T. M. Ferrill, Jr.</i>	34
The Fourth A.R.R.L. Copying Bee	37
How Would You Do It?	38
I.A.R.U. News	40
Hints and Kinks	42
Operating News	45
Correspondence Department	53
Standard Frequency Transmissions	70
WWV Schedules	70
Silent Keys.	92
Circulation Statement	92
A.R.R.L. QSL Bureau	94
New Products.	96
Book Reviews.	96
Hamads.	107
QST's Index of Advertisers.	110

Section Communications Managers of the A.R.R.L. Communications Department

All appointments in the League's field organization are made by the proper S.C.M., elected by members in each Section listed. Mail your S.C.M. (on the 16th of each month) a postal covering your radio activities for the previous 30 days. Tell him your DX, plans for experimenting, results in 'phone and traffic. He is interested, whether you are an A.R.R.L. member or get your QST at the newsstands; he wants a report from every active ham. If interested and qualified for O.R.S., O.P.S. or other appointments he can tell you about them, too.

Eastern Pennsylvania Maryland-Delaware-District of Columbia Southern New Jersey Western New York Western Pennsylvania	W3QP W3BAK W3BEI W8CSE W8CFO	ATLANTIC DIVISION John Buck Morgan Edgar L. Hudson W. W. Filson Ed Preston Kendall Speer, Jr.	Blue Bell Laurel, Delaware Audubon Tully Lower	
Illinois Indiana Kentucky Michigan Ohio Wisconsin	W9KJV W9QG W9AR W8DPE W8AQ W9UIT	CENTRAL DIVISION L. John Huntoon Noble Burkhart Darrell A. Downard Harold C. Bird E. H. Gibbs Aldrich C. Krones	327 Brandon Ave. R. 4, Box 1 116 N. Longworth Ave. R.F.D. 2 405 Broad St. 3288 S. Illinois Ave.	Glen Ellyn Indianapolis Louisville Pontiac Wadsworth Milwaukee
North Dakota South Dakota Northern Minnesota Southern Minnesota	W9RZA W9VOD W9IGZ W9DCM	DAKOTA DIVISION Ernest Bloch Dr. A. L. Russell Edwin L. Wicklund Webster F. Soules	Box 202 R.F.D. 3 3549 36th Ave., So.	Thompson Wall Kensington Minneapolis
Arkansas Louisiana Mississippi * Tennessee	W5ABI W5DKR W5GHF W4DEP	DELTA DIVISION H. E. Velte Eugene H. Treadaway Robert E. Barr B. G. Lowrey Smith	4415 West 12th St. 2749 Myrtle St. 673 Hillcrest St.	Little Rock New Orleans Lucedale Memphis
Eastern New York N. Y. C. & Long Island Northern New Jersey	W2LU W2AZV W2GMN	HUDSON DIVISION Robert E. Haight E. L. Baunach Fred C. Read	511 South Holmes St. 102 Central Ave. 1014 North Ave.	Scotia Massapequa, L. I. Elizabeth
Iowa * Kansas Missouri Nebraska	W9LEZ W9PB W9OUD W9FAM	MIDWEST DIVISION Phil D. Boardman Harry F. Legler Miss Letha Allendorf Samuel C. Wallace	325 Kirkwood Blvd. 304 Miami St. 1015 W. 3rd St. Green St.	Davenport Hiawatha Joplin Clarke
Connecticut Maine Eastern Massachusetts Western Massachusetts New Hampshire Rhode Island Vermont	W1CTI W1FB W1TWC W1IAH W1BFT W1HRC W1GNF	NEW ENGLAND DIVISION Frederick Ellis, Jr. Winfield A. Ramsdell Sam Gross William J. Barrett Carl B. Evans Clayton C. Gordon Alvin H. Battison	19 Merrill Rd. 1188 Washington Ave. Pleasant St. 239 Columbia St. 80 No. State St. 192 Washington Ave. 1 Central St.	Norwalk Portland Marshfield Hills Adams Concord Providence Windsor
Alaska Idaho Montana Oregon* Washington	K7ENA W7EMT W7FL W7PNO W7FCG	NORTHWESTERN DIVISION Leo E. Osterman Carl Eichelberger G. A. Woodhouse J. R. MacManiman W. Beale	Customhouse Route 2 Holter Dam 1545 N. E. 48th Ave. R. 4, School Ave.	Wrangell Kuna Wolf Creek Portland Walla Walla
Hawaii* Nevada Santa Clara Valley East Bay San Francisco Sacramento Valley Philippines San Joaquin Valley	K6QQE W6BIC W6FBW W6TTY W6SG W6GZY KA1GR W6LPE	PACIFIC DIVISION Harold C. Smith Edward W. Heim Elbert Amarantes Harold J. Burchfield Alan D. Whittaker, Jr. J. L. C. Buckenham George L. Rickard Angelo V. Astone	P. O. Box 150 509 Claremont St. 454 Washington St. 2340 106th Ave. 79 Elmor Ave. 2931-24th St. Box 849 729 Safford	Honolulu Reno San Jose Oakland Mill Valley Sacramento Manila Fresno
North Carolina South Carolina Virginia West Virginia	W4OG W4BOE W3UVA W8HD	ROANOKE DIVISION H. S. Carter Ted Ferguson Charles M. Waff, Jr. C. S. Hoffmann, Jr.	P. O. Box 111 1213 College St. 3101 Park Ave. 47 Lynwood Ave.	Winston-Salem Columbia Richmond Wheeling
Colorado Utah-Wyoming	W9FA W7COH	ROCKY MOUNTAIN DIVISION Glen Glasscock Pownsend J. Rigby	2164 So. Corona St.	Denver Midwest, Wyoming
Alabama Eastern Florida Western Florida Georgia-Cuba-Isle-of-Pines-Porto Rico-Virgin Islands	W4DGS W4DVO W4BSJ *W4PM	SOUTHEASTERN DIVISION James F. Thompson L. A. Connolly Ellis R. Curry Charles W. Davis	102 Narrow Lane Rd. 719 So. Willow Ave. Box 425 2136 N. E. Boulevard Dr.	Montgomery Tampa Madison Atlanta, Ga.
Los Angeles Arizona San Diego	W6GXM W6KFC W6JRM	SOUTHWESTERN DIVISION Don M. Draper Victor C. Clark Howard K. Breedlove	4421 West 63 St. 747 E. Polk St. R. 2, Box 656	Los Angeles Phoenix San Diego
Northern Texas Oklahoma Southern Texas New Mexico	W5DXA W5CEZ W5BHO W5CGJ	WEST GULF DIVISION Lee Hughes Carter L. Simpson Dave H. Calk Joseph M. Eldodt	125 N. Main St. 2010 So. 4th St. 6726 Ave. Q	Childress Ponca City Houston Chamita
Maritime	VE1DQ	MARITIME DIVISION A. M. Crowell	69 Dublin St.	Halifax, N. S.
Ontario	VE3SG	ONTARIO DIVISION Fred H. B. Saxon	302 Lee Ave.	Toronto, Ont.
Quebec	VE2EE	QUEBEC DIVISION Stan Comach	780 Brault Ave.	Verdun, P. Q.
Alberta British Columbia	VE4GE VE5HP	VANALTA DIVISION C. S. Jamieson J. Hepburn, Jr.	581 W. Riverside Drive 335 Foul Bay Road	Drumheller, Alta. Victoria
Manitoba Saskatchewan	VE4BG VE4SY	PRAIRIE DIVISION A. J. R. Simpson Arthur Chesworth	635 Garfield St. 1071 4th Ave., N. W.	Winnipeg Moose Jaw

* Officials appointed to act until the membership of the Section choose permanent S.C.M.'s by nomination and election.

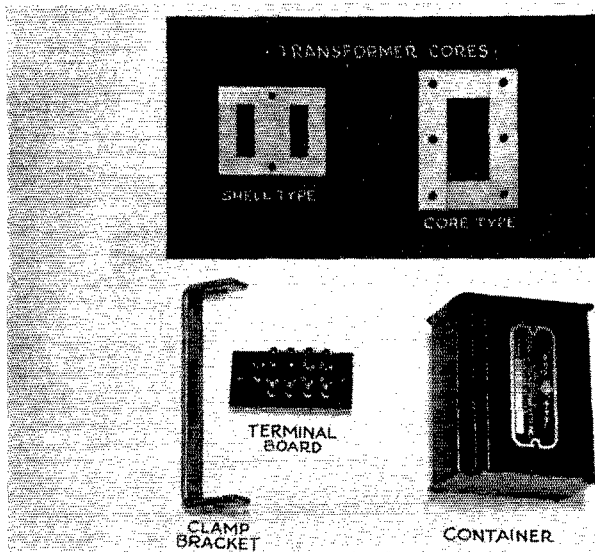

Kandid Ken-O-Talk, No. 7

• MATERIAL (b) •

CONTINUING our Kandid Ken-O-Talk No. 4 in the March issue of *QST*, let us further discuss materials entering into the manufacture of transformers.

There are two types of steel transformer cores. One is shell type, the other core type. The shell type has a middle leg twice the area of the outside legs, sometimes referred to as E and I type core. The core type core is in the shape of a rectangle with each leg having the same cross-section area. Humbucking transformers employ this latter type core. To insure low core losses the best grade of silicon steel is used in making these cores which only has .72 to .86 watts loss per pound.

Clamps are used to hold the stacks of the laminations. These clamps vary from light bar brackets to heavy angle iron, depending upon the size and type of transformer.

Terminal Boards: Considerable time and care has been taken to develop a board having a symmetrical layout and a substantial solder lug to which leads may be soldered in a workmanlike manner, yet permitting it to be connected and disconnected many times without affecting its original sturdiness. The terminals have been carefully placed depending upon the voltage necessary for each unit. These boards are made of bakelite thoroughly dried and impregnated in varnish to reduce any surface creepage. If connections are made with the solder furnished with each transformer (never use acid or paste) they will withstand any normal operating condition encountered.

We have recently developed a new terminal similar to the old type terminal but with two extra prongs at the bottom of the slot so that the wire may be laid in a loop over the terminal and soldered to the original wire and lug at the same time and not slide down the terminal toward the board.

Containers: These containers are all die made and formed from sheet steel and are of a uniform design, 10 in all. They lend themselves to either top chassis mounting with leads all concealed under the chassis or breadboard layout with leads connected in the usual manner or directly in the shelf of the rack above. All containers have mounting holes with eyelets that will pass a 8/32 screw and the larger ones 3/16" to 1/4". They are all spot welded and do not depend upon screws to hold them together.

F. P. Kenyon

The American Radio Relay League



THE AMERICAN RADIO RELAY LEAGUE, INC., is a non-commercial association of radio amateurs, bonded for the promotion of interest in amateur radio communication and experimentation, for the relaying of messages by radio, for the advancement of the radio art and of the public welfare, for the representation of the radio amateur in legislative matters, and for the maintenance of fraternalism and a high standard of conduct.

It is an incorporated association without capital stock, chartered under the laws of Connecticut. Its affairs are governed by a Board of Directors, elected every two years by the general membership. The officers are elected or appointed by the Directors. The League is non-commercial and no one commercially engaged in the manufacture, sale or rental of radio apparatus is eligible to membership on its board.

"Of, by and for the amateur," it numbers within its ranks practically every worth-while amateur in the nation and has a history of glorious achievement as the standard-bearer in amateur affairs.

Inquiries regarding membership are solicited. A bona fide interest in amateur radio is the only essential qualification; ownership of a transmitting station and knowledge of the code are not prerequisite. Correspondence should be addressed to the Secretary.

HIRAM PERCY MAXIM, FIRST PRESIDENT

OFFICERS

President.....EUGENE C. WOODRUFF, W8CMP
State College, Pa.

Vice-President.....GEORGE W. BAILEY, W1KH
Weston, Mass.

Secretary.....KENNETH B. WARNER, W1EH
West Hartford, Connecticut

Treasurer.....ARTHUR A. HEBERT, W1ES
West Hartford, Connecticut

Communications Mgr....F. EDWARD HANDY, W1BDI
West Hartford, Connecticut

General Counsel.....PAUL M. SEGAL
1026 Woodward Building, Washington, D. C.

Address all general correspondence to the administrative headquarters at West Hartford, Connecticut

DIRECTORS

President
EUGENE C. WOODRUFF.....W8CMP
234 W. Fairmount Ave., State College, Pa.

Vice-President
GEORGE W. BAILEY.....W1KH
74 Webster Road, Weston, Mass.

Canadian General Manager
ALEX REID.....VE2BE
169 Logan Ave., St. Lambert, P. Q.

Atlantic Division
WALTER BRADLEY MARTIN.....W3QV
Box 612, Roslyn, Pa.

Central Division
R. H. G. MATHEWS.....W9ZN
100 East Ohio St., Chicago

Dakota Division
FRED W. YOUNG.....W9MZN
228 1/4 Willard St., Mankato, Minn.

Delta Division
E. RAY ARLEDGE.....W5SI
P. O. Box 286, Pine Bluff, Ark.

Hudson Division
KENNETH T. HILL.....W2AHC
115 Willow St., Douglaston, L. I., N. Y.

Midwest Division
FLOYD E. NORWINE, JR.....W9EFC
120 South Fourth St., St. Louis, Mo.

New England Division
PERCY C. NOBLE.....W1BVR
37 Broad St., Westfield, Mass.

Northwestern Division
RALPH J. GIBBONS.....W7KV
c/o United Air Lines, Pendleton, Ore.

Pacific Division
J. L. McCARGAR.....W6EY
66 Hamilton Pl., Oakland, Calif.

Rosnoke Division
H. L. CAVENESS.....W4DW
State College Station, Raleigh, N. C.

Rocky Mountain Division
EDWARD C. STOCKMAN.....W9ESA
618 So. Williams St., Denver

Southeastern Division
BENNETT R. ADAMS, JR.....W4APU
1512 Grove Place, Homewood, Ala.

Southwestern Division
CHARLES E. BLALACK.....W6GG
443 Main St., El Centro, Calif.

West Gulf Division
WAYLAND M. GROVES.....W5NW
c/o Humble Pipe Line, Mt. Pleasant, Texas



"It Seems to Us — —"

IT'S an encouraging thing about amateur radio that most of its institutions are the product of self-evolution. Normally the fraternity is as exclusive as an oyster so far as mass acceptance of untried and unproven schemes is concerned. But every now and then a bit of grit gets inside the oyster, in the form of a worthwhile new idea, and it irritates the mass consciousness until eventually a pearl of considerable value has evolved.

Such a process lies behind the annual A.R.R.L. Field Day, the sixth running of which is announced elsewhere in this issue. As originally introduced in 1933, in response to a considerable spontaneous demand of an international character, this project had two basic purposes: the encouragement of summer amateur activity through combining the call of the outdoors with ham operating, and the enhancement of international work between portable stations in the field—adding another handicap to an already difficult game.

Through the succeeding years its character has changed somewhat, and new objectives—and additional benefits—have evolved. The course of that evolutionary process is a fascinating commentary on the democratic self-adjustments by which amateur radio has through the years governed itself and thereby thrived and grown.

Now, the primary purpose of Field Day is the "testing in actual operation of sending and receiving equipment that will function self-powered." Its further purpose is the inculcation of good operating practices and procedures which will make the operator efficient should actual need for public service of a similar character arise.

These objectives are, naturally, predicated on the development of amateur radio as an emergency communications reserve. As has been pointed out, to a great extent they were not premeditated. They have developed more or less extemporaneously, as emergency-consciousness assumed an increasing importance in the amateur psychology. And they are thereby practical, realistic manifestations of a self-felt need in the ham game seeking its own fulfillment.

The plain fact is that it is only through such self-evolved modes that amateur radio achieves practical service. No movement on the part of a minority to impose however superficially meritorious a plan on the majority has ever succeeded. We do not have dictation in amateur radio, either by individuals or by isolated groups of lofty thinkers remote from practicalities. The progress of amateur radio derives from earthy forms, from sweat-beaded experience and the lessons learned by doers.

All of which is another way of pointing out that any effort to *order* hams to build emergency gear auxiliary to their ham rigs, to test that gear under practical conditions and to engage in rigorous operating training, would be a colossal failure. But mix these worthy aims with a whale of a lot of fun—make the whole experience a glorious outing—combine picnics and portables—and you have one of the most successful and thoroughly enjoyed ham activities of the entire calendar.

There's no question about it—Field Day is more fun than a barrel of monkeys. It combines the competitive zest of the Sweepstakes, the DX thrill that comes only with low-power work, the glow of technical pride that comes from a difficult engineering feat successfully accomplished—it combines these and mixes in liberal doses of fresh air, sunshine (we hope!), fauna, flora and all the other concomitants of picnicking, camping and general summer good-time-having. There's nothing else like it; if you miss it, you're missing far, far too much.

As for the utilitarian side—well, talk with any group of participants in recent hurricane, flood or other emergencies, and you'll find they give plenty of credit to the "painless preparedness" in both gear and operating practice afforded by Field Day activity. It's the easiest road to adequate preparation there is—and a swim after a six-hour operating trick isn't a bad feeling, either.

CQ FD, then, and cu June 11th–12th.

—C. B. D.

Gang Tuning for the Multi-Stage Transmitter

A Simple Tracking System Reducing the Number of Necessary Controls

By Don H. Mix,* WITS

THERE was a time when most amateurs were content with operation in only one of the several amateur bands. This is not true to-day. Most amateurs now realize the increased utility and pleasure which may be derived from a transmitter which may be operated at will in any of the bands assigned for amateur use. Depending upon conditions and circumstances, we can select the particular band most suited to the work at hand. We can go to 1.75 Mc. for a local rag-chew to 3.5 Mc. for a bit of traffic handling, to 7 Mc. for coast-to-coast work or night time DX and to 14 or 28 Mc. for daytime contacts over long dis-

station we desire to contact, we can, with a little study and judgment, quite frequently tune our transmitter to that receiver. This may seem an awkward way of doing the job, but it accomplishes the desired result. In general operation, it is frequently possible to side-step bad QRM providing it is possible to get the idea across to the other fellow.

Many traffic nets and trunk lines find it desirable to operate on spot frequencies and yet a single outside signal of moderate strength can put the entire net out of commission if the net is crystal controlled. With the introduction of flexibility in

frequency, the entire net may follow the net control station to a free channel in case of persistent interference. Net efficiency might be improved by keeping the n.c.s. receiver tuned to one frequency on which all stations report into the net, are dispatched in groups to various neighboring frequencies for exchange of traffic and then report back to the n.c.s. on his frequency when clear for further instructions.

Complete flexibility in transmitting frequency involves certain problems which may not become evident until they pop up in practical operation. In using

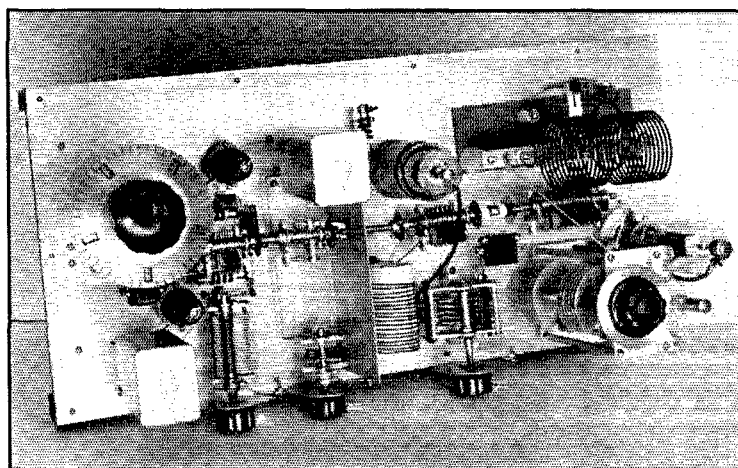

FIG. 1.—THE LINE OF GANGED TUNING CONDENSERS RUNNING THROUGH THE CENTER OF THE CHASSIS IS CONTROLLED BY THE SINGLE PW DIAL. The band-setting condensers are along the front edge.

tances. Few transmitters are now incapable of covering at least the three most common bands of 3.5, 7 and 14 Mc. Systems of plug-in coils for changing bands have been in use for many years and the conversion to some type of rapid and convenient band-switching is increasing steadily.

To those of us who consistently engage in practical operation, it is becoming more and more evident, however, that the ability to select at will any frequency within a band is perhaps even more important. The advantages of complete flexibility in frequency adjustment are too numerous to cover in detail. One of the foremost is that, while we cannot control the tuning of the receiver at the

e.c.o., we still find it necessary to employ the usual number of frequency-doubling and power-gaining stages. Small changes in frequency may be made by adjustment of the oscillator circuit only, but with large changes in frequency comes the realization that a multitude of circuits requires retuning. This seldom becomes a factor with crystal control because frequency is not likely to be changed so often. Once having acquired complete freedom in selection of frequency, however, it is surprising how many occasions arise for rapidly changing frequency over a wide range. This is particularly true in most contests.

Aside from the inconvenience of retuning several stages, we must remember that tubes in the

* Technical Department, QST.

transmitter may take a severe beating during the process of tuning up and only because the process usually is infrequently necessary will tubes stand up well under the punishment. These problems point toward ganged tuning for the transmitter, and we now wonder why it has not been common practice long before. Compared with the problem of tracking a superheterodyne, the job should be easy.

Accordingly, we began to look into the various aspects of the problem several months ago. We finally selected the tracking scheme shown in the circuit diagram. It was suggested by W1JPE and is similar to the tracking systems used in certain communications superhets. An adjustable padding condenser is connected across the entire tank coil in each stage to tune each circuit to the high frequency end of each band. The tuning condensers, which are ganged together, are connected across a portion of the coil which will permit tuning across the band desired. In case anyone becomes scared at this point, we hasten to say that the adjustment is simplicity itself. The arrangement is capable of perfect tracking

across any amateur band. The only snag encountered occurred, as might be expected, in the antenna coupling and tuning circuits. So far, no satisfactory method of ganging in this portion of the circuit has been found. Tracking of oscillator and amplifier circuits is well worth while, however, because the number of controls may always be reduced to a maximum of three regardless of the number of stages in the transmitter. An accurate tracking system is superior to a system of band-pass coupling because there is no sacrifice in efficiency. This may not be important where pentodes or beam tubes requiring little excitation are concerned, but when triodes are used, the loss becomes serious.

ELECTRON-COUPLED OSCILLATORS

Before continuing with details of the transmitter, it might be well to pause a moment while we give some further thought to e.c.o.'s in general. The article which appeared in *QST* for April, 1936, pointed out several precautions which are necessary to obtain satisfactory frequency stability. The grid-ground circuit should

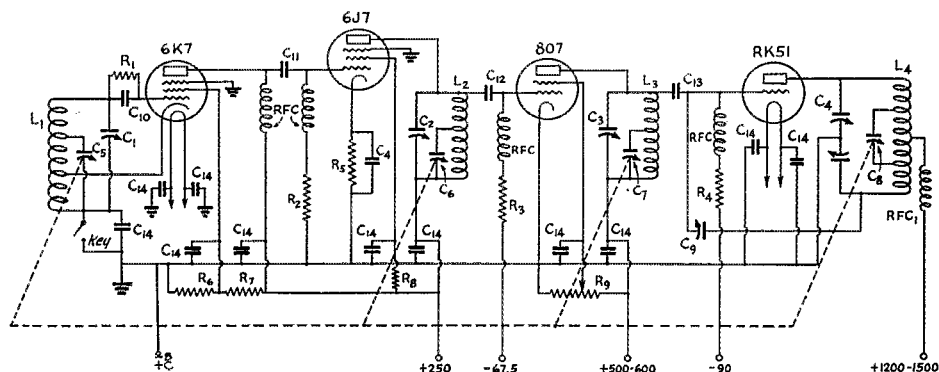

FIG. 2—CIRCUIT DIAGRAM OF THE MULTI-STAGE TRANSMITTER

- | | | |
|---|---|--|
| C ₁ —320- μ fd. max. oscillator padder (Hammarlund MC325M). | C ₁₀ —250- μ fd. mica, oscillator grid condenser. | R ₃ —50,000-ohm, 1-watt, doubler grid leak. |
| C ₂ —50- μ fd. max. buffer padder (Hammarlund MC50M). | C ₁₁ —250- μ fd. mica buffer coupling condenser. | R ₄ —5000-ohm, 10-watt, final grid leak. |
| C ₃ —50- μ fd. max. doubler padder (Cardwell MT50GS). | C ₁₂ —250- μ fd. mica, 1000-volt rating, doubler coupling condenser. | R ₅ —500-ohm, 1/2-watt, buffer cathode biasing resistance. |
| C ₄ —100- μ fd. per section final padder (National TMC100D). | C ₁₃ —100- μ fd. mica, 2500-volt rating, final coupling condenser. | R ₆ —50,000-ohm, 2-watt, oscillator screen voltage divider. |
| C ₅ —100- μ fd. max. oscillator tuner (Hammarlund MC100M). | C ₁₄ —0.01- μ d., 600-volt paper r.f. by-pass. | R ₇ —25,000-ohm, 2-watt, oscillator screen voltage divider. |
| C ₆ —35- μ fd. max. buffer tuner (Hammarlund MC35M). | R ₁ —0.1 meg., 1/2-watt, oscillator grid leak. | R ₈ —40,000-ohm, 1-watt buffer screen voltage dropping resistor. |
| C ₇ —35- μ fd. max. doubler tuner (Hammarlund MC35MX). | R ₂ —50,000-ohm, 1/2-watt, buffer grid leak. | R ₉ —25,000-ohm, 75-watt with slider, doubler screen voltage divider. |
| C ₈ —35- μ fd. max. final tuner (Bud No. 566). | | RFC—National R100. |
| C ₉ —Neutralizing condenser (National NC800). | | RFC1—National R154. |
- L₁—3.5 and 7-Mc. output—17 t. No. 24, 1" dia., 1" long, tapped at 5th turn from ground, no bandspread tap. 14 and 28-Mc. output—9 t. No. 22, 1" dia., 1" long, tapped at 2 3/4 turns from ground for cathode and 6 turns from ground for bandspread.
- L₂—3.5 and 7-Mc. output—38 t. No. 24 d.c.c., 1" diam. 1 1/8" long, tapped at 33rd turn from ground. 14 and 28-Mc. output—20 t. No. 24 d.c.c., 1" diam., 3/4" long, tapped at 11th turn from ground.
- L₃—3.5-Mc. output—28 t. 1 3/4" diameter, 1 1/2" long, tapped at 24th turn from ground. 7-Mc. output—17 t. 1 3/4" diam., 2 1/4" long, tapped at 13th turn from ground end. 14 and 28-Mc. output—8 t., 1 3/4" diam. 2 1/2" long, tapped at 3 1/4 turns from ground end.
- L₄—3.5 Mc.—34 t., 2 1/2" diam., 3 1/2" long, tapped at 10 3/4 turns each side of center. 7 Mc.—22 t., 2 1/2" diam., 4" long, tapped at 6 turns each side of center. 14 Mc.—12 t., 2 1/2" diam., 4" long, tapped at 2 turns each side of center. 28 Mc.—6 turns, 2 1/2" diam., 5" long, tapped at approximately 6/10 turn each side of center.

have a high value of capacity, the ratio of plate to screen voltage should be carefully adjusted, the oscillator should be loaded lightly, the power supply should be well filtered and power supply leads well by-passed for r.f., the oscillator circuit should be well shielded, the plate circuit may require critical adjustment in tuning and the oscillator should be mounted so as to be free from mechanical vibration. Experience over the last year or two has shown that the last two mentioned are often sources of greatest annoyance.

A Type 802 had been used previously in the e.c.o. upon the theory that greater power output could be obtained with less heating and consequent frequency drift from a tube with large elements. This theory was borne out in practice, but large elements are susceptible to mechanical vibration and, once the vibration is set up, it will continue for an appreciable length of time. Recent experiments with various tubes in other transmitters have shown that tubes of the receiving type with shorter, more firmly supported elements are much superior in this respect. The metal types 6J7 and 6K7 are particularly good. With a good specimen in the oscillator, a sharp blow on this chassis will produce only an instan-

regulation is strongly recommended for these first two stages. Extreme care should be used in stabilizing succeeding amplifier stages since any tendency toward parasitic oscillation is quite apt to be reflected back into the oscillator in the form of modulation.

CIRCUIT DETAILS

The remainder of the circuit was made up merely for the purpose of testing the tracking in a typical arrangement. The 807 beam tube or a pentode capable of operating with a small amount of excitation is quite essential, however.

It will be noticed that the circuit is strictly conventional and that the only additional equipment required is the row of midget condensers ganged together with flexible shaft couplings. These may be seen in the photographs, running through the approximate center of the chassis. The type PW dial, or something similar, is a necessity since the load of several condensers is too great for an ordinary friction dial. Only condensers of certain manufacturers are at present equipped with tail shafts so that they may be ganged and these only in the midget types. Condensers of these types with fairly good plate spacing are obtainable.

The spacing does not have to be as great as might be first expected because the tuning condensers are connected across only a portion of the total r.f. voltage developed across the tank coil. Those listed below the circuit diagram have the best spacing of any we could find and should not break down in circuits of tubes operating at plate voltages of 1000 to 1200. If the demand becomes sufficient, we shall probably see larger condensers with tail shafts before long. It should be remembered that the one in the final

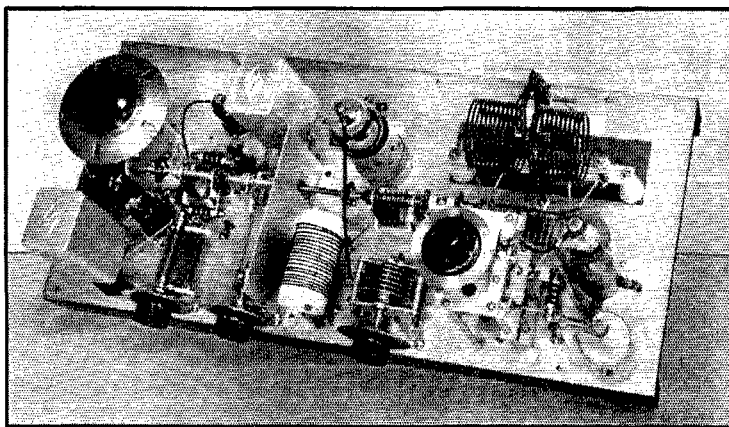

FIG. 3—THE CHASSIS IS SUFFICIENTLY SMALL TO PERMIT ITS USE ON THE OPERATING TABLE NEAR THE RECEIVER, ALTHOUGH IT WAS ORIGINALLY DESIGNED FOR VERTICAL MOUNTING

taneous "ping," and most vibration to which a transmitter is ordinarily subjected seems to have little or no effect upon the frequency stability. If a pentode or beam tube is used in the stage following the oscillator, sufficient excitation will be obtained with inputs so low as to cause negligible frequency drift from heating.

The second difficulty is overcome in this transmitter by the use of untuned impedance coupling between the plate of the oscillator and the grid of the low-power buffer stage. Thus, the number of necessary controls remains the same. A separate power supply, well filtered, with good voltage

regulation is strongly recommended for these first two stages. Extreme care should be used in stabilizing succeeding amplifier stages since any tendency toward parasitic oscillation is quite apt to be reflected back into the oscillator in the form of modulation.

Again referring to the photographs, the transmitter is assembled on a half-inch wood base 12 inches wide by 25 inches long. This base is covered with a thin sheet of aluminum fastened along the edges with heavy escutcheon pins and is mounted on a pair of 1-inch by 2-inch strips running the length of the base to provide a space underneath for low potential equipment. All r.f. wiring is carried above the base with rigid No. 14 wire.

Starting at the left-hand end of the transmitter, the oscillator coil is contained in the shield can directly in front of the main tuning dial with the oscillator tube, grid condenser and leak, padding and tuning condensers immediately alongside. Both oscillator and buffer coils plug into National CIR type sockets mounted on substantial stand-off insulators. These sockets provide firmer mountings for the coils than most other types. The metal tube in the rear is the 6J7 buffer. A vertical baffle shield separates the buffer plate coil and condensers from those of the 807 stage. Complete shielding of the 807 is of the utmost importance if oscillation is to be avoided. The plate lead must be shielded from the input leads inside the tube. This is accomplished by means of a two-section cylindrical shield made up from parts of two National type T58 receiving tube shields. One section extends downward from the surface of the CIR socket to the base, while the other extends upward from the socket surface to a level equal to that of the lower ceramic supporting disk inside the tube. The plate coil for the 807 is wound on a National XR13 form.

All condensers except the split-stator condenser are mounted on small Johnson stand-off insulators. The rotors of the split-stator condenser are grounded so it may be mounted directly on the metal base. The neutralizing condenser may be seen directly in front of the RK51. The plate tank coils in the final amplifier are of the Barker and Williamson TVL series. Only the 3.5-Mc. coil needs pruning. Several turns were removed from each half of the winding to permit the use of a higher capacity at this frequency.

Care should be used in obtaining the best shaft alignment possible in mounting the ganged condensers. Flexible shaft couplings with fiber insulation will be satisfactory for low-power stages, but one with ceramic insulation should be used between tuning condensers of the last two stages.

All low-potential wiring is carried beneath the base with wire suitable for the purpose. Filament wires for the final should not be smaller than No. 16 and the high voltage leads for the 807 and RK51 should be well insulated. Mounting screws protruding through the baseboard make handy ground connections. Be sure, however, that any screws so used make good connection to the metal sheet. The large resistor in the lower center is the voltage dividing resistor for the 807 screen voltage. A terminal strip is provided at the left or bottom edge of the base.

GANGING ADJUSTMENTS

Returning to the oscillator circuit, plug-in coils are provided for the 3.5- and 7-Mc. bands. Since

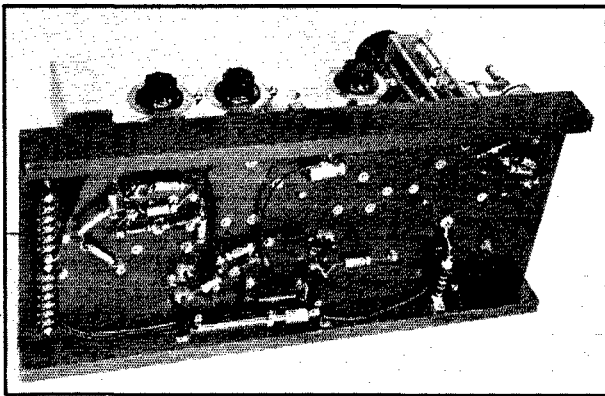

FIG. 4—UNDERNEATH VIEW SHOWING LOW POTENTIAL WIRING, RESISTANCES AND BY-PASS CONDENSERS

only one doubler stage is provided in this particular transmitter, the oscillator is operated at 3.5 Mc. for the 3.5- and 7-Mc. bands and at 7 Mc. for the 14- and 28-Mc. bands, doubling frequency in the output stage for the latter. The 3.5-Mc. oscillator coil is wound to tune to the high-frequency end of the band with the high- C padder C_1 set near maximum capacity. With the 100- μ fd. tuning condenser C_2 connected across the entire coil, the oscillator will just about cover the band. If it does not cover the band, a turn or two should be added to the coil and the capacity of C_1 reduced to tune to the high-frequency end of the band. This will increase the frequency range of the tuning condenser. With the oscillator running as it should and covering the desired frequency range, we next turn our attention to the buffer plate coil. Here, again, we make the coil of such a size that the padder C_2 will tune the circuit to the high-frequency end of the band with a reasonable amount of capacity, say 40 to 50 μ fd. for this band. We then place the tuning tap C_3 at the point specified in the coil table. With the coil in place and the 807 in the socket with heater running, the oscillator is tuned to the high-frequency end of the band. The padder, C_2 , is then tuned for resonance as indicated by the dip in plate current. The frequency control dial is then rotated to bring the circuits to the low-frequency end of the band. Now C_2 should be adjusted very carefully to determine if the buffer plate circuit is still at resonance. If it is not, it should be carefully noted whether an increase in capacity or decrease in capacity is necessary to bring it back to resonance. If the padder capacity must be increased, it indicates that the tuning or bandspread condenser is not tuning fast enough and, therefore, it must be connected across a greater portion of the coil. On the other hand, if the padder capacity must be decreased to bring the circuit to resonance, the tuning condenser is tuning too rapidly and, therefore, the tap must be

(Continued on page 78)

The Extended Double-Zepp Antenna

Simple Antenna Structures Having Improved Gain and Horizontal Directivity

By Hugo Romander,* W2NB

THE questions of antenna directivity and antenna "gain" are becoming increasingly popular in discussions on antenna systems among amateurs, and it would therefore seem proper to preface an article dealing with directive antenna arrays with a warning, or perhaps a reminder, that one cannot have high gain and radiate in all directions at the same time. To most amateurs this is an obvious fact, but it may not be as well known that this principle is almost equally important in the vertical plane. Those of us fortunate enough to have available large open spaces in which to hang wires will find long-wire antennas, such as the "V" and the horizontal diamond, the easiest way to obtain

practical antenna for a variety of distances is one with a fairly wide radiation pattern in the vertical plane.¹ The "stacking" of elements or the

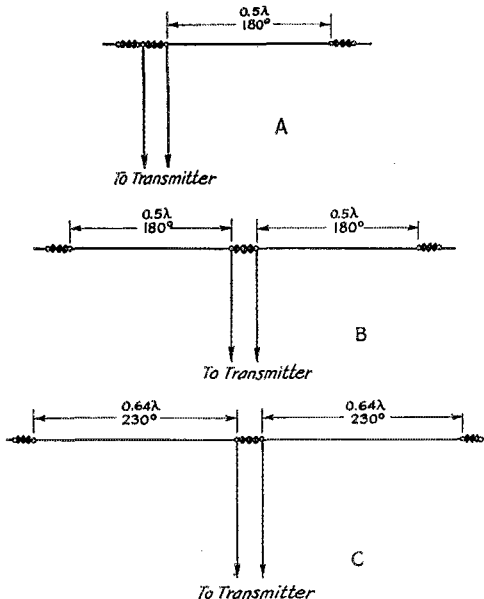

FIG. 1—BASIC ANTENNA CONFIGURATIONS
A—The half-wave Zepp; B—Double Zepp or "two half-waves in phase"; C—Extended double Zepp.

high gain, but the radiation from such antennas is restricted in the vertical plane fully as much as in the horizontal plane. The result may well be that in the very direction such an antenna is supposed to work best, a simple horizontal doublet will put in a far better signal at certain distances.

It would seem, therefore, that the most

* 200 Mt. Pleasant Avenue, Newark, N. J.

¹ Although this viewpoint appears to be opposed to that

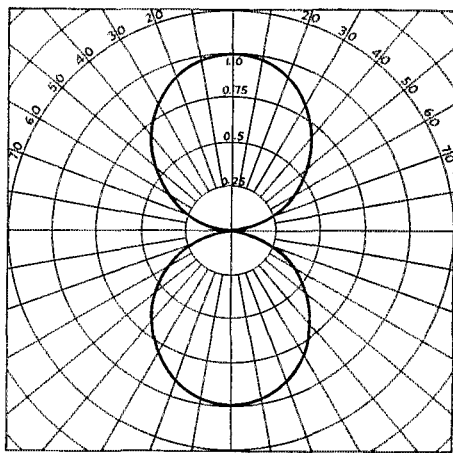

FIG. 2—HORIZONTAL PATTERN (RELATIVE FIELD STRENGTH) OF A DOUBLET HALF-WAVE ANTENNA

use of long wires is not recommended for distances under 1000 miles, except for the very short distances normally reached by the ground wave. The most universal high-gain antenna must restrict its radiation in the horizontal plane only, and its height above ground must also be considered to obtain the best compromise in the vertical plane. It is the purpose of this article to discuss the merits of a simple antenna array which combines these desirable features.

THE DOUBLET

Let us discuss, first, the simple doublet, since this antenna will serve admirably as our basis of reference or comparison. To be more specific, consider this doublet as suspended horizontally

expressed in the article "Simple Directional Arrays Using Half-Wave Elements," by N. C. Stavrou, in May, 1938, *QST*, there is no actual conflict. As the present author points out, the broad vertical characteristic is to be preferred when the antenna is to give optimum results over short as well as long distances; the former article was concerned with long-distance transmissions, where the lowest possible angle gives best results under nearly all conditions. The type of work to be carried on naturally will be a determining factor. In any event, the simpler structures are not likely to be too sharp in either plane for satisfactory general work.—EDITOR.

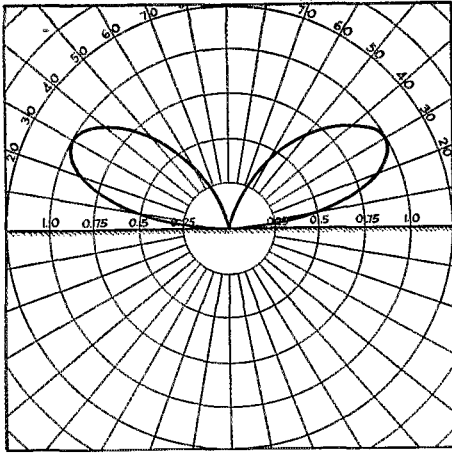

FIG. 3—VERTICAL-PLANE PATTERN FOR A HORIZONTAL ANTENNA, $\frac{1}{2}$ -WAVE ABOVE PERFECT EARTH IN DIRECTION OF MAXIMUM RADIATION

and fed at one end in the time-honored fashion of the Zepp feeder, as in Fig. 1A. Ignoring, for the moment, the fact that the open-ended feeder wire will be at somewhat higher potential than the other feeder wire and will therefore radiate, the horizontal radiation pattern about this doublet, if you're lucky, will be about as shown on Fig. 2. Of course, it is assumed the antenna is sufficiently remote from power-line wires and house plumbing to be unaffected by such linear conductors, since our problem is complicated enough without having to consider the mutual impedance between our doublet and the neighbor's b.e.l. antenna!

This pattern of the horizontal doublet is, no doubt, familiar to most amateurs. Less familiar, perhaps, is the vertical radiation pattern (in the direction of maximum horizontal radiation) as shown in Fig. 3. Here it is assumed that the height of the doublet above ground is one-half wavelength and that the earth has perfect conductivity. Fortunately, even the relatively low-conductivity soil and sand on Long Island reflects a high percentage of the horizontally-polarized waves radiated at angles less than 50° to the earth's surface. Such reflected waves, combining with the direct radiation from the antenna within the range of vertical angles in which we are most interested, are responsible for a maximum gain of nearly 6 db over the same doublet in "free space"; that is, without the presence of the earth.

This gift of 6 db must not be taken too much for granted, however. Consider the fact that most amateur communications at high frequencies utilize vertical angles ranging from 10 degrees to 50 degrees. That 6 db must, therefore, come from radiations reflected from the earth's surface quite some distance from the doublet, and in the desired direction of transmission. If the ground

slopes sharply upward, or houses or wires are in this area, it becomes questionable, indeed, whether any great portion of the available 6 db is realized. This is especially true for the lower angles of radiation, but usually nothing can be done about this situation, so let us see if we can make up for our ground reflection losses by increasing the horizontal directivity.

THE DOUBLE-ZEPP

By the simple expedient of attaching another doublet to the open-ended terminal of the Zepp feeder, as in Fig. 1B, and hanging this doublet parallel and coaxial with the original doublet, an appreciable gain may be obtained. The horizontal radiation pattern will be as shown in Fig. 4. The gain should measure about 1.9 db, corresponding to a 55 per cent increase in power. This antenna is widely used among amateurs and is popularly known as the "double-Zepp" antenna, or "two half-waves in phase." A fair amount of gain and a reduction in interfering signals from end-wise directions is easily realized, but the gain is rather disappointing, since it would seem one is entitled to 100 per cent gain in power when doubling the number of radiating members.

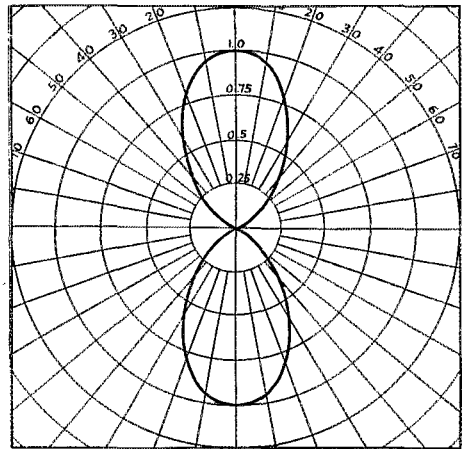

FIG. 4—HORIZONTAL PATTERN OF A DOUBLE-ZEPP OR TWO HALF-WAVES IN PHASE

The reason why only 1.9 db is realized with the double-Zepp is made clear only after a mathematical study of the situation. Briefly, the close proximity of the two doublets causes a mutual coupling between them, and this coupling (mutual impedance) has an adverse effect on the radiation resistance insofar as gain in the broad-side direction is concerned. Obviously, the thing to do is to move the doublets further apart, but this complicates the method of feed. A much simpler way of obtaining increased gain was evolved by Mr. A. A. Alford, of Mackay Radio and Telegraph Company, from the principles

discussed in Mr. G. H. Brown's article on broadcast antennas in the Proceedings of the I.R.E. for January, 1936. Mr. Alford presented this idea in a paper delivered at an I.R.E. meeting in Washington.

EXTENDED DOUBLE ZEPP

The gain of the double Zepp may be increased from 1.9 to 3.0 db by the simple expedient of

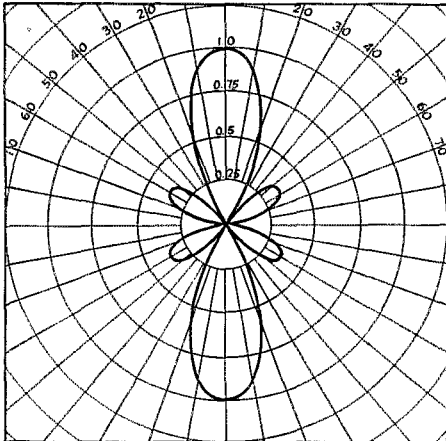

FIG. 5—HORIZONTAL PATTERN OF DOUBLE 230-DEGREE ZEPP

increasing the length of each doublet until its electrical length is 0.64 wavelength instead of 0.5 wavelength. In electrical degrees the double Zepp consists of two 180-degree elements; the extended double Zepp for maximum gain should consist of two 230-degree elements. See Fig. 1C. In this way the power gain may be increased from 55 per cent to 100 per cent. The gain decreases rapidly for extensions beyond 230 degrees, and therefore, when operating over a band of frequencies, each of the two elements should not exceed 240 degrees for the highest frequency. The horizontal pattern for the double 230-degree Zepp is shown in Fig. 5. The vertical pattern in a plane perpendicular to the antenna will be the same as for the simple doublet.

ANTENNA IMPEDANCE

The impedance of this antenna at the termination of the transmission line is of interest, since it has an important bearing on the standing-wave ratio of current or voltage in the line, and it will be compared with that of the ordinary double Zepp. The double 180-degree antenna presents an impedance of approximately 4400 ohms of almost pure resistance as a termination for the transmission line. This value will be slightly affected by the size of wire used in the antenna and, to a moderate extent, by the height above ground or the influence of nearby conductors,

and so the "free space" value is given for No. 14 wire. With this antenna and a 600-ohm surge-impedance line the ratio of maximum to minimum current along the line will be 4400 divided by 600, or 7.3. Incidentally, the terminating resistance of the simple Zepp-fed doublet is about 12,000 ohms, resulting in a standing wave ratio of 20 on our 600-ohm line. For calculation of the surge impedance of the line the reader is referred to *The Radio Amateur's Handbook*.

The impedance at the center of the double 230-degree antenna is not a pure resistance, and hence its effect upon the transmission line will be such that maxima or minima of voltage and current along the line will not be odd multiples of a quarter wave from the antenna, as with the ordinary Zepp or double-Zepp antennas. As might be expected, the current or voltage maxima will be shifted towards the antenna, since the two doublets are longer than normal, and this shift is approximately 0.13 times the wavelength. At any rate, the antenna impedance is such that the equivalent pure resistance at any voltage maximum will be about 6000 ohms; that is, the standing-wave ratio will be 10 on a 600-ohm line.

Knowing the standing-wave ratio, it becomes an easy matter to calculate the input resistance to the transmission line if it was cut, let us say, at any current maximum. Thus, for the simple Zepp-fed doublet, this resistance would be 600 divided by 20, or 30 ohms. For the ordinary double-Zepp antenna this resistance would be 600 divided by 7.3, or 82 ohms. For the double 230-degree antenna this resistance would be 600 divided by 10, or 60 ohms. Those who do not use correcting stubs or other methods to obtain a "flat" line (standing wave ratio of 1), but who cut their transmission lines at the maximum current point after the manner of the "tuned feeder," will find these figures useful in calculating the power output of their transmitters.

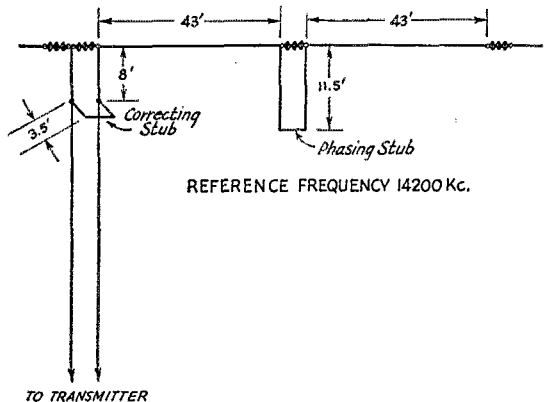

FIG. 6—END-FED DOUBLE 230-DEGREE ZEPP WITH 600-OHM NON-RESONANT TRANSMISSION LINE

FED LINES

However, the use of flat lines, in amateur circles usually referred to as untuned lines, is becoming increasingly popular as their merits are more generally known, and the figures given are essential in calculating the length and position, for example, of a correcting stub, the latter being one of the simplest devices for reducing the standing-wave ratio to unity. A discussion of the use of the correcting stub may be found on page 307 of the *Handbook* (15th edition) where a table indicates the lengths and positions of the stub for various standing-wave ratios. The shorted stub or "loop" will generally be most practical, and some idea of dimensions may be obtained from the fact that when using the double 230-degree Zepp on 14,200 kc. the stub should be 3.5 feet long; that is, it should be composed of the same kind of wire as is used in the transmission line, this wire being 7 feet long and bent to form a U-shaped rectangle with a width equal to the transmission line. At the frequency mentioned, where each extended doublet is 43 feet long, the correct location for the stub will be about 8 feet from the antenna.

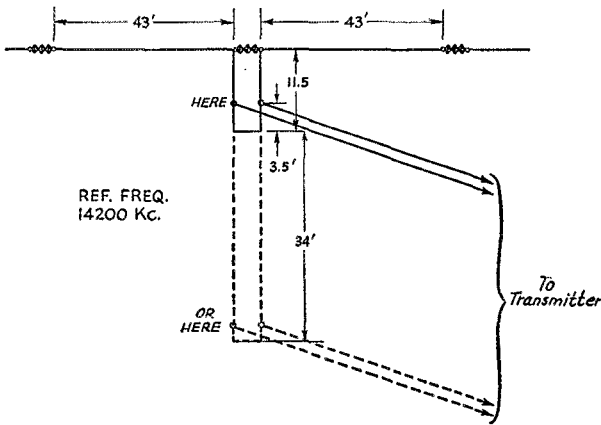

FIG. 7.—CENTER-FED DOUBLE 230-DEGREE ZEPPE WITH 600-OHM TRANSMISSION LINE

Ordinarily the best place to introduce power into an antenna is at a point symmetrically located with respect to the opposite ends of the system. This will not always be practical, because of space limitations, and hence it may become necessary to feed the extended double-Zepp antenna at one end in true Zepp fashion. Some sacrifice in gain will result, due, for the most part, to unequal distribution of current between the two doublets and to radiation from the feeder because it has an unbalanced load. Physical dimensions of feeder, extended doublets, and phasing stub are shown in Fig. 6. Note that the

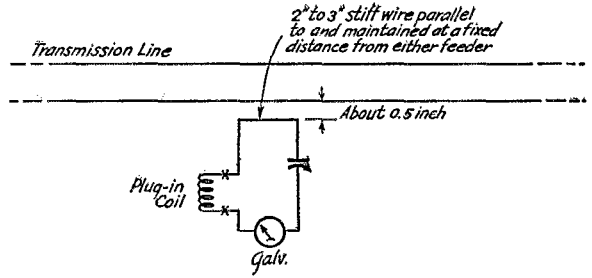

FIG. 8.—PORTABLE LINE-CURRENT INDICATOR

phasing-stub length is shorter than a quarter wavelength, but by an amount not exactly equal to the extension of each doublet beyond a half wavelength. This discrepancy is due to interaction between the doublet wires and the wires of the phasing stub. Again a reference frequency is given to simplify calculation of lengths at other frequencies by inverse proportion. The figures given should be regarded as approximation, and tests made individually to determine dimensions and positions of important elements.

ANTENNA ADJUSTMENTS

One of the most effective methods of adjusting an antenna system is to use the transmitter to excite, at the desired frequency, another antenna stretched out, perhaps temporarily, at least 8 or 10 feet from the ground. This "exciter" antenna should preferably be at least one-half wavelength away from the antenna to be adjusted. If the two are parallel to each other, so much the better. Using the end-fed extended double-Zepp antenna as an example, the first consideration is the length of each doublet, and this brings up the problem of "end-effect." We have approximately solved this by cutting our doublets 5 per cent short of the theoretical length. Actually the end-effect, which normally exists only at the ends of the antenna, depends on

the wire size and the size of the insulator fitting (if metal caps are used), as well as the frequency. Moreover, the end-effect does not vary quite as rapidly as a direct function of the wavelength, so that if an end-effect of 1 foot is correct at 14,200 kc., it is more nearly 1.5 feet than 2 feet at 7100 kc.

The theoretical "uncorrected" length of each half of an extended double-Zepp antenna at 14,200 kc. is 44.3 feet. The end-effect may be no more than 1 foot, but since it is better that the antenna be a little too short than too long, let's make the correction 1.3 feet, so that each half will be exactly 43 feet long. At the center insulator which separates the two halves a "stub" must be connected, if the system is to be end-fed. Now,

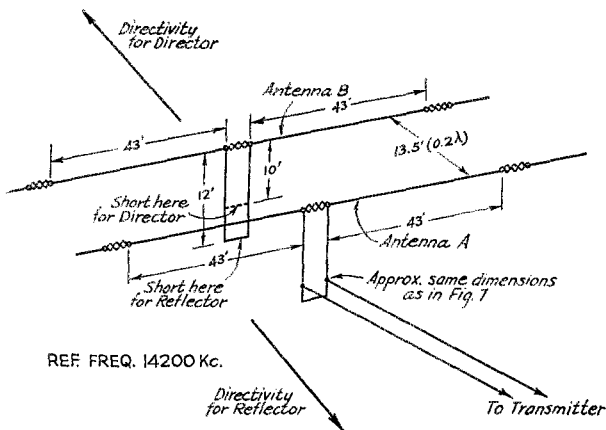

FIG. 9—DOUBLE 230-DEGREE ZEPP WITH PARASITIC REFLECTOR-DIRECTOR

this stub will take the form of a transmission line shorted at the end opposite from the antenna, and for the frequency under consideration its shortest length will be about 12 feet. Since it is our intention to make this transmission line somewhat longer than the anticipated proper position of the short in order to permit locating the correct position by sliding the short up or down, and furthermore since 12 feet will ordinarily not bring the probable correct shorting point at a convenient distance from ground, it will be more practical to add any multiple of a half wavelength (34 feet) to the transmission line and do the shorting experiment at a point along the line accessible from the ground.

With all this done and with the Zepp feeder *not* attached to the main antenna (why not use it to feed the exciter antenna?), power may be fed to the exciter antenna and with a sensitive r.f. instrument connected in the short on the "stub," a position of the short may easily be found where maximum current flows. This assumes that the main antenna has been hauled up into its normal operating position. Note this maximum-current position of the short and measure in exact multiples of one-half wavelength from this point towards the antenna, thus arriving at the nearest point to the antenna at which a short may be placed. This will give the shortest possible center stub. Of course, it is not necessary that the center stub be made that short, since very little loss will be incurred if it is left a half-wave or even a wavelength longer—that is, if the wire is not smaller than No. 14. The Zepp feeders may now be attached to either end of the antenna, as it is now ready for operation.

The method of adjusting the center stub just outlined is also useful where it is desired to feed any of the antenna forms discussed above with an untuned transmission line—that is, a transmission line terminated by its surge impedance. Using the example cited in the previous paragraph, let us assume the point of maximum current through the short has been found and, after soldering a piece of wire across the line at this point, the extra length of transmission line is chopped off. The two-wire line from the transmitter may now be tapped in above this shorted end of the stub, and it is only a question of position of the feeder tap from the shorted end to terminate the line properly. See Fig. 7. This point will be approximately 3.3 feet from the short for a 600-ohm transmission line. Of course, when all this is done, we will have the same transmission line with correcting stub discussed earlier in this article.

LINE-CURRENT MEASURING DEVICES

The same principle holds true for the double-Zepp and for center feeding the simple doublet, the only ambiguous point being that of knowing when the transmission line from the transmitter is connected at the right distance from the closed end of the stub. The transmission line will be properly terminated when there is no appreciable variation in voltage or current along the line, and hence some method must be used which will detect any variation in voltage or current. Simplest of all is the old-fashioned wood-covered lead pencil, for with this device bright arcs may be drawn from either wire and the voltage at any one point judged by comparison with the voltage

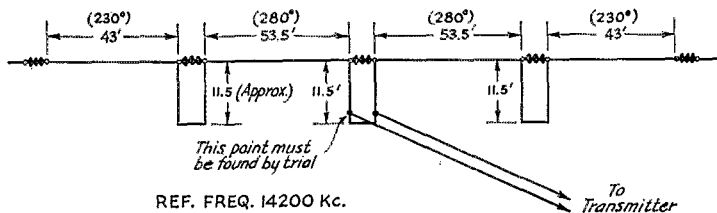

FIG. 10—FOUR-ELEMENT ARRAY WITH 230-DEGREE ELEMENTS

at another point. This method has the disadvantage of being both crude and liable to error due to the presence of second or higher-order harmonics in the output from the transmitter. A little better is the small neon bulb, but this is also a voltage-operated device and subject to harmonic distortion. Then there is the current-squared galvanometer with a few small turns of wire connected to its terminals, these turns being coupled to either line. This device is quite good if

(Continued on page 76)

A C.W. and 'Phone Station Freqmeter-Monitor and Modulometer with Cathode Ray Tube

By S. Leibowitz,* W8BXN

THE conscientious amateur operator endeavors at all times to monitor his transmissions for a two-fold purpose, to stay within the allotted band and to maintain the quality of his signal. Regarding the latter, there is again a two-fold purpose in the case of 'phone transmission—the stability of the r.f. carrier frequency and the quality of the modulation. The well-known heterodyne frequency-meter-monitor has for many years fulfilled effectively the check-up on carrier stability, while for modulation monitoring a number of devices of one type or another have been used. Usually each amateur with a 'phone rig shows his own in-

in the writer's station to perform all necessary monitoring operations from one spot on the operating table and with "finger-tip" control. By a mere throw of a switch the following are available: Electron-coupled frequency-meter monitor, cathode-ray modulometer showing the trapezoidal pattern of the modulated wave and percentage modulation, and a moving-element output meter for observing and controlling modulation peaks. As an instrument for laboratory or test work it also performs as a calibrated radio-frequency generator in the ham bands, an independent cathode-ray oscilloscope, an output meter and a db meter. The complete instrument

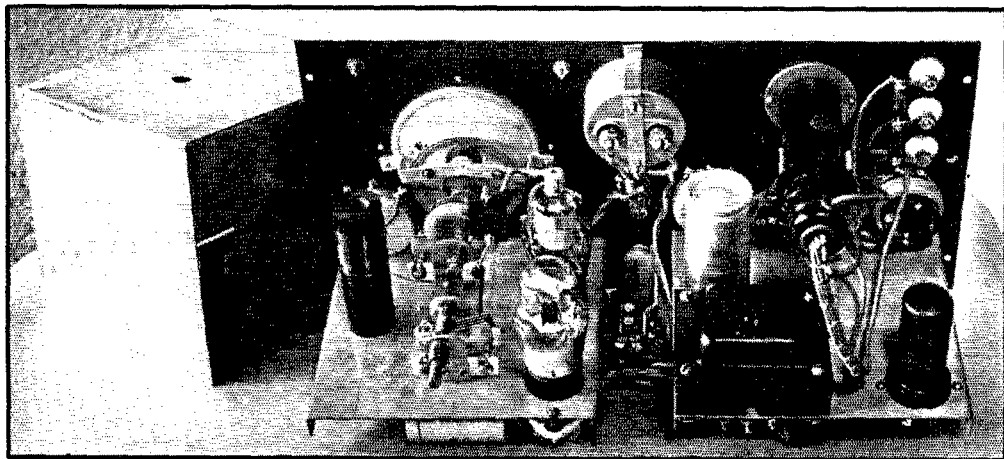

REAR VIEW OF THE CHASSIS WITH THE FREQMETER-MONITOR SHIELD REMOVED

The chassis decks are each $5\frac{3}{4}$ by $5\frac{1}{2}$ inches.

genuity as to the modulator in use. It has been the experience of the writer to visit a number of 'phone stations, some of which modulated according to instruments, others by attempting to listen to their own transmission and still others modulating entirely on the say-so of the operator at the other end of the QSO. At best a number of individual instruments were scattered about the shack or on the operating table.

The instrument shown in the photographs and diagrammed in Fig. 1 was designed for use

*Summit Radio Supply, Akron, Ohio.

can be constructed by the amateur for \$25.00 or under, less tubes.

Referring to the front view, the portion to the right of the milliammeter is the complete frequency-meter monitor with a 14:1 ratio vernier-reading dial, having a band spread on the 1715-ke. band from 4 to 87 divisions. To the left is the cathode-ray modulometer using the 1-inch 913 type tube with controls for focus and intensity, inputs being made available to the vertical and horizontal deflecting plates by means of the porcelain feed-through insulators. A highly fil-

tered power supply is self-contained, furnishing the necessary power to either the frequency meter or the modulator. The Triplett millimeter functions as a d.c. 0-10 ma. instrument when using the frequency meter, and as a high-sensitivity a.c. output meter when using the modulator.

Immediately below the pilot light is a four-pole double-throw jack switch which makes possible the unique switching arrangement of the power supply and the meter. To this switch are connected the high voltage of the power supply (both negative and positive floating above ground) the 0-1 milliammeter, a 0-10 ma. shunt permitting 10-ma. full scale deflection, and a copper-oxide rectifier for a.c. operation of the meter. The arrangement is such that with the switch centered, everything is off, although the power may be turned on by means of the 110-volt "on-off" switch on the focus control. Switching to the right connects the power supply to the frequency meter, *grounding the negative* and con-

necting the meter to function as a 0-10 milliammeter measuring the plate and screen current. In this position the full voltage is applied across a voltage divider, half of which is the 25,000-ohm potentiometer which applies and controls the voltage. In this manner the frequency-meter current is set, which assures accurate calibration. Switching to the left applies the full voltage to the cathode-ray circuit, *grounding the positive*, and connects the milliammeter to the copper-oxide rectifier through a suitable resistance network to function as a variable-range a.c. voltmeter or output meter.

A study of the complete circuit diagram, Fig. 1, shows no trick circuit or special equipment. The electron-coupled frequency meter, utilizing a 36 tube as oscillator and a 76 tube as monitor, is the conventional type but with the variable voltage control R_{12} . The meter shunt is wound to approximately 3.5 ohms and trimmed to deflect 10 ma. full scale. The exact value of resistance will depend on the meter used. The condensers C and

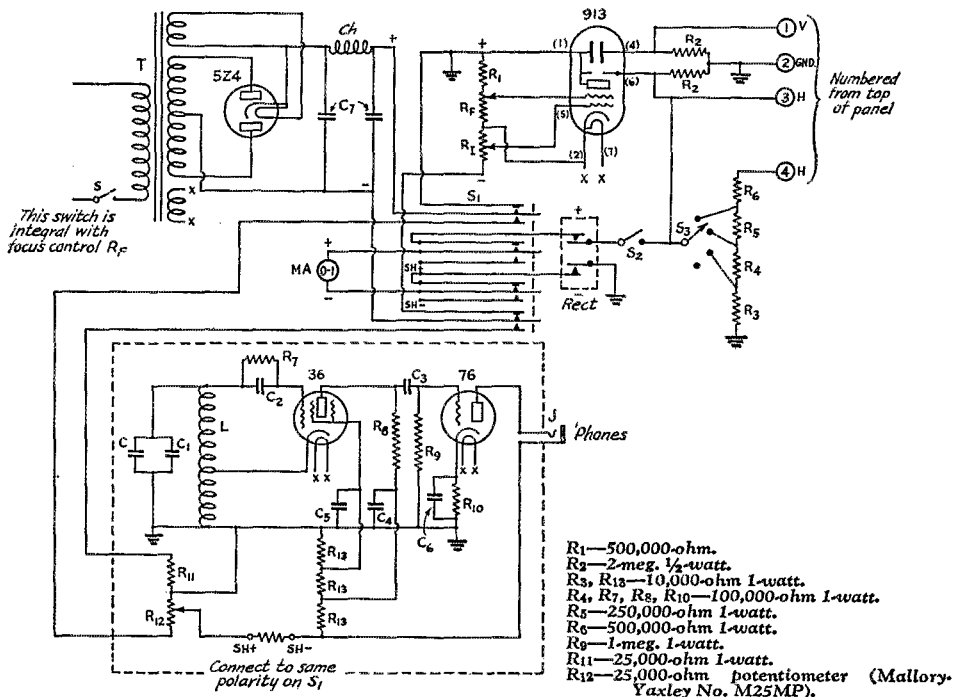

FIG. 1—THE COMPLETE CIRCUIT OF THE UNIT
L—79 turns No. 28 enameled on 1-inch form, tapped at 23 turns from ground end.

- C—35- μ fd. (Bud 897).
- C₁—50- μ fd. (Bud 989).
- C₂—100- μ fd. mica.
- C₃—400- μ fd. mica.
- C₄, C₅—0.02- μ fd.
- C₆—0.25- μ fd.
- C₇—Dual 8-8- μ fd. (Mallory RN-242).
- R—500,000-ohm 1-watt.
- R_F—500,000-ohm focus control potentiometer.
- R_I—500,000-ohm intensity control potentiometer.

- S—On-off switch (On R_F).
 - S₁—4 p.d.t. (Mallory-Yaxley No. 64).
 - S₂—S.p.s.t. toggle switch.
 - S₃—6-point selector switch (Mallory-Yaxley 1316L).
 - T—650-volts., c.t., 40 ma., 5-v. rect., 6.3-v. fil., (Freed No. 503).
 - Ch—30-henry midget filter choke.
 - M—0-1 milliammeter (Triplett model No. 223).
 - Rect.—Copper-oxide (Triplett C-4).
 - SH—Approx. 3.5 ohms for 33-ohm milliammeter (For 10 ma. full-scale deflection of meter used).
- Note: Terminals 1 and 2 are used for r.f. input from transmitter. Terminals 1 and 4 are used for input from modulator.

C_1 are mounted back-to-back, with C_1 acting as band-setting and adjusted through the rear of the shield can. This is the condenser seen with the slotted shaft in the rear view. This part of the instrument is adjusted, calibrated and used exactly as any other frequency-meter monitor. It is calibrated with a setting of 4 ma. and is adjusted to this point before use.

The cathode-ray modulometer section is the standard circuit recommended for the 913 tube with the addition of a fourth input post, which connects to the horizontal deflecting plate through resistance network for controlling the modulator input and the deflection of the output meter. When connecting up the complete instru-

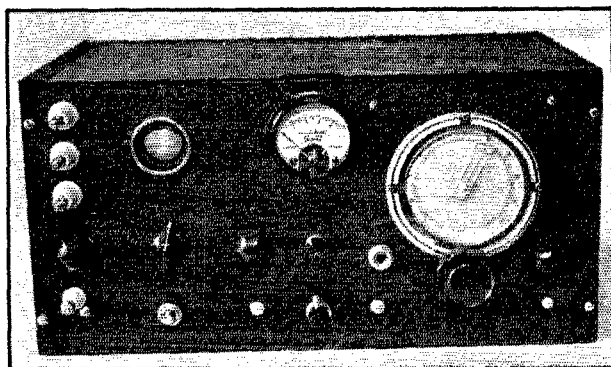

FRONT VIEW OF THE COMPLETE FREQMETER-MONITOR UNIT

The cabinet measures 14 by 7 by $7\frac{1}{2}$ inches.

ment, special attention should be paid to the wiring of the four-pole switch. Wire and follow through each circuit separately. The "on-off" switch is an integral part of the focus control potentiometer, R_F .

Use of this modulometer follows the standard practice recommended and discussed thoroughly in the A.R.R.L. *Handbook* and previous *QST* articles. The operation of the output meter when using the modulometer is an unusual feature which is very valuable in controlling over-modulation. With the trapezoidal pattern which indicates modulation of the transmission being checked, the output meter will deflect a definite amount for this percentage. Assume that 100 per cent modulation is being checked with a deflection of, say, 8 on the output meter. This deflection will, of course, vary with voice or music peaks. However, as long as the input to the speech amplifier is controlled so as not to exceed this output of 8, over-modulation will not occur. This is the method used in monitoring broadcast transmissions.

The use of this instrument for laboratory or test work is self-explanatory; but one condition must be observed. When using the cathode-ray tube as an independent oscilloscope, Terminals

1, 2 and 3 are used for vertical deflection, ground and horizontal deflection, respectively. Therefore, the toggle switch S_2 (shown immediately below the pointer knob) must be thrown to the "off" position, or damage to the rectifier and meter may result.

Atlantic Division Convention

Washington, D. C., June 24th and 25th

DON'T forget the Hotel Washington at Washington, D. C., will be the headquarters of the Atlantic Division Convention, June 24th and 25th. The program is complete and the following speakers have accepted the invitation to be present and address the convention: Paul Godley, a famed radio amateur who went to Scotland to copy amateur radio signals in 1921; Ralph Harmon (Westinghouse); John Reinartz, W1QP; Dr. J. H. Dellinger (Bureau of Standards), and Donald McLennon (University of Maryland). With such speakers on the program those attending will receive the benefit of the best there is in experimental radio. The principal speakers at the banquet are: Hon. Frank R. McNinch, Chairman, Federal Communications Commission; Major General Joseph O. Mauborgne, U. S. Army; Rear Admiral C. E. Courtney,

Director of Naval Communications and Doctor E. C. Woodruff, president, A.R.R.L.

Washington is the most interesting city in the world and the convention committee extends a cordial invitation to all radio amateurs to make the trip. Any further information may be obtained from G. E. Marshall, W3DAP, Secretary, 146 You St. N. E., Washington, D. C.

Strays

Upon reflection, it must take some mixing to make those "Simple Directive Alloys" of May *QST*, page 108. —W3HFE



What the League Is Doing

League Activities, Washington Notes, Board Actions—For Your Information

Cairo The following table shows the amateur allocations as finally adopted by the Cairo Conference, effective September 1, 1939:

Frequencies	General Allocation (if any was made)	Regional Allocation	
		European Region ¹	Other Regions
1715-2000		1715-1925: (a) Amateurs (b) Fixed (c) Maritime mobile 1925-2000: (a) Amateurs (b) Maritime mobile, A3 only	(a) Amateurs (b) Fixed (c) Mobile
3500-4000		3500-3635: (a) Amateurs (b) Fixed (c) Mobile 3635-3685: Non-open ² 3685-3950: (a) Amateurs (b) Fixed (c) Mobile 3950-4000: Aeronautical	(a) Amateurs (b) Fixed (c) Mobile
7000-7300	7000-7200: Amateurs 7200-7300: ³ (a) Amateurs (b) Broadcasting		
14-14.4 Mc.	Amateurs		
28-30	Amateurs— Experiments		
56-60		56-58.5: Television and Low-Power Stations ⁴ Norm.—The administrations may, if they consider it necessary, authorize amateurs to use the band 56-58.5. 58.5-60: Amateurs. Experiments. Low-Power Stations ⁴	Amateurs— Experiments
112-120		Low-Power Stations ⁴ Norm.—The administrations may, if they consider it necessary, authorize amateurs to use the band 112-120.	Regional ⁵

¹ The European Region extends to longitude 40° E. and southwards to latitude 30° N. except for the parts of the Arabian Peninsula lying within these limits. It thus includes African countries bordering on the Mediterranean.

² I.e., not open to public correspondence. In some countries may be state services, such as police. In others, will be military. By special arrangement, U.S.S.R. does not here follow the European column but rather the one for "other regions."

³ A footnote opposite 7200-7300 in the Cairo table reads: "This band can only be used for broadcasting in regions other than the American continent (including the territories and possessions of the countries of that continent)." The term American continent embraces both North and South America.

It will be seen that no changes are made in the frequencies allocated for use in the American continents. European amateurs suffered a minimum of loss in the face of tremendous pressure occasioned by the growing needs of aviation, the desire for more broadcasting frequencies, and the expansion of military facilities.

The complete story of Cairo will be told in the next issue of *QST*.

New Canadian Regs

Several changes made recently in the Canadian regulations are to be noted. Commencing July 1st, the "80-meter" Canadian 'phone sub-band will be 3800-4000 kc., the extra 50 kc. having been included to compensate for the loss of 3500-3550 kc. at the Habana Conference. Also, after July 1st, the 160-meter band will read 1750-2050 kc. (per the Habana agreement) with the 'phone assignment going from 1775-2050 kc.

A few minor changes in 'phone operation have been made, notably that it will be necessary for all 'phone stations to have a visual modulation meter as part of the station equipment. After April 1st it will be necessary to have crystal control or the equivalent when operating in the 28-Mc. band.

Glacier Park District Convention

(Northwestern Division)

Two Medicine Lake, Mont., July 16th and 17th

LAST year's first gathering at the foot of Mount Rockwell, Two Medicine Camp, in the heart of Glacier National Park, was so successful that a committee under the direction of Dr. J. Arthur Lamb, W7ABT, was appointed to plan for the 1938 affair. Hence let it be known that this committee, representing the Electric City Radio Club, Great Falls, Mont.; the Glacier City Radio Club, Kalispell, Mont.; The Butte Radio Club, Butte, Mont., and the Missoula Radio Club, Missoula, Mont., extend a cordial invitation to all hams and their families and the sections as represented by the clubs to attend

(Continued on page 90)

⁴ A footnote defines a low-power station as one of which the power is below 1 kw. Does not state whether input or output meant. Nothing is said about the type of station. This is deliberately vague, meant to cover everything, particularly military installations.

⁵ A footnote appears in the "other-regions" column opposite all allocations above 30 Mc. (except the 56-60 band) stating that a table in Appendix 4 indicates an allocation which shall serve as a guide for research and further experiments on the American continent. Appendix 4 then reproduces the figures thus tentatively adopted at Habana as an American guide between 30 and 300 Mc. These include exclusive amateur allocations throughout the Americas of 56-60, 112-118 and 224-230 Mc.

A New Type of Frequency-Checking Device

A Signal Generator Giving 10-Kc. Intervals Throughout the High-Frequency Spectrum

By George Grammer*

TO SAY that frequency measurement is an indispensable part of amateur radio is simply to repeat a truism, yet in common with many accepted practices our methods can stand re-examination to determine whether they meet our needs as effectively as they might. Fundamentally, we are interested in frequency measurement for two purposes: to locate the edges of the bands in which we work, and to provide a means for locating stations with whom we want to communicate. This is obvious enough, but occasionally we lose sight of the fact that while a high order of accuracy is required for the first, a much lower order will suffice for the second. Band edges are perfectly definite spots in the spectrum beyond which amateur signals are not supposed to go. Therefore too much care cannot be used in locating them precisely, especially if the transmitter frequency is to be set near the edge. On the other hand, an amateur transmitter may be set anywhere inside a band without regard to the exact frequency upon which it is operating. Aside from purely academic interest one may have in knowing his frequency precisely, measuring it to the degree of exactness desirable for band-edge measurements exceeds the practical necessities of the business of having it found quickly and easily by a receiving operator.

Considering this question still further, how much accuracy is necessary? We may assume at the start that a higher order of accuracy will be needed for c.w. reception than for 'phone, simply because a higher order of receiver selectivity can be used in normal operation. Probably the ideal would be to pre-set the receiver so closely that when the desired station came on no retuning would be needed to "peak" the signal. A more practicable standard, however, and one equally useful in operating, would be that the beat note should be within audibility when a reasonable degree of selectivity is used at the receiver—for instance, with a crystal filter in the broad posi-

tion. Under these circumstances, a variation of three or four kc. at the receiving end is permissible, providing the transmitter stability is great enough, but the long-time transmitter stability is seldom extremely high, even with crystal control. Crystals do change frequency with temperature and oscillator tuning, and the effects of these frequency shifts become greater as the output frequency increases.

Taking all factors into consideration, setting the receiver within a range of 5 to 10 kc. of the transmitter frequency is about as far as one needs to go; such a range readily can be "searched"

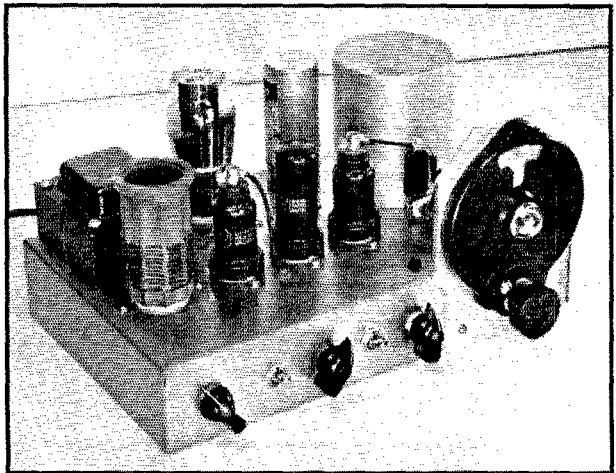

THIS UNIT WILL GENERATE SIGNALS FOR FREQUENCY CHECKING AT INTERVALS OF 10 KC. AT ANY POINT IN THE HIGH-FREQUENCY SPECTRUM

With continuous checking against a standard-frequency signal, the accuracy is limited only by the accuracy of the standard and the precision with which the oscillator can be adjusted to zero beat with it.

without much possibility of missing the desired station. And in most cases, particularly on the higher frequencies, such a range will have to be searched whether the receiver can be set more accurately or not.

It would seem, then, that a desirable form of frequency-checking device would be one which would indicate as accurately as possible the edges of the various bands and would in addition also indicate with equal accuracy a series of spot fre-

* Assistant Technical Editor, QST.

quencies about 10 kc. apart right through each band. With any two adjacent 10-kc. points accurately located, a signal is quite neatly "trapped" and can be picked out readily. Such a device, generating spot signals, is inherently capable of a much higher order of accuracy than the conventional frequency meter with its variable range, simply because it can be checked continuously against one of the many available signals of known high accuracy. For the same

circuit is concerned; plug-in coils are used here in order to provide whatever tuning range may be deemed desirable. The grid circuit is not tuned, but simply coupled through a small capacity to the plate of the oscillator.

It might be well to mention here that a 100-kc. crystal oscillator readily could replace the electron-coupled circuit shown. With temperature control or a low-drift crystal such as the Billey SOC-100 unit, a highly-satisfactory secondary frequency standard can be constructed.

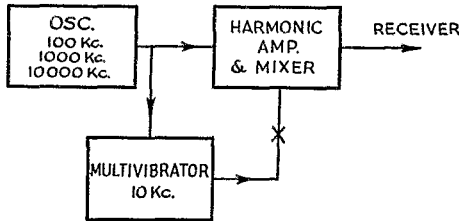

FIG. 1.—THE BASIC ARRANGEMENT OF THE FREQUENCY-CHECKING UNIT

reason, no calibration is needed once the preliminary adjustments have been made.

The construction of such a frequency-checking device is relatively simple, and does not require very many more parts than does the ordinary frequency-meter. The unit pictured herewith may look somewhat elaborate, but if so it is only because it has a built-in power supply.

CIRCUIT ARRANGEMENT

Essentially the unit consists of a 100-kc. electron-coupled oscillator, the uses of which are well known,¹ followed by a harmonic amplifier employing a 6L7 tube. In itself the harmonic amplifier is a worth-while addition to the oscillator, since harmonics get quite weak in the higher-frequency regions, but the use of the mixer tube opens further possibilities. In this case, the output of a 10-kc. multivibrator, locked on frequency by the 100-kc. oscillator, is fed to the injection grid of the 6L7 and thereby modulates the output of the tube. Since the multivibrator is rich in harmonics, each 100-kc. signal is modulated at 10 kc. and its harmonics, so that in effect the output of the harmonic amplifier consists of a series of carriers 10 kc. apart, amplified at that part of the spectrum to which the 6L7 plate circuit happens to be tuned. Fig. 1 indicates the general arrangement. The oscillator tuned circuit is plug-in so that 1000- and 10,000-kc. coils can be inserted for purposes to be described later.

The complete circuit diagram is given in Fig. 2. The four sections comprising the unit are clearly marked to avoid confusion. The oscillator will be recognized as practically identical with the one previously described.¹ The 6L7 section is the conventional r.f. amplifier insofar as its plate

¹ D. H. Mix, "A 100-kc. E. C. Oscillator for Frequency Checking," *QST*, May, 1937.

THE MULTIVIBRATOR

The only part of the circuit likely to be unfamiliar to the average amateur is the multivibrator. This consists of two triodes—a 6N7 provides both—with grids and plates cross-connected to form a resistance-capacity oscillator. The oscillation frequency depends primarily on the values of resistance and capacity used, and is readily "locked" by another oscillator operating at a frequency several times that of the multivibrator itself. In this case the resistance-capacity values are chosen so that the fundamental frequency is about 10 kilocycles; the values are not particularly critical insofar as obtaining operation is concerned, but are fairly critical if adjustment and manual control are to be easy. It is particularly important, for instance, that low values of resistance be used at R_{13} and R_{14} , in the plate circuits; if high values are used, selection of the proper operating frequency requires a great deal of care. The frequency control is R_{11} , a variable resistor in series with R_{10} in the grid circuit of one of the tube sections. Although a single 35,000-ohm variable might be used in place of the fixed and variable units indicated, the arrangement shown gives a "band-spreading" effect resulting in greater ease of control. With the constants given, the frequency range is such that with the oscillator on 100 kc., the multivibrator can be made to lock on its 8th to 12th harmonics, inclusive, bringing the 10th (10 kc.) at about mid-scale on R_{11} . The 300-ohm resistor in the cathode circuit is used to provide some grid bias so that the 6N7 plate current is not excessive. It can also be used to provide coupling for control voltage from the oscillator through a small condenser, C_{15} , as shown by the dashed lines in the diagram. In actual practice this coupling was not found to be necessary, since the multivibrator picks up sufficient control voltage simply because of its proximity to the oscillator.

The switch Sw_1 is used to cut the multivibrator out when only 100-kc. points are wanted. The switching method shown was used so that the plate current of the 6N7 would be substantially the same whether oscillating or not, since its plate current constitutes the major load on the plate supply. This avoids any considerable change in plate voltage and hence reduces the tendency of the oscillator frequency to change when the

of which is soldered to the rotor-plate connection. C_1 is mounted directly on the chassis, the dial being fitted accordingly. Solid construction throughout to avoid "bubbling" in the oscillator is highly desirable. The output coil, L_2 , is out in the open since shielding is not required and would complicate coil changing.

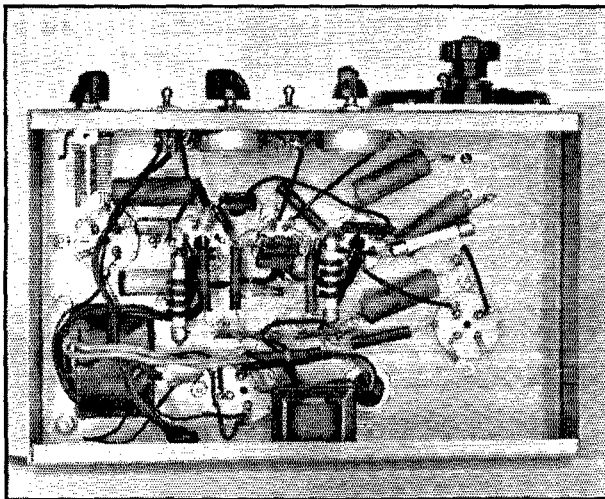

INSIDE THE CHASSIS

A power supply is included for convenience. The parts used are mostly inexpensive condensers, resistors and coil forms.

In the front view, the controls along the edge of the chassis from left to right are C_2 , the output tuning condenser, Sw_2 , the a.c. line switch; R_6 , the output volume control; Sw_1 , multivibrator on-off switch; R_{11} , the multivibrator frequency control; and the large dial, C_1 , the oscillator tuning control. The slow-speed dial (a National Type B) permits fine adjustment of the oscillator frequency.

The bottom view shows the below-chassis layout of components. Grounds are made directly to the most convenient point on the chassis. Aside from mounting parts so that the chances of vibration are minimized and unduly long leads are avoided in the r.f. circuits, no special rules have to be followed. The plate circuit of the amplifier is parallel fed simply so that C_2 need not be insulated from the chassis.

The padding condenser, C_3 , across the oscillator coil is one of the new low-drift type using mica dielectric with plated silver electrodes. The stability of these condensers is comparable to that of air-dielectric types with changes in temperature and humidity, and in this and similar applications they are to be preferred to the ordinary molded mica units. The particular type used was a Sickles "Silver-Cap"; similar units are being made by other manufacturers.

Winding data are given for L_2 covering practi-

cally all the frequencies in which amateurs are likely to be interested, including the broadcast band.

PRELIMINARY ADJUSTMENT

Once such a unit is built the first step in the adjusting process is that of setting the oscillator to 100 kc., which may be done either with or without the amplifier functioning. A broadcast receiver is a necessary part of this process. Tune in a station operating on a frequency which is some harmonic of 100 kc., preferably at the low-frequency end of the band (600, 700, 800 kc., etc.) and bring a wire from the grid of the amplifier near the receiving antenna. Adjust C_1 to give zero beat with the incoming signal, then tune the receiver to another even-hundred channel where a b.c. station can be heard and see if the appropriate oscillator harmonic is reasonably close to zero beat (within 50 cycles or so). If so, the oscillator is set correctly, and the dial reading should be noted. The correct setting probably will be near maximum capacity on C_1 .² Sw_1 should be closed during this adjustment.

Now plug in a coil at L_2 and couple it through a link or some other convenient means to the input of an amateur-band receiver, leaving off the regular antenna connections to avoid troubles with incoming signals. The 3.5-Mc. range on the receiver is a good one for this step. Tune in a harmonic of the oscillator and adjust C_2 for maximum signal strength. Probably the receiver will be overloaded, so the coupling may be reduced or the output cut down by means of R_6 . A definite increase in strength at one setting of C_2 indicates that the amplifier is functioning properly. Pick up two or three more 100-ke. points through the band and note their settings on the receiver dial; if the receiver calibration is known fairly well this will serve as an additional check on the initial setting of the oscillator, since there should be a signal at each edge of the band.

ADJUSTING THE MULTIVIBRATOR

The third step is that of adjusting the multivibrator. Open Sw_1 , putting the multivibrator in action. A whole series of signals should appear across the band. With the receiver dial settings

(Continued on page 98)

² The National choke plus the 1100- μ fd. fixed and 100- μ fd. variable condensers should resonate without difficulty to 100 kc. providing the fixed capacity is close to rating. Should the minimum frequency turn out to be too high, an additional 100- μ fd. fixed condenser may be shunted across the circuit; if too low, turns may be taken off the choke pie nearest the grid.

H A M D O M



IT TAKES something more than a world-rocking event to shock an ardent DX-Contestant into sensibility of external events. That something was provided during the fading hours of the 1938 affray.

The thud of marching feet resounded throughout the world in middle March as German Nazis entered Austria for the consummation of German-Austrian "Anschluss." But it was no more than a faint murmur of conversational QRM in the background of whispering, whistling DX, as XYL's and OW's intruded bits of world news along with coffee and sandwiches. No more, that is, until the coincidental significance of the disintegration of Austria as an entity and the continued pouring out of crisp, clean-cut operating labeled with the call OE3AH became apparent.

For a DX'er scarcely breathes who does not know that OE3AH is—was—the station of His Royal Highness, the Archduke Anton of Hapsburg, first cousin of Archduke Otto, pretender to the Hapsburg throne, and husband of the Princess Ileana of Roumania.

Surely there was a story here. While the nation crumbled about his ears, while the Austrian Nazis—long enemies of the ancient house of

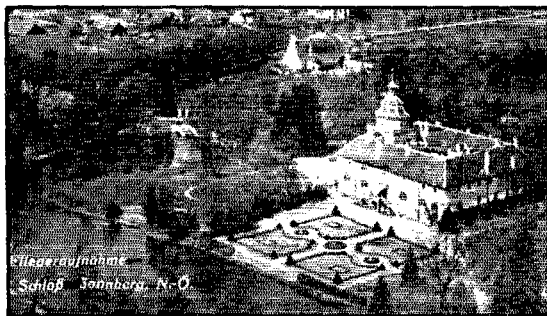

SCHLOSS SONNBERG, HOME OF ANTON HAPSBURG, ARCHDUKE OF AUSTRIA, AND QTH OF OE3AH

Hapsburg and the monarchist movement—scrambled into power, Anton calmly added multipliers to an already weighty contest score!

That was about all that was known, at first—that OE3AH had worked right on through to almost the end of the contest, apparently oblivious to the historic events occurring around him. Then rumors and fragmentary reports began to seep through. A week after the contest ended a London Exchange Telegraph dispatch from Budapest reported that he had been im-

prisoned in an Austrian Nazi concentration camp.

"The arrest and imprisonment of Archduke Anton followed discovery of a secret radio station in his Sonnberg Castle home near Hollabrunn," according to the INS version of the dispatch. Another Budapest dispatch reported that it was rumored in Vienna that Anton had been taken "into protective custody in his own interest."

If true, these reports meant that, other than the Archduke Josef Ferdinand, Anton was the only member of the Hapsburg house molested by the Nazi régime. Even his wife, the Princess Ileana, was reported to have been allowed to leave the country for an exile's refuge at Merano, Italy.

They meant further that it was his amateur operation—his insistence on participation in the DX Contest until the closing minute—that cost his arrest. Conceive a member of a royal house sticking to his key until his very safety was threatened just to add a few more entries to his log!

What may have precipitated the actual arrest is not clear. Perhaps constabulary forces invaded the Schloss Sonnberg on a routine check-up—only to find this "secret radio station" in full operation. Imagine their attitude toward an explanation of an international amateur DX contest! Or perhaps, as has been hinted, Austria's ruling Nazis seized upon Anton's long-pursued hobby of amateur experimentation as an excuse to strike at the house of Hapsburg.

Whatever the underlying causes, it was but a month or so before further reports began to trickle through—rumors that the provisional arrest had been terminated, that Anton was now allowed the freedom of his own estate. Finally, there came the first word from OE3AH himself—a carbon copy of his original contest log, constituting his report. This was dated April 5th; it was received two weeks later. It is fascinating document, and by no means the least amazing thing is that—with the state of Austria dissolved as a separate entity—the bold signature to the sworn statement reads: Anton Hapsburg, Archduke of Austria!

The Archduke Anton has been interested in radio for a considerable period of time. In this interest he was joined by his brother, Archduke Franz Josef, who was more or less of a silent partner in the activities of OE3AH. For the past four or five years they have been distinguished in

international ham circles for a signal far superior to the average European standard and a record of performance approached by few. Indeed, during Franz Josef's visit to the United States during December and early January he kept in touch with his home by schedule through W2DIJ—on 14 Mc. at noon each day.

It was in international DX contests that OE3AH particularly shone. The log submitted for the 1937 battle, wherein 71,552 points were scored, lingers in our memories as the most unique supplied by any station. Carefully hand-lettered in elaborate tabulation, with illuminated initials and headings, it merited a special award of its own.

This year's log was quite the opposite. Although neatly written on specially-printed contest log paper, it was obviously the original log. OE3AH excused himself for this; he said he had no time to make a copy. An intriguing thing about the log is that it shows an even 600 contacts—the last being made at 2459 M.E.Z., giving him an even 90 hours of operation. With a multiplier of 43, the total score was 76,239.

Mention of OE3AH and DX brings to mind the recent feat of which he was most proud—the setting up of a DX record on 28-Mc. 'phone from an airplane in flight, last December. The circumstances are these:

On December 12th Anton set out from Vienna for Budapest in his ship. With him were OE1FH, OE1EZ and one other—and a 28-Mc. transmitter using a plate-modulated RK-25 in the final, with a 2-tube superregenerated in the same cabinet. A genmotor supplied the power, and two 33-foot antennas ran outside the plane.

The original idea was to maintain contact with a 10-meter base station in Vienna for as much of the flight as possible. OE3AH did the operating. Every 15 minutes he had a sked with his home station, where OE3WB was at the key, on 7 Mc. (using the regular two-way plane equipment). In addition he combed the 28-Mc. band—a full program, on top of piloting the ship!



OE-DEA

The airplane from which Archduke Anton made his in-flight 28-Mc. DX record. It is a six-seater cabin job, equipped with two 260-h.p. Gypsy Mayor engines, giving a top speed of 130 m.p.h.



OE3AH

The exciter, above the HRO, contains a 59 Tri-tet or e.c.o. RK-25 doubler and RK-20 output; all coils are switched. This unit is also used as portable, and can be suppressor-modulated. The final, just right of the lamp, uses two RK-38's, their 2200-volt supply being under the table. A current-fed Hertz 384 feet long runs between a 100-foot wooden mast and the castle roof. At the right is p.p. 203-A transmitter which was in use for several years on 7 and 3.5 Mc.

When the 10-meter band was found unexpectedly alive with signals, with especially good conditions for W, the idea of a little DX was born. One of the first stations heard was VU2CQ, calling DX on 'phone. Just as a gesture he was given a short call. The unexpected happened and he came back. A solid 15-minute QSO resulted, with QSA5 S7 both ways. A little later W2BHY was contacted briefly, although no extended QSO resulted. By then flying conditions forced a quick return.

Even so, the log showed DX covering several thousand miles in both directions—probably a record for the conditions involved. The time, by the way, was around 1330 G.T.

We've said it so many times that the thought is becoming hackneyed. But we can't refrain from repeating that ham radio must be a pretty swell hobby, when a person like Archduke Anton, with all the world's pursuits to choose from, should go for it in as big a way as he—and dozens of other famous personages—have done.

Strays

Correction

In the circuit diagram of the 5-, 10- and 20-meter converter on page 28 of May *QST*, R_5 should be connected to the grid side of C_{13} , rather than the coil side.

75-Meter 'Phone Goes Hunting in the Maine Woods

By P. L. Spencer,* WIGBE

THE particular spot our party prefers for hunting deer in the state of Maine is about thirty miles from a telephone, nine miles of which are across Nicasious Lake, which is not navigable in a canoe when strong winds, which often occur in November, are blowing. There are two reasons for our party's preference for this spot; the first being abundance of game, and the second that it is not frequented by many hunters of the type who are expert shots at red caps, red jackets and bushes.

When planning the trip this year, Mr. Wood, one of the party, suggested that we carry a portable transmitter and receiver that could be used should any emergency arise. The writer, being aware of the fact that we should have to pack the equipment some considerable distance over a very rough terrain, planned a transmitter of the lightest possible weight, to be entirely battery operated. These plans, plus the suggestions of some ham friends, resulted in a two-tube transmitter consisting of a single R.K-25 crystal oscillator, suppressor-grid modulated by a receiving-type 89 tube with a telephone-handset type microphone. For batteries we used Eveready No. 1562 Hotshots on the filaments, and No. 762's for the "B" supply and suppressor bias. We had 405 plate volts, 22½ suppressor volts and 200

* 85 Adena Road, Newton, Mass.

screen-grid volts. Our total "B" input was 10 ma. at 405 volts or 4 watts. We took 120 feet of No. 20 enamelled wire and two ten-cent store insulators for the antenna. The receiver was a Philco two-volt broadcast set covering the short-wave bands.

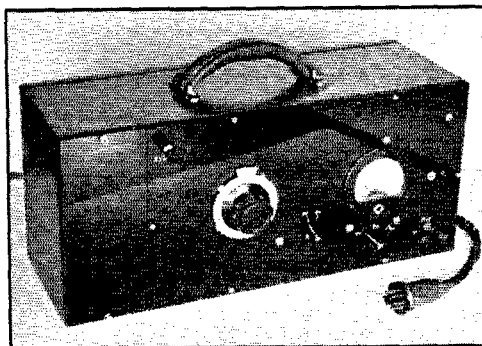

THE PORTABLE 75-METER 'PHONE IN ITS CARRYING CASE

The antenna connects to the binding post near the top of the panel.

This receiver was selected because the previous year we had promised a radio to our host, Mr. Carl Makinney, who is a trapper and whose camp we use on our trips. Mr. Makinney spends the long winter months alone, and this receiver should make the evenings much less monotonous. After completion of the transmitter, we gave it a trial at W1CAV's shack and worked a W3 and a W1 with 4 watts input, or approximately 1.4 watts carrier. We were very much elated by its performance.

We arrived at camp with all our gear Saturday, October 30th. After setting up the receiver, which gave no trouble, the antenna for the transmitter was hooked to a tree far enough away to use up the 120 feet of antenna wire. The transmitter was then connected to the batteries, connections checked and we were ready to test. Before leaving we had arranged schedules with W1HSV. Jack Ivers of Somerville, who promised to have reports

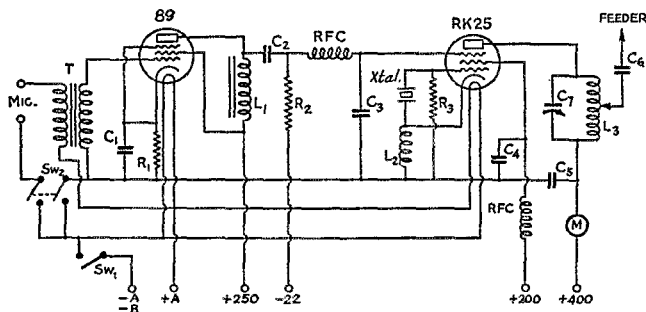
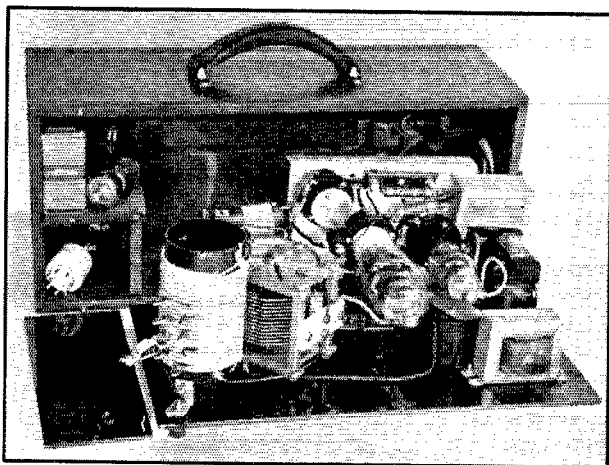

FIG. 1—CIRCUIT DIAGRAM OF THE PORTABLE 75-METER 'PHONE

- C₁—8 μ f.
- C₂—4 μ f., 400-volt.
- C₃, C₄, C₅—0.002- μ f. mica.
- C₆—100- μ f. mica.
- C₇—350- μ f. variable.
- L₁—30-henry choke.
- L₂—30 turns No. 20 d.c.c. on 1-inch form.
- L₃—24 turns No. 14 d.c.c. on 3-inch form, tapped every 2 turns from antenna end to 16th turn.
- RFC—2.5-mh. r.f. choke.
- SW₁—S.p.s.t. midget switch (on-off).
- SW₂—D.p.s.t. midget switch (microphone and plate supply).
- T—Single-button microphone transformer.
- R₁—1000 ohms, 1 watt.
- R₂—10,000 ohms, 1 watt.
- R₃—50,000 ohms, 1 watt.



AN INSIDE GLIMPSE
Spare tubes are carried in the compartments at the left.

from our folks at home. As these schedules were for 6:00 A.M. we had to try a CQ. The first CQ resulted in our contacting W1CZ of Houlton, Maine, and subsequently we worked W1ACW of Presque Isle, Maine, and VE1AR of Bridgewater, N. S. The real test, however, was to come—contacting W1HSV on schedule at 6:00 A.M. the next morning.

We were up at 5:00 A.M. waiting for the schedule. Promptly at 6:00, W1HSV called W1GBE portable at Nicasious Lake, Maine. We could hardly wait for him to finish the call. When he stood by, we gave him a short call and he came right back and reported us QSA5 S6 to 7. Hurray! Were we delighted! We carried out our QSO with very little difficulty. All succeeding schedules were 100 per cent at both ends and for a 1.5-watt carrier the 375 miles were spanned to perfection. Monday we contacted W1BUZ of Oldtown, Maine, who agreed to cover our frequency at frequent intervals in case of an emergency. We were very grateful to W1BUZ, W1CZ, W1ACW for their true ham spirit and coöperation. We reported our hunting successes or failures every day to W1HSV, who informed our wives. The second day he reported they were all getting our reports direct on their broadcast receivers, so quite a few comments on our meals and experiences were injected for their benefit during the contacts with W1HSV. We had several visitors at the camp—natives who were either guides or hunters—and they were greatly amazed at our ability to contact the outside with the outfit, since it was impressive because of its small size and simplicity.

The hunting trip also was successful, each of us getting the limit. The writer went out early Monday, November 1st, the opening day, had a standing shot at two deer and missed them by a

mile. Buck fever had me in its grip. In the five hunting days we were there, I personally saw twenty-four deer; had another standing shot Wednesday and didn't miss, but had a long job of trailing the critter until I finally got him near Sabio Lake. Did we modulate that transmitter the next A.M.! Everybody in the world should have known that I got that deer! Mr. Wood and Mr. Schierbaum, the other members of the party, were having equal success, so our hunting and radioing from the Maine woods was over. If anyone can tell me how to have a more satisfying week than we had with hunting, portable radio, evenings with the broadcast receiver and relating our experiences of the day, then consider me as willing to try his plan!

Strays

A Ham Riddle*

The (W1JM) and (W1HCO) of (W1IWU) (W1ENS) (W1DKF) a (W1KT) for (W1QG) in a (W1BD). The (W1BLS) (W1JKV) (W1GXX) met the (W1BVR) (W1LW) with a (W1BFU) (W1BGD)

A (W1JEF) (W1JTH) (W1DLM) threw a (W1HPH) in the (W1BGD). The (W1HCO) (W1COO) to sit. A (W1IAV) (W1GOK) did (W1FPV) (W1JHA). "(W1DJR)!!! It (W1FJE). My (W1CUX) my (W1DFY) (W1FJE) (W1FWK)!!" "(W1AIX)" said (W1JM) (W1GUG), as he (W1AWX) over (W1GSY). He (W1BJP) the (W1HPN) out. "(W1DJR)!!! (W1CUX), get (W1GOS) to (W1BST) (W1FWK)" said the (W1HCO).

Once (W1AIA) she took a (W1CVD) the (W1BGD) and said, "(W1DKU) (W1IQK)?" "Yes (W1AGL)" said (W1GUG).

So that is the (W1ACD) of how the (W1BLS) (W1HPH) up against the (W1CAJ) (W1HCO). (W1IJM).

* Substitute the family name of licensee for call letters.

—W1IIE

W7FRM
IS A BRAKEMAN
ON THE
UNION PACIFIC

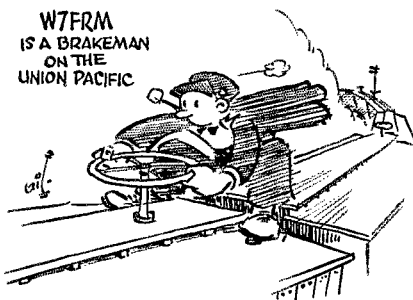

W9RSO Wins 1937 H.P.M. Award

THE winner of the Maxim Memorial Award for 1937 was announced in April to be Oscar L. Short, W9RSO. This award, it will be recalled, was created about a year ago by Mrs. John G. Lee and Mr. Hiram Hamilton Maxim, the daughter and son of our late president and co-founder of A.R.R.L., Hiram Percy Maxim. Consisting of a bronze replica of the Wouff Hong and the sum of one hundred dollars in cash, it is awarded annually to the outstanding young American amateur under 21 years of age. The first winner, for 1936, was Victor H. Clark, W6KFC.

This year's winner, chosen from a list of candidates entered by various S.C.M.'s, is again an outstanding example of an all-around amateur. His success as an amateur is based on intensive, intelligent application; no factory-made receivers or transmitters, no large reservoir of parts and equipment. Instead, each piece of apparatus is a considered entity, inexpensive and simple but the product of long experiment and practice—and therefore a performer.

Such equipment, used to maximum advantage, usually turns in a better record than elaborate gear haphazardly handled. This is true with W9RSO. . . . But we seem to be getting the conclusion ahead of the story, and that won't do. Here, briefly, is his career:

Oscar L. Short was born in Topeka, Kansas, on March 24, 1918. This city was his home until the death of his father, which occurred in 1924. The father was superintendent of overhead and underground cable construction for the state at the time of his death; he had been with Bell Telephone for 26 years when he died at the age of 46.

It was from his father that the youngster received his first instruction in elementary electricity—truly a captivating subject for a lad of six.

Following the father's death the family moved to Kansas City. During the succeeding few years Oscar's education was very irregular, as the family moved several times and school work was thereby interrupted. After some years Mrs. Short and her son finally reached a haven on the farm of an aunt and uncle, six miles from Jasper, Mo. It was there that Mrs. Short died, when Oscar was 13. Since that time he has made his home with these relatives.

His first contact with amateur radio came when he visited W9IQM, in Jasper. Forrest Weber, the operator, took a friendly interest in the eager lad. First he built up a code practice oscillator, and later a beginner's receiver. This receiver had but one Type 30 tube, but so perfect were conditions on the farm that he could hear a wide variety of signals. He heard enough to fire him with enthusiasm for amateur radio and a burning desire to possess a transmitter of his own.

This was difficult on the farm, with no a.c. power available, but about a year later the family moved to Webb City, Mo. This was a great break for Oscar. In the intervening year he had been diligently studying the *Handbook* and all the radio magazines he could find, and not long after arriving in Webb City he located another would-be ham, Kenneth Thomas.

The pair started working together on the code. After a short period of daily practice (two hours a day!) they reached a speed of 17 w.p.m. "We were afraid to try the code examination until we had a good safety margin over 10 w.p.m., to allow for excitement of the first radio examination," he writes. "I believe many fellows overlook this fact when they study for their code examination." The value of this policy was demonstrated when they passed their examinations with ease and in a short while were the proud possessors of two shiny new tickets—W9RSO and W9RTK. This occurred in 1934.

W9RSO's first transmitter was a small t.p.t.g. affair, but it was very quickly displaced by a Type 59 crystal oscillator. This rig lasted for several months. With it he worked both coasts regularly on 40 meters. About this time a new receiver was built, using a 58 r.f. stage, 57 detector and 56 audio. The same type of receiver—progressing through numerous stages of constructional refinement—has been in use ever since. A superhet would be fine, yes—but until the facilities for one become available it is surprising

(Continued on page 104)



OSCAR L. SHORT,
W9RSO

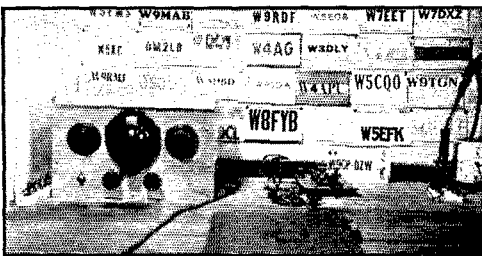

THE RECEIVING POSITION AT W9RSO
The W cards have since been replaced with DX QSLs!

The Pentagrid Tube as a Combined Second Detector and Beat-Frequency Oscillator

A Fundamental Limitation and Its Remedy

By G. C. F. Whitaker*

At various times designs for short-wave superhets have appeared¹ in which the functions of combined second detector and beat-frequency oscillator have been taken by one of the special multi-electrode frequency-changer tubes, usually a pentagrid. The circuit arrangements and constants have been conventional

with the exception of the cathode-bias resistor, which is increased to a value of several thousand ohms with the idea of obtaining plate detection.

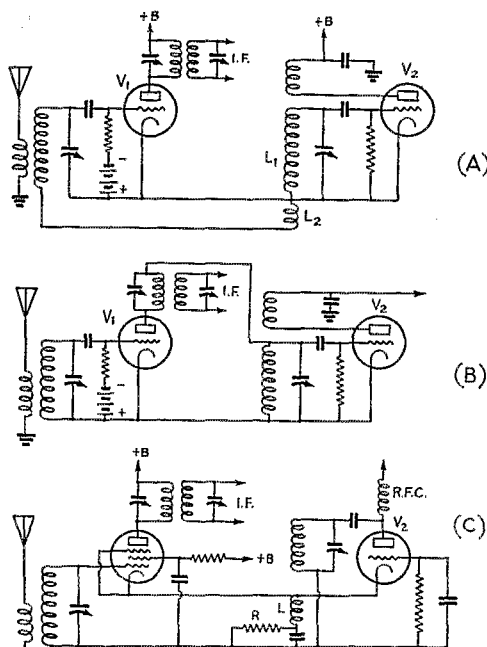

FIG. 1—FREQUENCY CONVERTER CIRCUITS OF THE RECTIFYING TYPE

A—The classical frequency changer; V_1 operates as a plate detector and V_2 as oscillator. Coupling is by mutual inductance L_1 - L_2 . B—The old "Ultradyn" circuit; V_1 has no "B" supply and operates virtually as an r.f. amplifier. The oscillator, V_2 , is directly connected across plate and cathode of V_1 , where rectification of oscillator voltage occurs by diode action. C—A modern type of frequency changer with cathode injection. V_1 is a sharp cut-off pentode biased to act as a plate detector. V_2 is any type of oscillator with cathode connected to that of V_1 , with a common impedance (in this case one coil of the oscillator circuit).

* C/o The Kailan Mining Administration, Chinwangtao, North China.

¹ Allen, "New Pentagrid Tubes in the Amateur Band Superhet," *QST*, August, 1933.

DeSoto and Goodman, "A Unit Style Portable Station," *QST*, August, 1937.

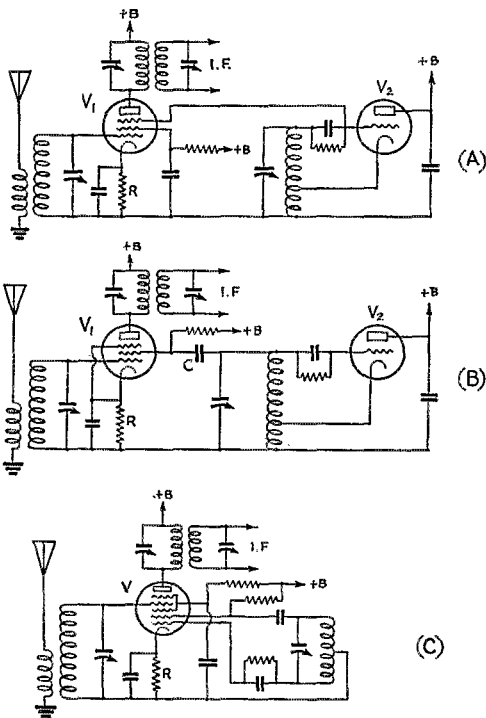

FIG. 2—"ELECTRON-COUPLED" FREQUENCY-CHANGING CIRCUITS

A—Suppressor-grid injection. V_1 is a variable- μ pentode biased for normal r.f. amplifier operation. V_2 is any form of oscillator. Suppressor grid of V_1 is directly connected to the control grid of V_2 , deriving requisite negative bias from rectified grid current. B—Screen-grid injection. V_1 and V_2 are as in (A). The d.c. screen-grid voltage should be below optimum for maximum signal-frequency amplification. The screen is connected to the oscillator circuit through isolating condenser C. C—Pentagrid frequency changer. Control grid is biased as in (A) and (B). R.f. voltage on oscillator-section grid varies the potential of the virtual cathode formed between Nos. 3 and 4 grids and so modulates the electron stream.

Practical experience with a receiver of this type invariably calls forth the same comment. The receiver gives excellent results on c.w., but the moment that the beat-frequency oscillator is switched off to receive a modulated transmission a marked drop in sensitivity occurs. The reason

for this does not seem to be generally appreciated and, since it is avoidable, is worth looking into more closely.

To do so it is necessary to consider the mechanics of frequency changing by means of beats, for which purpose this type of tube was expressly designed. The object of a frequency-converting set up of this type is, of course, the mixing of the two voltages of differing frequency and the extraction of a third frequency (usually the difference frequency) in the form of output. The types of heterodyne frequency changers in common use fall into two main classifications which differ quite considerably in their functioning, though outwardly they appear to be much the same.

The first group may be termed the "rectifying" type, since a fundamental requirement of this type of frequency changer is that one or both of the voltage beating together must be rectified before any beat frequency can be obtained.

This was the type of frequency changer used by Armstrong in America and Levy in France when originally developing the superheterodyne receiver. It persisted in a refined form up to the time of the development of the second group of frequency changers. Generally speaking, the practical layout of an arrangement of this type provides for rectification of the combined incoming signal and oscillator voltage.

In this group fall most of the two-tube frequency changers where oscillator coupling is made to the grid or cathode of the first detector. Typical examples are shown in Fig. 1. In its final and most refined form the layout consisted of an efficient sharp cut-off pentode, biased to give plate rectification with an oscillator coupled in some way into the grid or (in Europe) plate circuits.

It was from this type of frequency changer that the idea of rectification as an essential to frequency changing took root and which gave rise to the term "first detector" for the rectifying member of the partnership. Properly adjusted it can be very effective arrangement particularly where only a limited wave band has to be covered.

With the advent of a.v.c. and with the increasing power of transmitters on the broadcast bands, however, various difficulties were experienced with it and led to the development of the second group of frequency changers.

The second type of frequency changer operates by virtue of tube design and demands that the signal-grid-to-plate conductance shall be variable by voltages applied to some other electrode in the tube.

In the practical layout, the signal grid is operated with just sufficient fixed bias to avoid the signal's running it into grid current, and the

oscillator voltage is applied to the appropriate control electrode. The group includes all the specially developed frequency-converter tubes (with the exception of the 6F7, which falls into the first group) also the two-tube arrangements where an oscillator is coupled to the suppressor or screen grid of a variable-mu pentode with normal a.v.c. bias on its control grid. Typical examples are shown in Fig. 2. In the pentagrids the oscillator is of course built into the tube and

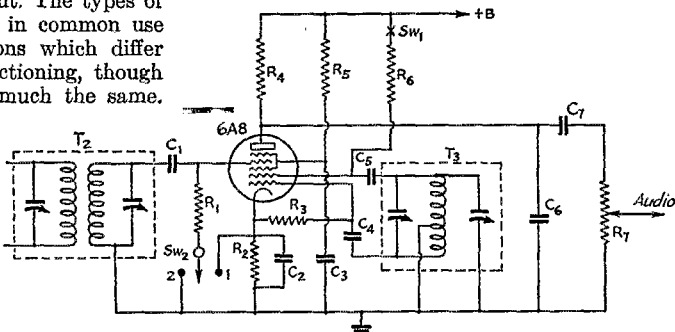

FIG. 3—MODIFIED CIRCUIT FOR USE OF PENTAGRID TUBE AS SECOND DETECTOR

- C₁—100-300- μ fd. mica condenser.
 - C₂—5- μ fd. electrolytic condenser.
 - C₃—0.05- μ fd., 200-volt paper condenser.
 - C₄—100- μ fd. mica condenser.
 - C₅—0.001- μ fd. mica condenser.
 - C₆—250- μ fd. mica condenser.
 - C₇—0.005- μ fd., 400-volt paper condenser.
 - R₁—500,000-ohm, $\frac{1}{2}$ -watt.
 - R₂—300-1000-ohm, $\frac{1}{2}$ -watt (see text).
 - R₃—50,000-ohm, $\frac{1}{2}$ -watt.
 - R₄—0.5-megohm, $\frac{1}{2}$ -watt.
 - R₅—3-megohm, $\frac{1}{2}$ -watt.
 - R₆—100,000-ohm, $\frac{1}{2}$ -watt.
 - R₇—1-megohm potentiometer.
 - T₂—1600-kc. i.f. transformer.
 - T₃—800-kc. b.f.o.
 - Sw₁—S.p. b.f.o. "on-off" switch.
 - Sw₂—S.p. two-way switch for change-over of detector operation.
- Position 1: Grid leak detector for reception of unmodulated signals with b.f.o. "off."
 Position 2: Standard "frequency changer" operation for heterodyne reception with b.f.o. "on."

no external coupling arrangements are called for.

We now come to the basic and fundamental difference between the two groups. The second type of frequency changer in no way demands rectification in the usual sense as an essential to the process of frequency changing. On the contrary, for reasons connected with the avoidance of spurious responses and cross modulation, every effort is made by the designers to ensure that rectification effects in the signal grid-plate circuit are kept to the absolute minimum.

For this reason then, and to facilitate the application of a.v.c. voltages to the signal grid, it is given the long tailing characteristic typical of the variable-mu tube, and is not well suited for plate rectification.

Considering the combined second detector-beat frequency oscillator in the light of the fore-

(Continued on page 68)

● ARMY-AMATEUR RADIO SYSTEM ACTIVITIES ●

IN accordance with the policy of having each Corps Area in turn furnish an article on their activities, the following was submitted by the First Corps Area.

On March 15, 1938, the New Hampshire State Department of the American Legion sponsored a state-wide mobilization test of all available equipment and personnel at their disposal under simulated emergency conditions. The result was very gratifying.

Some 5808 men and 2087 women, including 301 physicians and 323 nurses, reported their services were available. The use of 2990 passenger automobiles, 709 light trucks, 491 heavy trucks, 701 boats, 75 ambulances and 11 airplanes were reported available for transportation purposes. Facilities to feed and house 20,263 refugees could have been made available. Other equipment ready for use on short notice was: 73 short-wave radio stations, including 5-meter, 80-meter and 160-meter portable phone stations; one portable heating and lighting plant; twenty teams of horses; four oxen and 100 coffins. (One post prepared for the worst.)

Seventy-seven out of seventy-eight posts of the American Legion in New Hampshire reported ready for duty. Seventy out of seventy-four auxiliary units answered the call sent by the State Commander. No previous notice had been given, other than the announcement of a plan to attempt the emergency test during the week of March 14th.

At the last annual banquet of the New Hampshire State Department of the American Legion, mention was made of a plan endorsed by the National Department to organize the Department into permanent emergency units. At that time the State Net control station of the A.A.R.S., WLGB-W1FFL offered the facilities of the State Net, and plans were made accordingly. Each active A.A.R.S. station was instructed to have a portable 80-meter c.w. transmitter available to cover the Legion post in its territory. It was soon realized that, while the members would participate in a very interesting drill, the coverage offered by the twenty-three A.A.R.S. stations in the state would be limited. As many as six stations were located in a single town and while the central, eastern, southern and northern sections of the state were well covered, the western section was lacking an A.A.R.S. representative. A call sent out to brother hams in the NCR and A.R.R.L. was answered by quite a few stations and their fine cooperation helped to make the experiment a success.

WLGB-W1FFL, as net control of the State A.A.R.S. Net on 3735 kc. with relief operators W1GDE, W1CME and W1IP, at the first call reported to Concord headquarters. Another

message center was established in Concord with W1BFT as net control on the New Hampshire Emergency frequency of 3840 kc. This station with the aid of W1HOV, W1JCA and W1AWU, acted as intermediary between the portable emergency stations operating on 5 meters and the A.A.R.S. State Net.

Thirty-nine posts reported by radio through these net works, ably assisted by the A.A.R.S. 160-Meter Phone Net with W1IDY as net control.

Both Berlin and Nashua had five portable stations each, the latter having stations located at the Armory, police station and fire station.

This emergency test aroused considerable interest and had more participants than any since the flood in 1935. It proved beyond a doubt that the communications system could be bettered by having a single, or at most two, control channels. The efficiency of the radio nets suffered somewhat by comparison with the reports received by telephone from those posts without radio facilities, but there were four times as many telephone lines available as radio stations, which would not be the case under actual emergency conditions. Keeping in mind that the test was not one of speedy mobilization but rather an attempt to ascertain what personnel and equipment would be available in an emergency, amateur radio did a fine job. Amateurs who had been inactive for years participated in this test and several new members were signed up with the A.A.R.S.

* * * * *

A speed contest composed of five-letter code groups and transmitted simultaneously on the frequencies 3497.5 and 6990 kc. was broadcast by net control station WLU-W9BNT at Omaha, Neb., on March 14, 1938, to all A.A.R.S. members. The receiving conditions of that night were very poor in all sections of the country; however, copies were received from all Corps Areas. The transmissions were five minutes in length, ranging from 15 to 40 words per minute in jumps of five words per minute. The high members in each corps area are as follows:

VI C. A., W9KJY and W9JZY, with 30 w.p.m.
VII C. A., W9BNT, W9WRK, W9WGB and W9VSJ, with 25 w.p.m. IV C. A., W4AWO, with 25 w.p.m. V C. A., W9ZYC, with 25 w.p.m. II C. A., W2GGE, with 25 w.p.m. I C. A., W1IEG with 20 w.p.m. III C. A., W3AKB, with 20 w.p.m. VIII C. A., W6KFC and W9ESA with 20 w.p.m. IX C. A., W6KDI, W7GGW, W7FQC, W7EBQ, W6DVD, W6FQU, W6BMC, with 20 w.p.m.

* * * * *

Following is cipher message for all interested in ciphers: HTWZA HHWJC TAXZW WNPWY

(Continued on page 59)

Sixth A.R.R.L. Field Day Contest

Combine Portable/Emergency Set Tests and Outing, June 11th-12th

THE Annual Field Day is open to all W/VE amateurs¹ and dedicated to the testing in actual operation of sending and receiving equipment that will function self-powered for the occasion. The F.D. combines an outing with the opening of the season for outdoor radio activities. Operating time for the F.D. shown in logs must be between Saturday, June 11th (4 P.M. local time) and Sunday, June 12th (6 P.M. local time) for all points that count.

Only portable stations actually operated in the field (away from the "home" address) are eligible to submit field-day scores. Any or all amateur frequency bands may be used, voice or c.w. telegraph likewise. Advance entry is not required. The general call: (c.w.) CQ FD or ('phone) CQ FIELD DAY. The object is for each field-portable to work as many other amateur stations as possible in the time allotted.

To be prepared for emergencies requires that equipment be at hand, and the operator know what to do when power goes off, how to work without commercial power, how to send a message (proper order of parts) and show receipt for same, how to tune up workable antennas in "new" locations, how to make the most of low power, and many other things.

F.D. Scoring: Each station worked counts *one point* toward the score (but one contact per station allowed). Working other stations in the field, portable-to-portable at *both* ends of a QSO will count *two points* instead of one only. "Manufactured" contacts between stations of the same field group in the contest are *out*. All stations used by a single group must operate under the same call signal and portable designation and in the same "F.C.C.-notified" locality.¹ An extra credit of 10 points (before multiplier) may be claimed for originating not more than one message addressed to A.R.R.L. Hq., reporting the number of operators, the location, conditions and power (informative data on situations always needed at Hq. in actual emergency, too!). These extra points will count *only* if the message copy is submitted showing complete handling data, and word count (CK) must be correct as well as preamble complete in the right order.

The multiplier: Score may be multiplied by 2 if *either* the receiver or transmitter is independent of mains or commercial power source, by 3 if *both* transmitter and receiver are supplied from an independent local source. The following additional score multiplier is determined by the power input to the final stage (plate voltage times plate current—E X I).

- (a) Up to and including 20 watts—multiply score by 3.
- (b) Over 20, and up to 60 watts—multiply score by 2.
- (c) Over 60 watts—multiply score by 1.

The log of operation, claimed score, and data on power, frequency band and time of each contact should be listed, with the claimed total, and sent in promptly at the end of the tests. Be sure to note the source (s) of plate and filament power, along with the "watts input."

Clubs are all invited to encourage their members to build portables, and to arrange special Field Day activities. Club contests for emergency set-building of members should be instituted, as well as planning for higher power centrally located amateur-emergency stations where possible. Every amateur is invited to take part, whether or not able to participate in club plans. Your portable transmitter can be a source of great pleasure for the whole summer season. Get it working now. Take a couple of hams with you. Test it in the Field Day. Ask for application forms for registering equipment and availability, in A.R.R.L.'s Emergency Corps, if not already on record as a member of this organization.

Keep an operative portable at hand all the year. Use it at the mountains and seashore this summer. Design your station for "six-volt" tubes in exciter (and receivers, too) so they can be converted easily in emergency. Better yet plan gas-driven units for ample power, but don't deny yourself the ability and pleasure to set up in any location when supplementary links to important agencies may be required. Surprisingly efficient and useful equipment may be operated from vibrator-type, genemotor and battery power supplies.

Get in on this interesting, constructive side of amateur radio fun. Possible tube line ups for portables were given in June and August '36 QSTs, pages 43 and 39. About a dozen articles in your 1937 QST file give circuit information and data on self-power for emergency and portable transmitters. On receipt of a postal of inquiry we'll send a printed list of such QST references, with application form so you can register all station equipment in the A.E.C. We'll be looking for your report on the F.D.

—F. E. H.

¹ To comply with F.C.C. regulations for portable station operation, licensees in the U.S.A. have only to observe the instructions of par. 387-384 as respects advance notification of the location in which the portable will be operated, to the Inspector-in-Charge of the district, and as regards proper station identification (BT-1-2-etc.). Only on the 28 Mc., 56 Mc. and higher frequency amateur bands is portable work permitted without such notification. In Canada except for the inclusion of authorization to portables in the regulations for these u.h.f. bands, it is only necessary to ask special permission of the Radio Division, Department of Transport, for the work a VE-amateur has in mind for frequencies below 28 Mc.

A Simple One-Tube Receiver

A Straightforward Set for the Beginner

By T. M. Ferrill, Jr.*

INCREASING circuit complications to make more amplification possible with two- and three-tube receivers have so enlarged the difficulties with which the beginner is confronted that the usual "beginner's" sets of to-day seem almost as complex as the most elaborate sets of a few years ago. This means that a new amateur nowadays is almost compelled to make a study of set design and construction before he is ready to build even the smaller receivers.

The receiver described here was built expressly for beginning amateurs; it may easily be constructed at a surprisingly small cost by anyone with a very limited knowledge of radio. Because of its simplicity and freedom from freakish circuits, the set is almost certain to work properly at first trial, however inexperienced the builder.

Although only one tube is used, all of the requirements for satisfactory amateur-band operation are met. Sufficient amplification is provided on all of the frequencies covered, and the band-spread condenser simplifies the problem of tuning through the narrow amateur bands. In addition, the receiver is well-adapted to emergency and portable operation, and for this reason, the small amount of effort necessary to build it for an extra receiver is justified.

CONSTRUCTION

The receiver is built on a soft pine base $6\frac{3}{4}$ inches long, $5\frac{1}{2}$ inches deep, and 1 inch thick. The $\frac{1}{8}$ -inch aluminum panel for the set measures 6 inches high by 7 inches long. The panel is fastened to the base by two $\frac{3}{4}$ -inch wood screws, and in addition, two dime-store angle brackets with $1\frac{1}{2}$ -inch legs are screwed to base and panel to increase the rigidity of the assembly and thus prevent tuning difficulty.

* Technical Department, QST.

The 3-inch vernier dial on the center of the front panel is the band-spread tuning control. The pointer knob at the operator's left is on the band-setting condenser, C_1 , while that at the right is the regeneration control condenser knob. The three are mounted in a straight line, with holes centered $2\frac{1}{2}$ inches apart, three inches above the bottom edge of the panel.

After the panel has been attached to the base-board and the condensers are in place, the tube socket is mounted on the center of the base. This socket is held to the base by two $1\frac{1}{4}$ -inch wood screws through the socket holes and $\frac{5}{8}$ -inch tubing pillars supplied with the socket. The key slot is pointed directly toward the rear of the base-board, as it is shown in the circuit diagram.

The audio transformer and the coil socket are placed somewhat nearer the rear edge of the base. The audio transformer is mounted with primary connections at the side of the receiver and secondary connections near the tube socket. The spaced pin of the coil socket is located at side of the receiver opposite the primary connections of the audio transformer, so that it is possible to make direct connections to the terminals used.

The three condenser rotors are grounded to the aluminum panel, and are connected to the ground end of L_1 , to the audio amplifier cathode terminal of the tube socket (pin No. 1), to the ground end of the audio transformer secondary, and to the B-wire in the power cable.

The stators of C_1 and C_2 are connected together; a short wire is used to connect the C_1 stator to the grid end of L_1 ; and the grid leak and grid condenser, R_1 and C_5 , with terminal leads connected in parallel, are soldered to the stator of C_2 at one end and to the grid cap of the tube at the other.

For convenience in following the wiring of the set, the diagram is arranged with the socket con-

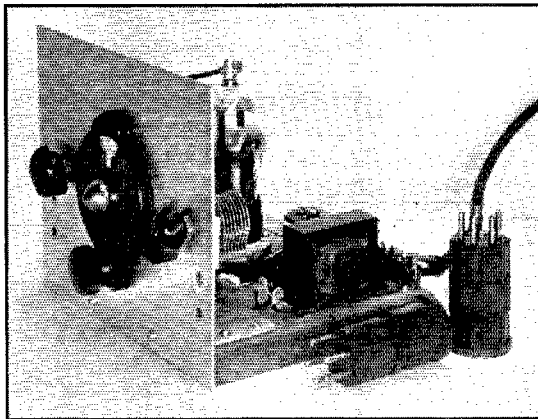

FRONT VIEW OF THE ONETUBE RECEIVER

Coils for the 80- and 40-meter bands are shown at the side. The dial in center of panel is the band-spread tuning control, with regeneration control knob at right and band-setting control at left.

nections just as they appear from above, and so it is not necessary to consult a tube data sheet for the various lug connections.

A cable of four conductors was used for heater and plate connections with this set, and to fasten the cable to the base-board, a four-lug terminal strip is screwed to the board at the rear edge. If desired, this lug strip could be replaced by a small clamp over the cable with one screw on each side, thus leaving the cable ends free to be connected directly to the proper points in the circuit. For the headphone tips, a terminal strip of two screws is provided, mounted also at the rear edge of the base. For this purpose a pair of tip jacks, or a combination of jack and phone plug could be used, if more readily available.

In the diagram, the antenna post of the receiver is shown coupled to the grid end of the coil, L_1 . Actually, it is not necessary to provide an antenna binding post; this purpose is served by simply twisting the antenna lead-in wire with a piece of insulated wire approximately 6 inches long, the end of which is connected to the grid lug of the coil socket. The insulated twisted wires form a coupling condenser, the capacity of which may be

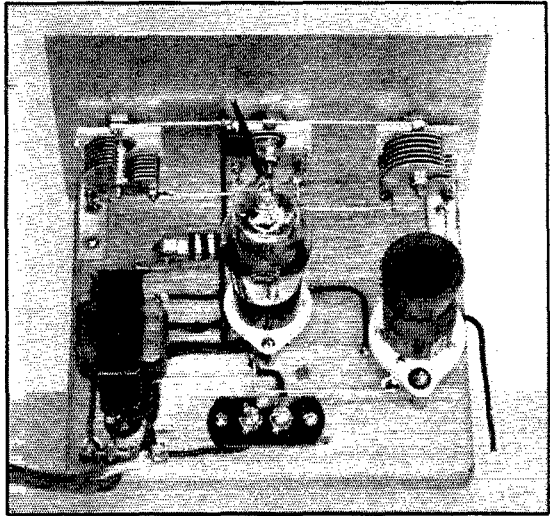

VIEW OF THE RECEIVER SHOWING WIRING AND PLACEMENT OF PARTS

This view clearly shows the simplicity of the assembly.

increased by increasing the number of times the wires are twisted around, thus increasing the length of wire in the twisted pair. For an antenna of approximately 50 feet, two turns should be sufficient.

Although the heater rating of the 6F8G is 6.3 volts, it was found that best operation of the tube in a receiver of this type is obtained with 3 volts applied to the heater. Actually, there is some variation of best heater voltage among different makes, although those used fell in this neighborhood, indicating that a supply of two dry cells or of the portion of a 6.3-volt center-tapped winding between center-tap connection and one end is quite suitable.

OPERATION

This set is not extremely critical in any respect, and, if the specifications given in the coil table are carefully followed, it should operate properly at the first test. Due to differences in the characteristics of tubes of different companies, however, it may be found necessary to move the cathode tap on the coil to some other point. This tap should be fixed on each coil so that the set goes into regeneration (as indicated by a light rushing noise) near the middle setting of the regeneration control condenser, C_3 . In order to determine whether this condition exists, the low-frequency coils should be wound first, and trial of the receiver should be made, to

(Continued on page 70)

L_1			
	Total No. Turns	Total Winding Length	No. Turns Between Tap and Ground
160-meter band....	110	Turns close-wound	12
80-meter band....	45	Turns close-wound	6
40-meter band....	14	Turns close-wound	2
20-meter band....	7	$\frac{3}{4}$ inch	2
10-meter band....	5	$\frac{3}{4}$ inch	2

All coils are wound of No. 30 d.s.c. wire on I.C.A. ribbed 5-prong forms, $1\frac{1}{4}$ -inch diameter by $\frac{1}{2}$ -inch winding length.

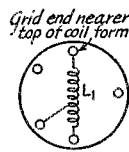
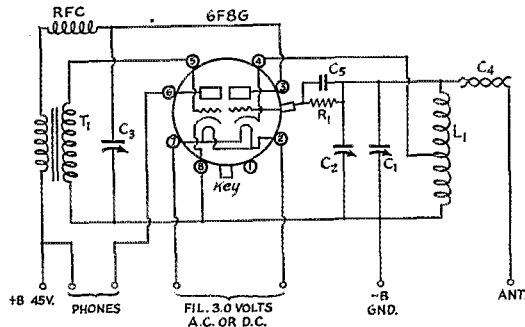

FIG. 1—CIRCUIT DIAGRAM OF THE ONE-TUBE RECEIVER

- C_1 —75- μ fd. band-setting midget condenser (Cardwell ZU75AS).
- C_2 —10- μ fd. band-spread midget tuning condenser (Cardwell ZR10AS).
- C_3 —75- μ fd. midget regeneration control condenser (Cardwell ZU75AS).
- C_4 —Insulated wire-ends, twisted (see text).
- C_5 —0.0001- μ fd. fixed mica condenser (Aerovox).
- R_1 —2-megohm, $\frac{1}{4}$ -watt resistor (IRC).
- RFC—2.5-millihenry choke (National R-100).
- T_1 —3:1 audio transformer (Thoradson T13A34).

A Final Amplifier Tuning-Matching-Coupling System

Continuously-Variable Loading without Taps on Moving Coils

By S. L. Seaton*

DURING the development of automatic multi-frequency equipment¹ for ionospheric recording, an antenna-coupling system was devised by means of which final tank tuning as well as matching between the final-amplifier tank and the antenna-transmission-line combination could be effected with but two controls. This system was later applied to communications transmitters with excellent results.

Basically, three tuning condensers in series are substituted for the usual tank-tuning condenser; the two outside condensers are operated together from a common control while the center condenser is separately adjustable. Transmission-line connections are made across the center condenser. In Fig. 1 a typical single-ended amplifier lies to the left of the broken line. L_1 is the tank inductance while C_1 , C_2 and C_3 are the tuning-matching controls. The extra condenser, C_4 , is used to allow driving a balanced antenna-feeder system from an unbalanced amplifier; its value is approximately

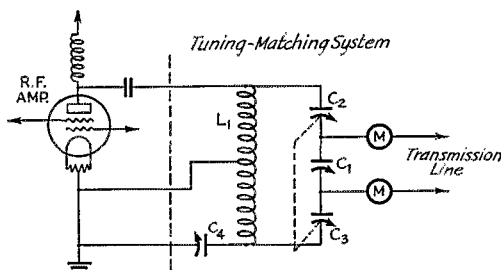

FIG. 1—THE TUNING-MATCHING SYSTEM APPLIED TO A SINGLE-ENDED STAGE

A neutralized amplifier could be used in place of the screen-grid tube shown; neutralizing connections would be made in the usual fashion.

that of the amplifier plate-to-ground capacity. In the case of a push-pull amplifier C_4 is not needed, since both ends of the tank inductance, L_1 , are at high radio-frequency potential. C_4 , however, is quite necessary when an unbalanced final amplifier is used, in order to bring both ends of the tank to approximately the same radio-frequency potential.

* Watheroo Magnetic Observatory, Watheroo, West Australia, Department of Terrestrial Magnetism, Carnegie Institution of Washington.

¹ Berkner, Wells and Seaton, "An Automatic Multifrequency Technique for Ionospheric Research," Fifth Conf. Phy. Math. & Ast., Sydney, N.W.S., May, 1936.

Ideal conditions would call for C_1 , C_2 and C_3 to be larger by several times than the normal tank tuning condenser, allowing the same value of L_1 to be used. However, if three standard condensers are used, for economic reasons perhaps, then the value of L_1 consequently increases to about twice its former value. Once the design of L_1 is obtained no trouble results in covering the entire channel, nor in designing other L units for other channels. If C_2 and C_3 are operated by separate controls their settings should be equal.

Adjustment of the unit is made by setting C_1 near mid-scale and rotating C_2 and C_3 until resonance at the driving frequency is obtained. Meter-readings are noted, then C_1 is adjusted, first one way and then the other, all the while following the resonant position for the tank with C_2 and C_3 , until maximum meter-readings are obtained for some definite combination of settings. Small neon lamps on the feeder wires are often a help, especially if the transmission line is not perfectly arranged. If unequal meter readings appear when adjustment is completed, a revision of the value of C_4 may bring about a balance; or if C_2 and C_3 are separately controlled a balance may be obtained by proper adjustment to unequal values. In any event, the sum of the meter readings being maximum together with brightest glow of the neon bulbs indicates the maximum power transfer. Either full on or full off position of C_1 indicates that it is necessary to shorten or lengthen the transmission line to obtain a "match."

In practice the operation of this tuning-matching unit is so satisfactory that former units have been permanently discarded.

Acknowledgment is made to the director, the observer-in-charge, and to associates in coöperation with whom this work was carried out.

Strays

Because of an accident which left him paralyzed, W5FVZ has to send c.w. with his mouth by means of a rubber tube terminating at an old earphone. When bent out of normal shape by air pressure, the diaphragm of this earphone closes a pair of contacts.

This probably makes W5FVZ the only c.w. operator who is likely to become hoarse as a result of continuous operating.

—W5FOP

The Fourth A.R.R.L. Copying Bee

INTEREST was high in the Fourth A.R.R.L. Copying Bee (December 10, 1937)! Two hundred and forty operators submitted copies of the 25 w.p.m. transmission. It was no ordinary copying competition. Text was comprised of trick letter combinations, misspelled words, punctuation, plain language groups, figure groups and unusual word combinations. To explain the text as several contestants phrased it—"it was a mess"! It required real ability to copy everything as it was actually transmitted. Guesswork was out.

The Copying Bee was conducted by stations W1AW, W2AYN, W9BAZ, W9UZ and W6AM. Frequencies in the 3.5 and 7-Mc. bands were employed, transmissions being at approximately 25 words per minute. Each text was comprised of 60 words or groups (punctuation marks each counting as one word). 1.7% was deducted for each word or group copied incorrectly, except that one-half credit was allowed for copying correctly "one side" of the parenthesis which was included in the message. Different texts, equally difficult, were transmitted from the east coast, central and west coast areas. It was necessary to submit a copy of one station only—the copy that the operator considered his "best."

Four operators made 100% copy, and to them is extended hearty congratulations! B. F. Borsody, W2AYN, made perfect copy of W9BAZ's transmission. Louis R. Clements, W2HHG, made perfect of W1AW. Victor C. Clark, W6KFC, copied three stations, ringing the bell with the copy from W6AM. Jack Richmond, W7GKZ, logged all four Copying Bee stations, the W2AYN copy being letter-perfect. Bronze medallion awards as pictured with this report are being forwarded to these code "de-jumblers."

Corrected copies have been returned to all contestants together with copies of the texts transmitted by the various stations so that each operator may see where he slipped up. Some errors plainly occurred when participants "re-copied" . . . but the judges can judge only the copies as submitted. For the umpteenth time may we urge upon receiving competition entrants—**DO NOT RECOPY!!** Submit your original copy.

FINAL RATINGS

W6AM was logged by 118 operators, W9BAZ by 82, W9UZ by 77, W1AW by 67 and W2AYN

by 54. 34.5% of all contestants made best copy from W6AM, 25% from W9BAZ, 19.6% from W9UZ, 10.9% from W1AW and 10% from W2AYN.

Participating operators are here listed according to accuracy of copy, ratings of 80% or higher being indicated; it should be noted that a rating of 98.3% indicates one error only—representing considerable ability!

100%: W2AYN W2HHG W6KFC W7GKZ.
98.3%: W1GEN W1KOM W2HAN W2KHY
W3GMG W4AIL W4CMN W5BJL W5BMI
W6FZL W8AQ W8AU W8BKM W9HUM
W9PBG. 97.4%: W9RLB. 96.6%: W1GBD



W2AYN, W2HHG, W6KFC AND W7GKZ ARE WINNERS OF THE BRONZE MEDALLION AWARDS IN THE 1937 A.R.R.L. COPYING BEE

W1IGB W2AJL W2ECL W3FSP
W6BMC W6LHZ W6MQS W6NSN
W8PSM W9PTU VE5HQ VE5IL.
94.9%: W1ALJ W1FPP W1GJB
W1IOE W3AKB W3CBF W3GBK
W4DW W5EGP W5ENI W6GFR
W6LUO W8APQ W8DOD W9CWR
W9DOP W9NEV W9VFO. 94%:
W9ANV. 93.2%: W1CKI W2CJI
W2GAC W4BIH W5CPB W5FZD
W6BMK W6LAI W6MUC W8ITK
W9HUZ W9PAN W9WYA. 91.5%:
W1FIK W2CHH W2GGW W3GKZ
W6MXC W7EBS W7ELF W9HCC
W9VKF W9ZQW VE5IC. 90.6%:
W3QM. 89.8%: W1KEH W3AKT
W3CMV W3EEN W3GBC W7WY
W8FIV W9RZA W9UUI W9VDA
W9ZHD J. Russell Thorburn.
88.9%: W6CZO. 88.1%: W3CRS
W3FPG W6JAB W7GBF W8HS
W9MWU W9YCR W9ZEW. 87.2%:
W2FPT/6 W4BAF W4CUP
W8BMK. 86.4%: W1KRB W2KBM
W3BWT W6MUR W9GLI W9LQO W9RQM.
84.7%: W3GHW W4ECZ W6BQO W7CMB
W7FAF W8BON W8OKC W8ORM W8QLE
W9FOC W9KUI W9RMM VE1EX. 83.8%:
W2KLP W9TSQ. 83%: W1ISH W1RR W2CRK
W2HUG W4EPV W6OGJ W8PVN W8QAN.
82.1%: W2KIG W6LPX W6PBV W8QML
W9FOQ. 81.3%: W1EZ W1LLR W4CRZ
W5CPT W5FCJ W8EU W9CEX W9IX W9TKN
W9WFS VE4CQ. 80.4%: CM2OP W4DWS
VE5KL. Below 80%, in order: W2APT-W2ELK-
W3DGM-W5ESL-W6KSX-W7GGW-W8AFE-
VP5CC W4DDF-W8RFF-W9KTD-W9VDY
W6KTQ-W7EBQ-W7LD-W8HCL-W9ICO-
W9KJX-W9MFH-W9OUD-W9UAZ-Miss Sally
Frenkelson (VE4CQ) W1GUA-W1JUC-W6OKL-
W7FFA-W8BKE-W8INK-W8QGD W2DXL
W1BQ-W2BWR-W3FFE-W6OVG-W9EI-
W9ZOU W2KTR W1ABG-W2KMZ-W3GYY-
W5KC-W6OAF-W8GSH-W9UUE-VE5SW

(Continued on page 66)

How Would You Do It?

Band-Switching Suggestions

PERHAPS the statement of Problem No. 16 in April *QST* was not sufficiently clear. At any rate, we are sorry to say that none of the solutions submitted could be considered as a direct answer to the problem as it was stated.

Numerous methods of band-changing have been described in past issues of *QST* and other publications, which have doubtless caused some confusion in the minds of many. Problem No. 16 was proposed with the idea of stimulating arguments in favor of one system as against others, considering all important points involved. It was

coil in the grid circuit of the second 53 push-push doubler. The two outside terminals of this grid coil connect to the grids of the second 53 and to the 7-Mc. points of the driver grid circuit switches. The tuned plate circuit of the second doubler is inductively-coupled to a third self-resonant center-tapped coil, the outside terminals of which connect to the 14-Mc. points of the driver grid circuit switches. Each doubler may be cut in or out of circuit by a pair of switches which opens the cathode circuits of the 53's.

Individual plate tank coils for the push-pull

driver are selected by another pair of three-position switches. Another pair of switches selects the proper driver output link while still another pair selects the corresponding input link coupled to the individual final amplifier grid coil. Individual

plate tank coils are also switched in the push-pull 203-A final amplifier. The final is coupled to the antenna feeder system through a pi-section filter equipped with short-circuiting switches. All sets of individual coils are arranged with the coil axes at right angles and with the highest frequency coil located closest to the switch to maintain short leads. Ordinary Yaxley receiving type switches are used in all circuits except the final output circuit. Here, heavier switches made by Communications Products are used. Where physical arrangement makes it practicable, switches are ganged.

Kenneth Uglow, W3FFG, has successfully incorporated band-switching in the 814 pentode transmitter with the Reinartz harmonic generator described in *QST* for April. Switches are provided for short-circuiting turns of each coil. Three feeder tuning condensers are used, two in series and one in parallel. The tip ends of the outside plates of both series condensers are bent so as to short-circuit the condensers when they are turned to full capacity for parallel tuning.

Gordon Jacobs, W8REM, finds that it is economically practicable to provide a simple oscillator for each band in a transmitter employing a pentode output tube. Excitation is switched by plugging a link line into the output of the particular oscillator desired and the grid and plate coils of the final amplifier may be plug-in or may be conveniently arranged for short-circuit switching.

Thomas Marshall, W1KFN, suggests coils which

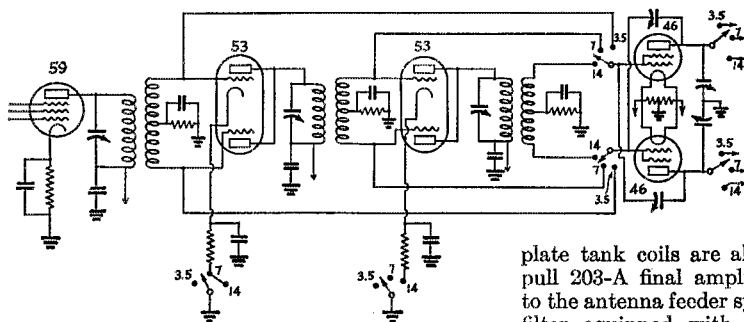

FIG. 1—BAND-SWITCHING ARRANGEMENT USED AT W4APU

The push-push doublers are cut in and out of circuit by means of switches in the cathode circuits.

felt that a series of well chosen arguments, by those who had had the experience, might be of considerable assistance to others who may be considering building a new transmitter or re-wiring an old one. All of those submitting solutions missed the point of argument entirely and confined themselves to descriptions of systems in use. Accordingly, we are forced to declare no contest.

Since many of the systems described have points of general interest, we shall run over a few of them.

Bennett Adams, W4APU, director of the South-eastern Division, has a five-stage transmitter with band-switching throughout. The first switch selects one of several 3.5-Mc. crystals in the grid circuit of the 59 pentode oscillator. The tuned plate circuit of the oscillator is inductively-coupled to a center-tapped self-resonant grid coil, the outside terminals of which are connected to the grids of the first push-push 53 frequency doubler and to the 3.5-Mc. points of two switches in the grid circuits of a push-pull 46 driver. The tuned plate circuit of the first doubler is inductively-coupled to a center-tapped self-resonant

plug in from the front of the panel similar to those used in the FB-7 receiver. The idea is particularly advantageous in exciter units built in rack-and-panel units since it obviates the necessity for getting into the rear of the transmitter for band-changing.

Fig. 2 shows an idea furnished by F. S. Andress, W4EOX, for returning a tank condenser to predetermined settings. Small arms made of spring brass are soldered to brass collars fitted with set-screws. Holes are drilled in the end plate of the tank condenser in the proper position so that the ends of the springs will snap into them when the tuning condenser is set to the desired capacity. The ends of the spring arms must be rounded so that they will not sink too deeply into the holes.

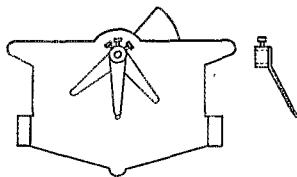

FIG. 2—AN AUTOMATIC STOP FOR RETURNING VARIABLE CONDENSERS TO PREDETERMINED SETTINGS

The condenser shaft is fitted with a stop for each setting desired.

Problem No. 18

ONE serious problem still confronting amateurs in general is that of interference with broadcast reception, particularly in congested districts. This interference may take the form of clicks, beatnotes, cross-talk or blanketing. It is probably true that less definite information is available on this subject than on most phases of amateur work. One reason for this may be that it is generally believed that no two transmitter installations will yield to exactly the same treatment. We believe that the schemes employed in several typical successful cases would tend to throw some light upon the subject and would be helpful to others. Therefore, this month we are offering the usual prizes for the best article on "How I Eliminated Interference with Broadcast Reception." The article should include suggestions for securing the cooperation of the B.C.L. as well as a complete description of the process followed in eliminating the interference.

Rules under which the contest is conducted are as follows:

1. Solutions must be mailed to reach West Hartford before the 20th of the publication month of the issue in which the problem has appeared. (For instance, solutions of problem given in the April issue must arrive at *QST* before April 20th.) They must be addressed to the Problem Contest Editor, *QST*, West Hartford, Conn.

2. Manuscripts must not be longer than 1000 words, written in ink or typewritten, with double spacing, on one side of the sheet. Diagrams must be neat and legible.

3. All solutions submitted become the property of *QST*, available for publication in the magazine.

4. The editors of *QST* will serve as judges. Their decision will be final.

Prizes of \$5 worth of A.R.R.L. station supplies

or publications will be given to the author of the solution considered best each month, \$2.50 worth of supplies to the author of the solution adjudged second best. The winners are requested to specify the supplies preferred.

A.A.R.S. Activities

(Continued from page 38)

HGJWX VMJHE MOMNH TIMNH TWHTW
 MJCMV UJMMO SNUAT MJIWA NXEWJ
 WZGJI HSNUH MLGHH TWMJC SNHML
 JAYHS YWLWJ SMXHT WJWEW JWAZM
 GHMNV TGNXJ WXOWN ANXXX LMOBL
 MVSLI HVZMW GSVFM ULIGF MZGVX
 IVZGF IVDZH TILLN VWZOO WZBOL
 MTWZB ZUGVI WZBSV XVIGZ RMOBO
 LLPVW ZXIVW RGGLG SVYZG GVIBZ
 GGSVV MWLUG SVDVV PVEVM RUHLN
 VDSZG QZVWW

Send answer to Liaison Officer, A.A.R.S., 3441 Munitions Bldg., Washington, D. C. Correct solutions will be acknowledged.

Strays

The Cover

This month we add to the series taken in *QST*'s lab. with a shot of Tom Ferrill of *QST*'s Editorial Department worrying up a new exciter-modulator destined, we hope, for early description.

We have it, via the grapevine, that W1JFG has been working on a red-hot directional antenna system, and to retain secrecy about the gadget, JFG has covered the system with a circus tent! (By the way, how does one go about getting a circus tent?)

The Spanish edition of the 1938 *Radio Amateur's Handbook* appeared in Buenos Aires on March 11th. Copies recently arrived here and we welcome it as a worthy companion to the original. Plans are being made for the Spanish translation of each new edition of the *Handbook*.

• I. A. R. U. NEWS •

Devoted to the interests and activities of the

INTERNATIONAL AMATEUR RADIO UNION

Headquarters Society: THE AMERICAN RADIO RELAY LEAGUE, West Hartford, Conn.

MEMBER SOCIETIES

American Radio Relay League
Asociatia Amatorilor Romani de Unde
Scurte
Associazione Radiotecnica Italiana
Canadian Section A.R.R.L.
Ceskoslovenski Amatérni Vysilaci
Deutscher Amateur Sende-und-Empfangs-
Dienst
Experimental Radio Society of Egypt
Experimenterende Danske Radioamatører
Federation des Emetteurs Belges
Irish Radio Transmitters Society
日本アマチュア無線聯盟 Japan

Liga Colombiana de Radio Aficionados
Liga Mexicana de Radio Experimentadores
Egyesület
Magyar Rövidhullám Amatőrök Országos
Egyesülete
Nederlandsche Vereeniging voor Interna-
tionaal Radioamateurisme
Nederlandsch-Indische Vereeniging Voor
Internationaal Radioamateurisme
Newfoundland Amateur Radio Association
New Zealand Association of Radio Trans-
mitters
Norsk Radio Relæ Liga

Polski Związek Krotkofalowcow
Radio Club Venezolano
Radio Society of Great Britain
Rede dos Emissores Portugueses
Reseau des Emetteurs Français
Reseau Luxembourgeois des Ama-
teurs d'Ondes Courtes
South African Radio Relay League
Suomen Radioamatööritto r.y.
Sveriges Sändareamatörer
Unión de Radioemisoros Españoles
Union Schweiz Kurzwellen Amateur
Wireless Institute of Australia

Conducted by Byron Goodman

Call Letters:

One of the functions of the International Telecommunications Conferences is to allocate the various call-letter blocks which, of course, determine the prefixes to be used by amateur stations. Groups are assigned to the various countries, and the amateur prefixes must be made up from one or more of these groups. A particular feature of the Cairo meeting was that, for the first time, all of the available letters (with the exception of A, B, and Q, which have never been assigned) were issued. This means that with the new list it is possible to identify every possible call, with the limitation that we don't know the breakdown within colonies and protectorates. Countries getting new blocks won't change their amateur calls unless they will have lost their old blocks. The changes in the previous list follow:

EIA-EJZ	Ireland	OHA-OJZ	Finland
EKA-EKZ	Japan	OKA-OMZ	Czechoslovakia
EMA-EOZ	Japan	SNA-SRZ	Poland
ERA-ERZ	Japan	SSA-SUZ	Egypt
EUA-EYZ	Japan	TDA-TDZ	Guatemala
EZA-EZZ	Germany	TEA-YEZ	Costa Rica
HCA-HDZ	Ecuador	THE-THZ	France and colonies
HEA-HEZ	Switzerland	TJA-TJZ	France and colonies
HFA-HFZ	Poland	VEA-VNZ	Australia
HGA-HGZ	Japan	VAA-VAZ	Australia
HLA-HMZ	Japan	XVA-XWZ	France and colonies
HNA-HNZ	Iraq	XXA-XXZ	Portuguese colonies
HOA-HPZ	Panama	YKA-YKZ	U.S.S.R.
HQZ-HRZ	Honduras	YXA-YYZ	U.S.S.R.
HTA-HTZ	Nicaragua	ZNA-ZOZ	British colonies
HUA-HUZ	El Salvador	ZQA-ZQZ	British colonies
HWA-HYZ	France and colonies	ZRA-ZUZ	Union of South Africa
ODA-ODZ	Syria and Lebanon		

These additions can be checked against the list in the Handbook and "Operating an Amateur

Radio Station." They go into effect on January 1, 1939.

Netherlands:

We join with the other member-societies in extending our congratulations and best wishes to Mr. P. C. Vis, PAOMQ, and Mr. L. J. v. d. Toolen, PAONP, the newly-elected president and honorary secretary of the N.V.I.R.

Austria:

A letter from ex-OE3AH, ex-president of the O.V.S.V., informs us that the D.A.S.D. has accepted the request of the Austrian society to become incorporated with the German Society. The president of the D.A.S.D. and his staff visited Vienna to celebrate the union of the two amateur societies. The O.V.S.V. has been formally dissolved. QSL cards (if any) now go to D.A.S.D.

France:

FRDS, secretary of the R.E.F., calls our attention to the fact that their membership fee is now about \$1.70 instead of the \$2.25 erroneously reported in the April issue.

Egypt:

When we were talking about the society publications we mentioned that the E.R.S.E. had a mimeographed bulletin. Since that time, however, their "E.R.S.E. Bulletin" has blossomed forth into a full-size magazine of which they can be justly proud. The March, 1938, issue had 32 pages filled with technical and general articles, section reports, and DX news. The

magazine is very well done, and this new society is to be congratulated on their splendid work.

The patron and honorary president of the F.R.S.E., H. H. Prince Abdel Moneim, SU1AM, has been quite active lately on 14-Mc. 'phone.

ED LAKER, G6LK, NEEDS NO INTRODUCTION TO INTERNATIONAL RADIO

WAC and WBE on both 'phone and c.w., G6LK is one of the best-known G's. The present station features separate transmitters on each band; the receiver is an HRO with DB20 preselector.



Incidentally his QSL card is about the most beautiful one we've seen. (And, issuing WAC's, we see plenty!)

QSL Bureau:

The list of QSL Bureaus published last month should be corrected as follows:

Germany: D.A.S.D., Cecilienallee 4, Berlin-Dahlem.

United States:

Odd though it may seem to Americans, we have had a number of requests from foreign stations working for their WAS to publish a list of the United States. Please note that a card from a station in the District of Columbia can be substituted for one from Maryland.

Alabama.....	W4	Nebraska.....	W9
Arizona.....	W6	Nevada.....	W6
Arkansas.....	W5	New Hampshire.....	W1
California.....	W6	New Jersey.....	W2, W3
Colorado.....	W9	New Mexico.....	W5
Connecticut.....	W1	New York.....	W2, W8
Delaware.....	W3	North Carolina.....	W4
Florida.....	W4	North Dakota.....	W9
Georgia.....	W4	Ohio.....	W8
Idaho.....	W7	Oklahoma.....	W5
Illinois.....	W9	Oregon.....	W7
Indiana.....	W9	Pennsylvania.....	W3, W8
Iowa.....	W9	Rhode Island.....	W1
Kansas.....	W9	South Carolina.....	W4
Kentucky.....	W9	South Dakota.....	W9
Louisiana.....	W5	Tennessee.....	W4
Maine.....	W1	Texas.....	W5
Maryland.....	W3	Utah.....	W6
Massachusetts.....	W1	Vermont.....	W1
Michigan.....	W8, W9	Virginia.....	W3
Minnesota.....	W9	Washington.....	W7
Mississippi.....	W5	West Virginia.....	W8
Missouri.....	W9	Wisconsin.....	W9
Montana.....	W7	Wyoming.....	W7

The 1851 in Communications Receivers

WHEN a new special-purpose tube is announced, the question of its application to ordinary amateur purposes inevitably arises, even though the designers may not have been concerned particularly with making a tube which will do a better job at communication frequencies. The new 1851 (characteristics were given in April *QST*) offers the possibility of obtaining several times the gain available from ordinary receiving-type r.f. amplifier tubes because of its high transconductance. Even more important, however, is the fact—not mentioned in the announcements—that the 1851 has less noise than the regular receiving pentodes.

With normal receiver design it is no trick at all to get a great deal more overall gain than is needed, so that the only advantage the 1851 might have in this connection is in raising the gain per stage and thus making possible a reduction in the number of stages in the receiver. Although economical, this does not make any real improvement in receiver performance. The lower noise level, however, really means something, particularly in the first r.f. stage of the receiver.

To find just what order of improvement might be expected from installing the 1851 in the first stage of existing receivers, measurements were made on two standard types, first with the normal tube complement and then with the 1851 in the first stage, suitable changes having been made in the bias resistors to give optimum performance with the 1851. In both cases there was a definite, although not large, improvement in the signal-to-noise ratio; the average improvement was about 1.2 or 1.3 to 1. The gain of the stage increased considerably, averaging about three times the gain with ordinary tubes.

On the other side, however, some not-so-desirable features resulted. The input conductance of the 1851 is lower than in the ordinary types, so that the grid circuit is more heavily loaded. Not only does this reduce the signal voltage (accounting for the fact that the actual gain realized is less than the theoretical, which should be five or six times that obtainable from a tube such as the 6K7) but also impairs the selectivity of the input circuit. In a receiver having one r.f. stage, the image ratio with the 1851 was just about halved as compared with its value with a 6K7. The input conductance and also the input capacity change with the voltages applied to the elements, so that both selectivity and tuning change with grid bias. The tube is not of the variable- μ type, so that it is not well suited to a.v.c. control, although it can be given a tailing characteristic by feeding the screen through a series resistor from the plate supply instead of through a voltage divider. If the 1851 is installed in a receiver having a common screen supply for several stages,

(Continued on page 86)

HINTS and KINKS for the Experimenter



Bias Supply for R.F. Amplifier

A SIMPLE and effective scheme for obtaining fixed bias for r.f. amplifier stages is suggested by W8OAH, Edward Eggebrecht, Grand Rapids,

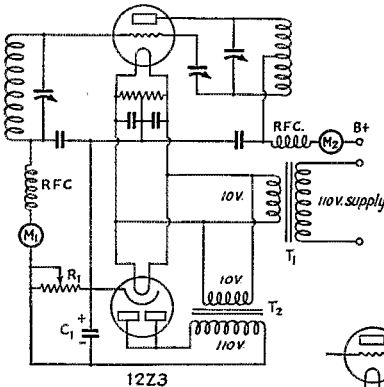

FIG. 1—CIRCUIT OF THE TRANSMITTER BIAS SUPPLY

Mich. One arrangement, shown in Fig. 1, makes use of a filament transformer with filament winding connected to the filament of one of the amplifier stages. The filament winding, or usual secondary winding, thus becomes the primary of a step-up transformer, giving approximately 110 volts at the terminals of the transformer usually used for primary connection. Thus, when the filament of the amplifier tube is heated, bias voltage is developed across the filter condenser, C_1 , and the combination bleeder and grid leak, R_1 , by the reversed filament transformer and the rectifier.

With plate voltage applied and key closed, the grid current flowing through R_1 produces the greater part of the bias voltage for the amplifier, whereas with no excitation applied, the rectifier-filament circuit maintains cut-off bias on the amplifier grid.

It will be noted in the diagram that the cathode connection of the rectifier tube is placed at ground potential, thus preventing a possible voltage breakdown between cathode and heater of the rectifier.

The condenser C_1 should have a capacity of from 8 to 16 $\mu\text{fd.}$, the latter value being preferable, and should have a voltage rating of from 450 to 600 volts, depending on the bias voltage which accompanies flow of grid current through the grid leak, R_1 .

It is advisable to make use of a high-vacuum rectifier rather than one of the mercury-vapor type, since the latter is likely to cause a slight disturbance while the receiver is in operation, the filament of the transmitting tube being heated throughout stand-by periods.

Fig. 1 gives circuit connections for use of a 10- to 12-volt heater tube as the bias rectifier. An 83V may be used with dropping resistor of $1\frac{1}{2}$ ohms connected in series with the heater, or a 12Z3 may be used (if the 12Z3 is used, a single plate connection is necessary, this being a half-wave rectifier). Although this latter provision does not place the rated voltage on the heater, 10 volts has been found sufficient for the very light duty imposed on the tube by a grid-leak resistor, R_1 , of reasonable size.

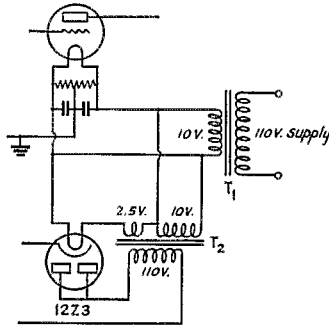

FIGS. 2 AND 3—ALTERNATIVE CONNECTIONS FOR THE BIAS RECTIFIER

Figs. 2 and 3 give alternative connections for rectifier tubes and filament transformers, the filter and bias connections with these arrangements being the same as those used in Fig. 1. The three diagrams given are for use with 10-volt tubes; however, similar simple arrangements for use with tubes of other filament-voltage ratings may be easily worked out.

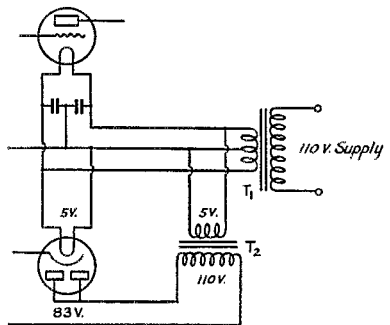

FIG. 3

Fig. 2 gives a circuit by means of which a 12-volt rectifier tube may be operated at its full heater voltage, if a spare transformer designed for 2.5- and 10-volt filaments is available.

Fig. 3 shows an arrangement using a center-tapped 10-volt transformer to supply bias voltage through a 5-volt transformer connected to half of the filament transformer secondary. The other half of the filament winding of T_1 is used to heat the 83V or similar rectifier tube.

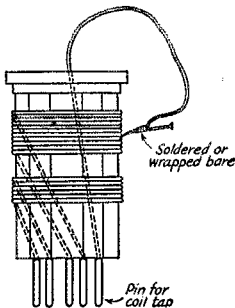

FIG. 4—LOCATION OF COIL TAP

Useful Kink for Locating Coil Taps

FIG. 4 shows the use of a common straight pin for locating points in plug-in coil windings where taps should be connected. This simple method may be used for coils with almost any type of wire. The coils are first wound on the forms in the usual manner for windings without taps, with care exercised to insure that the spacing of turns and windings is correct. A short piece of coil wire is then soldered at one end to a straight pin and at the other end to the tap pin of the form. In this way, the wire for the permanent tap connection is partially prepared; and, once the point for the tap is located, the wire may be fed through the side of the form and soldered in place.

The coil is now placed in the receiver; and while the set is operating, the pin is used to scratch through the insulation of the coil wire and is then stuck in place. If tuning the receiver reveals that a more desirable location for the tap should be found, the process is repeated until a satisfactory tap position is obtained. When the position best suited to the receiver is found, it is a simple matter to separate the turns slightly, so that a small drill may be used to make a hole for the tap lead. The pin is then removed, the lead is soldered to the point on the winding and the adjacent wires are moved back into normal position, completing the coil.

Enclosed Relay Rack for Amateurs

A HOME-BUILT rack in use by VE3SG, Fred H. B. Saxon, Toronto, Ont., is worthy of consideration by any amateur planning the use

of rack-mounted equipment. With this type of construction, small angle stock may be screwed to the sides of the rack, forming runners for the chassis units to slide in and out. Since the sides of the rack fit against the sides of the 17-inch bases, the bases may be drilled and tapped for screws through the side of the rack and in this way the complete assembly may be made perfectly rigid for shipment, if any moving is anticipated. An additional advantage of this type of rack construction is the ease with which it may be made, and the small amount of material and work, relative to other metal relay racks. In this unit, a heavy rib for drilling and tapping to take the relay panels is unnecessary; for with this arrangement, screws and nuts may be used, the nuts being outside of the enclosure and thus readily accessible.

The rack is made from steel of the same gauge as that used in heavy chassis. The sides are made by folding 1-inch edges out, front and back, to right angles. For the top, a box-shaped piece may be made from the same material, or a chassis of the usual length and of depth equal that of the largest base which the rack is to hold may be used, being simply screwed to the top edges of the sides, as indicated in the sketch of Fig. 5. Another such piece or chassis may be used at the bottom if

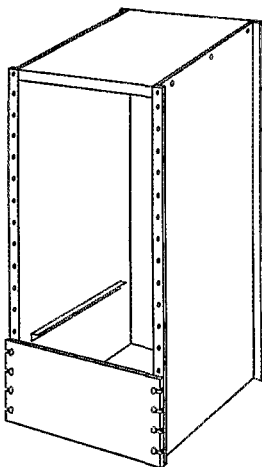

FIG. 5—CONSTRUCTION OF THE ENCLOSED RELAY RACK

desired. Alternatively, power supplies may be built up on a bottom chassis and panel, and this unit may be screwed into the bottom of the cabinet, front and sides, to provide a substantial and rigid base.

The front flange brings the width of the complete rack to 19 inches (for the common 19-inch panels; for 23-inch panels, the same method may be used with heavier-gauge metal). The depth and height of the rack for any station will, of course, be determined by the individual needs. The flange at rear edges of the sides is provided to give a balanced appearance and, more important, greater rigidity.

In order to make the front suitable for standard panels, panel holes may be spaced $1\frac{1}{4}$, $\frac{1}{2}$, $1\frac{1}{4}$, $\frac{1}{2}$ inch, etc., as explained on page 96 of *The Radio Amateur's Handbook*,

1938 Edition.

Templates for Meter and Socket Holes

A HANDY template for setting up a circle cutter is suggested by W1JEQ. Each time a hole is cut in prestwood or metal for mounting a large-diameter part, such as a socket, meter, or transformer, the circle removed from the material should be labeled and filed for future reference. A collection of metal and composition circles is thus

soon obtained, from which one corresponding to the part to be mounted may be selected. In order to adjust the radius of the circle cutter the circle is then slipped on the drill point of the cutter, and the tool is fitted to the edge of the circle and set. In this way, the time usually spent in setting up temporarily and cutting trial holes is saved.

—♦♦♦—

Tube Time Delay Circuit Applied to Remote Transmitter Control

FIG. 6 is the circuit diagram of a two-wire transmitter control and keying circuit, making use of the time-delay circuit of William P. West, *Experimenter's Section*, June, 1935 *QST*.

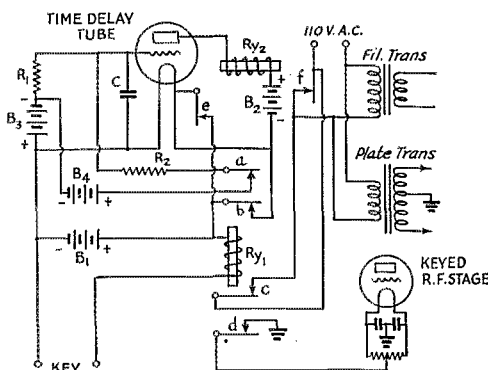

FIG. 6—CIRCUIT OF THE TIME-DELAY REMOTE CONTROL SYSTEM

Relay Ry_1 is a small four-contact (normally open) single-throw relay, operating on a small current at 6 volts. This relay is operated by the action of the telegraph key at the sending position.

When the key is depressed, this relay closes its four contacts, "a," "b," "c," and "d." Contact "c" closes the circuit from the 110-volt supply line through plate and filament transformer primaries; contact "b" closes the circuit of battery B_1 and the filament of the time delay tube, placing this tube in operating condition; contact "a" introduces the voltage of battery B_4 to cancel out the cut-off bias of B_3 applied to the time delay tube, permitting plate current to flow through this tube and thus closing relay Ry_2 . Contacts "e" and "f" of Ry_2 short contacts "b" and "c" of Ry_1 ; and since the resistance and capacity circuit in the grid section of the time delay tube are designed to maintain Ry_2 closed for a period of 15 seconds after the release of the key, the filament and plate transformers, as well as the filament of the time delay tube, remain turned on until a pause of fifteen seconds occurs in the transmission. When this length of time has elapsed, relay Ry_2 opens, turning off all power.

Starting the transmitter for each transmission is accomplished by either holding the key down

for about one second, or by preceding the transmission by the customary \overline{NK} , which allows time for the tube filament to heat and the relay Ry_2 to become operative.

The convenience and certainty of operating without the necessity for pushing buttons or throwing switches will be appreciated by the amateur who has never used such a system, and the practicability of controlling the transmitter from a number of points, remote and local, through paralleling any number of keys, will be well worth the effort expended.

—T. J. Eubanks, W8VK

By a slight addition to the circuit, so that 110 volts would be applied to the primary of the plate transformer by contact "f," relay Ry_2 , alone, whereas the primaries of all filament transformers would be closed by both contact "c" and contact "f" as shown, the filaments of the rectifier and transmitting tubes may be heated before application of plate voltage, using the same two-wire system. Furthermore, an indirectly-heated cathode tube of the six-volt type may be used for the time-delay circuit, insuring that the filament heating time will be ample.—EDITOR.

—♦♦♦—

Voltage-Breakdown Tests on Power-Supply Components

THE purpose of this suggestion is to point out a method whereby amateurs may avoid the exasperating experience which accompanies voltage breakdown in completed power supplies. The feeling of certainty which results from actual tests of the parts before they are assembled and wired into the amateur-station power supplies is well worth the small effort required by this system.

For making the test of power supply apparatus, a source of much higher voltage than the output voltage of the completed power supply must be available, and for this source, the power rectifier plates in a full-wave power supply (choke input supply) is given by multiplying the output voltage by approximately 2.5. The peak voltage between the rectifier plates is given by multiplying the output voltage by approximately 4. Lower peak values of voltage may be obtained by use of secondary center tap, and other secondary taps if any.

The only other apparatus necessary for the test is a large resistance for connection in series with the portion of the secondary winding used and the part being tested. This resistor becomes very important if breakdown occurs in any piece tested, for disaster to transformer or fuses might follow a breakdown. For this protective resistor, the bleeder of the power supply serves admirably. Thus, the two necessary pieces of equipment necessary to perform satisfactory tests of the

(Continued on page 68)



OPERATING NEWS



Conducted by the Communications Department

F. E. Handy, Communications Manager

E. L. Battey, Asst. Communications Manager

QSA-QRK-systems came in for subcommittee discussions as one of the minor developments of the Cairo Conference that may be of interest to amateurs. It seems that the rest of the world found difficulties, as we amateurs did, with the present QSA 1-5 definitions confusing readability and strength. The present QSA system of definitions does not provide for strong signals that cannot be read, and weak signals that can. Of course we amateurs devised our own complete and generally satisfactory RST reporting plan just to get around this difficulty.

After some weeks of deliberation and debate, a new plan was adopted in the Cairo subcommittee. The new appendix of "abbreviations to be used in all services," the Q-code, part of the General Regulations annexed to the new international telecommunications treaty and probably effective January 1, 1939¹ will undoubtedly contain the following new definitions for official international use:

Strength table

- QSA1—Barely perceptible
- QSA2—Weak
- QSA3—Fairly good
- QSA4—Good
- QSA5—Very good

Readability table

- QRK1—Unreadable
- QRK2—Readable occasionally
- QRK3—Readable with difficulty
- QRK4—Readable
- QRK5—Perfectly readable

- QRK? What is the *readability* of my signals? (1 to 5)
- QSA? What is the *strength* of my signals? (1 to 5)

The committees in working on a clarification of the QSA-definitions to replace the meanings that are official until 1939 had all our RST-data on the satisfactory system all amateurs now use available . . . and in the new Q Code (QRK) readability table (for 1939) we think we see some definitions that come right out of our book. If so, it is not a bad compliment to the amateur radio service, indeed!

Commas vs. periods. There is a possibility that a change in international Morse Code will be promulgated in our United States practice starting in 1939, also . . . but we hope it is a possibility that doesn't arrive! Here's the story. The telegraph treaty to which the United States is not a party was also under revision. The telegraph²

conference requested the radio conference to concur in adopting a change whereunder a period would be indicated by the present symbol for a comma, and a comma would be indicated by the present designation for the exclamation point. This all resulted from the complaint of some operating company that its telegraph printer rendered periods as three letter I's! For some reason no one happened to be on the spot with the logical objections, so the story goes that the small subcommittee decided to concur, and *that* without making any suggestion concerning how exclamation points might be transmitted for the future. (Hi) The work of the subcommittee on approval in plenary session became an approved action of the radio conference. While there is some doubt whether our practice will be altered, it is the consensus that the official change will have to be made. It is a matter of import to all operators and on all circuits where Continental code is used. We shall learn, by 1939, whether the fact that one small commercial group was out of step, is going to upset the satisfactory practice, operator training and custom established in the thirty-two years since the Berlin adoption (1906) of international Morse for radio work. It seems to us that there should be other ways of correcting the inadequacy of a particular mechanical system without introducing such confusion for the rest of the operating world. Personally we like to be able to send our exclamation points, too. The change discussed would leave us helpless. MIM!

June 11th-12th, A.R.R.L. Field Day. Advance inquiries show tremendous general interest in this event combining an outing with the testing of portable and emergency equipment. Tests of low power stations, self-powered, under conditions of isolation from commercial power sources give a thrill of pride in accomplishment that is above and beyond that obtained from customary QSO's—with plenty of power to spare and with all modern station aids. Try it and see for yourself!

Choice of bands and equipment is left to participants. High-powered gasoline-driven stations are ideal for clubs to develop as dependable community center stations for emergency, but of course relatively few can afford to install gasoline drive, so we cannot require the use of high power. Intermediate power stations supplied via Vibra-

¹ Frequency allocations tables of the treaty are not to be effective until Sept. 1, 1939.

² The European wire telegraph circuits use continental (International Morse) code, instead of the distinctive American Morse code used on land wires here.

packs, Genemotors and storage cells and operated by skilled operators have proved highly efficient in past Field Days and in emergency work. The power handicap brings the contest to the level where any individual can compete with individual self-power.

Our rule that permits using more than one transmitter, as long as it is F.C.C.-reported for one locality and call and responsibility is designed to encourage amateurs and individuals to build as many good low- and intermediate-power transmitters as possible. Surveys have shown that we do not have enough self-powered sets generally distributed within the fraternity. The Field Day appropriately continues to encourage amateurs to equip with units so that every amateur station may be able to shift to six volts and emergency power in event of unexpected need developing! The more such stations we have, the less likely the possibility of isolation for any community following hurricane or other disaster, for any great length of time. Operator training in communicating, in the procedure of setting up and in formulating a complete message properly, is all of value with an eye to possible disaster contingencies—and use of amateur radio.

So the Field Day is dedicated to *preparedness*. We should like to see clubs conduct competitions in their memberships looking toward building of individual apparatus for future emergencies. Building and testing equipment, and operator training too, are all important!

The Field Day is for radio clubs, groups, and individuals. There is more fun in "doing things together." The fellowship, fraternal relationships, and practical lessons in overcoming the problems imposed by nature in establishing and operating a station intensively bring out the best there is in operating. There's a thrill in operating afielnd not duplicated otherwise—however large or small the group—whatever the conditions. Try it, and let us know if you don't agree. Here's luck in the F.D.

—F. E. H.

Briefs

There were fourteen in attendance at the regular meeting of the Los Angeles Emergency Committee, called by Larry Lynde, W6DEP. Besides amateurs, there were representatives from the power company, gas company and city police force. Among matters discussed is a plan for ten Los Angeles amateurs to install 10-watt 28-Mc. 'phone rigs in their cars for emergency service.

Archbold New Guinea Expedition—PK6XXX

Operator Harold G. Ramm (W2BYE) of the Archbold New Guinea Expedition writes from Java that the expedition has been assigned the call PK6XXX. The expedition was due to arrive in Hollandria, Netherlands New Guinea, on April 22d, and will be on the air by the last of May using the 14-Mc. band, with shifts to 7 and 3.5 Mc. at times. Frequencies of the commercial set at the base station will be 500, 6425 and 11,355 kc. with airplane frequencies of 3105, 6210 and 12,420 kc. All contacts with or reception of PK6XXX should be reported to A.R.R.L. for expedition acknowledgment certificate.

PRIZES FOR BEST ARTICLE

The article by Mr. R. C. Woodward, W7FKC, wins the C.D. article contest prize this month. Each month we print the most interesting and valuable article received marked "for the C.D. contest." Contributions may be on any phase of amateur operating or communication activity (DX, 'phone, traffic, rag-chewing, clubs, fraternalism, etc.) which adds constructively to amateur organization work. Prize winners may select a 1938 bound *Handbook, QST* Binder and League Emblem, six logs, eight pads radiogram blanks, DX Map and three pads, or any other combination of A.R.R.L. supplies of equivalent value. Try your luck. Send your contribution to-day!

A Chance to Help

By R. C. Woodward, W7FKC *

WE ALL agree that amateur radio is the finest of all the hobbies. According to our inclinations we pursue it in all its phases of construction, experimenting, traffic, DX, and rag chewing. We all know the pleasure and benefits to be gained and we are glad to see others join us and share these things. The writer would like to call attention to a class of fellows for whom these things are difficult to enjoy.

It is those who are physically incapable of building a station. We loosely group them under the term "shut-ins." The few of these who have stations no longer consider themselves "shut-in" and they get far more out of operating a station than the average healthy ham.

You who are members of a radio club can add a worthwhile activity to your club work by seeking out those handicapped ones near you who would make good ham material and helping them get on the air. There are those who would be on the air long ago if they were able to crawl around on a roof to put up a skywire. For others the obstacle is not having the strength or equipment to build rigs, it being hard to do that sort of work while lying in bed. Some might need the benefit of your experience in adjusting a rig.

A little help with code practice or an explanation of theory may mean the successful passing of the class C examination. You who can go around to the other fellows' shacks unconsciously absorb many things that are the despair of one going it alone. It isn't all in the textbooks.

You will find those who cannot afford a rig made of new parts and they are not able to prowld the used-parts places. Some cannot afford even ex-BC stuff. A donation from the junk box of each club member would make up a rig that would be the eternal delight of one of those fellows.

Obviously you can't make every shut-in a ham. Some will not be interested and others not mechanically or electrically inclined. But if you run across one whose eyes light up over DX yarns, who listens to the short wave side of their BC job, who has invented some gadgets to help him in his ordinary daily routine, who is a stamp collector, or who writes letters in an effort to make outside friends, that fellow is good ham material.

The writer knows several shut-ins who became hams and later put their knowledge to use in servicing and are partially or wholly self-supporting. The therapeutic value of semi-active hobbies such as amateur radio is widely recognized and sometimes is the incentive leading to complete rehabilitation.

This letter is not intended to be a tear-jerker over the lot
*5226 Eleventh Ave., N.E., Seattle, Washington.

of the shut-in. The average shut-in does not feel that way about himself. If he does he will not make a good ham. But if clubs and individual hams will think it over, sort a gadget or so out of the junk box, and hunt themselves up a prospect or two, and either lend or give them a small station, they can rest assured it will be put to good use.

There is more to the problem of getting a shut-in on the air than building of the rig. It must be so built that he can operate it easily and above all safely. Suppose that your prospect is blind. Very likely he will be able to do a great deal of the construction himself but would not know of the existence of a lot of gadgets that would make things easier. For instance, an ordinary dial on a receiver would prevent him logging a station. If the dial degree marks were raised by building them up with enamel with distinctive shapes at ten degree intervals he could tell where the dial was set by feel. And a metal pointer instead of a mark for the reference point would help. Even better would be a dial of the type used on the FB7 receivers. For the blind, do not forget the Braille Handbook that was recently announced in a *QST* editorial. Perhaps your local library will have a set.

For any shut-in (well people for that matter) it is an absolute must that there is no chance of touching a "hot" lead. There should be some rugged master switch to shut off all power in the shack easily and quickly. If a fire started your shut-in may be unable to run away from it, so see that there is no chance of it starting. Group all tuning controls as closely as possible. It may be that your new ham can move his hands just a few inches. For that reason potentiometer regeneration control is better than condenser on that type of receiver. Deep slots sawed in dial knobs and a schoolroom pointer sharpened like a screw driver will let him make his own adjustments sometimes. Or a pencil eraser on the end of a rod could be used like the old vernier dials. If he can't get close enough to the receiver to tune it comfortably one of those flexible dial drives might help. In working on rigs things are forever dropping on the floor. If he can't reach the floor an alligator clip on the end of a shaft makes a good "picker-upper." Bend the thumb piece on the clip at right angles and run a wire from it up the shaft to a trigger arrangement.

A small portable switch box with several toggle switches in it will help for remote control to a bed. Use husky leads! With the transmitter remotely controlled the receiver can be mounted on a swinging shelf over a bed. One of the old-fashioned typewriter shelves they used to swing from the side of a desk is FB.

Operating from a bed a keying relay is almost a necessity. Some will not have the strength to operate a straight key with its up and down motion. A bug solves that. Home-made ones will do for slow speeds. Your shut-in will probably do a lot of operating after his family has gone to sleep. Mount the keying relay on some sponge rubber and let 'em sleep!

If there is a meter in the plate circuit of the transmitter he might want to keep an eye on it. He may have a stiff neck and can't turn his head. A small mirror at the right spot fixes that.

He may be in a wheel chair. Perhaps he cannot reach a key in the ordinary position on the table. Put on the end a light board four inches wide and about two feet long he can hold it down to the chair arm with his forearm and key nicely. It might be fastened there with brackets or made demountable. Perhaps he cannot reach out to key at all. A small shelf to hold the key or bug fixed so it will fit over the front of a drawer in a table will enable him to pull the key and shelf as close as he wants it.

These are a few of the ideas gleaned from the writer's correspondence with other shut-in hams. Study of the individual case will suggest others. The partially handicapped will enjoy doing as much of the work as he can and it is good for him that he does. Lots of times dropping in on him on your way to the radio store to see if he needs anything from there is all that is necessary. His own family may be willing to run his errands but it takes a ham to buy ham equipment intelligently.

Look around your town and see if there is not someone who would enjoy ham radio as much as you do if he had the chance. Once started he will probably put in more time at it than you do.

The writer wishes it understood that this is not a personal appeal. He has a hundred-watt station on the air. This would not have been possible were it not for the kindly efforts of W7APS, W7EEJ, W7EVO and others.

Hamfests Coming Up

May 28th-30th, at Fargo, North Dakota: "Fun on Five at Fargo" is the slogan of the "funfest" at which Fargo, North Dakota, amateurs will be host to fellow hams from the Dakota Division and neighboring Canadian provinces. Sunday afternoon will feature a 56-Mc. hidden transmitter hunt. Monday will have a surprise event. Headquarters for the get-together will be at the Chamber of Commerce building. The committee in charge, composed of W9EIG, W9LHS, W9RPJ, W9SHI and W9ZVE, extends an invitation to everyone to attend and share in the fun.

June 11th-12th, at Burlington, Iowa: The Iowa Illinois Amateur Radio Club will hold its Annual Hamfest and Technical Clinic at the Hotel Burlington, Burlington, Iowa, on the week-end of June 11th and 12th. Registration and Smoker on Saturday evening. All-Day Session in Banquet Hall Sunday. Nationally known speakers, lots of prizes. Tickets \$1.75 in advance, \$2.00 at the door. For further information get in touch with W9ARE, 815 Dunham Street, Burlington.

June 12th, at Council Bluffs, Iowa: A 56-Mc. Treasure Hunt will be staged by the Council Bluffs Radio Operators' Club on June 12th. The actual hunt will start about noon, with two or three hours allowed for finding the hidden rig. Prizes for the winners, as well as door prizes. A picnic will follow the hunt. For details write Bob Brenneman, W9UQJ, 3640 8th Avenue, Council Bluffs.

June 19th, Eastern Ontario: The Ottawa Amateur Radio Transmitting Association announces a hamfest for Eastern Ontario, June 19th. The place: Ault's Park, on Shiek Island in the St. Lawrence River, near the village of Mille Roches. This village is on Ontario highway No. 2, about five miles west of Corwall. Signs will be posted on the highway showing the turn to the river. Starting at 10:30 a.m., activities will continue all day. Price will be only 25¢. The program will be varied—aimed to please everybody. Hidden transmitter hunts for both 56- and 3.5-Mc. equipment will be held. To complete the picture, there will be a good assortment of prizes.

June 26th, at Round Lake, Wisconsin: The Fox River Valley Affiliated Radio Clubs will hold their Sixth Annual Hamfest at Round Lake, Wisconsin, on June 26th. Reservations may be sent to Christ Bauer, W9NVJ, Secretary, 1413 North 8th Street, Sheboygan, Wisconsin.

September 3d, 4th, 5th, at Cranbrook, B. C.: The East Kootenay Amateur Radio Association invites all amateurs to a hamfest to be held September 3d, 4th and 5th at Cranbrook, British Columbia, near Banff, Lake Louise, Radium Hot Springs. Attractions: Big get-together; visit to largest lead, zinc, silver mine in the world at Kimberley; prizes; sports; amusements; also Cranbrook's Fortieth Anniversary Celebrations. For complete information write to Mrs. K. R. Barber, VE5SI, Chairman of the Committee, 302 Van Horn Street, Cranbrook.



How's DX?

How:

There isn't any doubt that the Century Club has given new impetus to the idea of exchanging QSL's. Several of the hams we know who used to disregard QSL's, and always chucked cards in the wastebasket, have suddenly changed their whole attitude. Rather than deal in personalities, let's take a typical case of a DX'er going after the Century Club award.

First he reads about the thing in *QST*. "Hmm," he says to himself, "I've got plenty of cards around for that." He checks his cards and log, and finds that he's worked 106 countries but has cards from only 62, because he never bothered about them before. He blissfully sits down and fills out cards for stations in the non-QSL'd countries. During the next two or three months he receives 11 cards, bringing his total to 73. "Well," he says, "I'll give them another blast," and this time he sends a self-addressed envelope. This brings in 8 more cards, and in the meantime he has worked a few more countries and also found out that he can get confirmation from four more countries through the DX Contest logs. By now he's in a dither because his arch-enemy W-whoosis across town is also catching up, and so he sends another round of cards, this time with self-addressed envelopes and international reply coupons. If this fails, the later methods depend entirely upon the ingenuity of the individual. Some send heart-rending letters that would bring tears to the cold eyes of Fagin. Some think that a nice chatty letter passing the time of day and incidentally mentioning QSL will start a beautiful friendship that will end with a card. Others, more ingenious, print up an actual QSL and send it to the station, asking that it be filled in and returned. (We've never heard of this working, though.) One smarty got a well-known DX station that wouldn't reveal his street address to cable confirmation, but he was so smart that he had the DX station just send the word "phoney," assuming that the code word would serve in lieu of a long text that would cost more. But the Century Club moguls wouldn't accept it! Other fellows seem to think that HQ men have the magic touch, and send their cards here with a request that we forward them. Heck, we're in the same boat with the rest of the fellows.

Seriously, though, we have tried to get lists from some of the DX stations who, being the only active one in the country, have found it impossible to comply with all requests for cards. We have a list from YV2CU, and all CC aspirants are credited with this country (we still can't name it for you) if their call is on the list. We're trying to do the same with 17AA. OX2QY has already furnished several lists.

Where:

One of this month's mysteries is CR6PG. Worked by a number of fellows (including W3FQP, W1AJ, W1SZ, W1WV, W8JIW, W5EOW and W5ENE) on both 40 and 20, he has given just too many conflicting reports. He tells some to QSL via A.R.R.L. and to others he gives addresses that don't check. Until we hear otherwise we'll tab him a phoney. We hope we're wrong W8OXO knocked off a good one: PX1A (14,425 kc.) If you worked HR5C you can send your card (under cover, please!) to E. C. Connell, N. Y. & H. R. Mining Company, San Juanito, Honduras Cards for HCAC should go to Box 604, Guayaquil, according to W8ACY It isn't every day that we get the boss working for us, so we're going to take full advantage of W1EHH's investigations while at Cairo. First he tells us that EP5SO (also VL5SO), who was on the air in Iran for a bit, is now off for a spell. He is ex-G5SO, and QSL's should go to his brother, G2TR. KB says that ZC6AQ and ZC6RP (7225 kc.) are the only active Palestine stations, but SUIWM later supplemented this with the information that ZC6AQ is returning to England

and that ZC6AA (14,285 kc., T8) is a new active station. ZC5AY is apparently a phoney. SUIAM, H. H. Prince Abdel Moneim, has a 100-watt 20-meter 'phone rig that is getting into the States well A lot of queries about ZD2H (14,270 kc., T9) have been received. W2HHF kicks through with the dope that his QRA is Art Tomlinson, Posts and Telegraph, Lagos, Nigeria. He is ex-G2QN. Liscum also reports hearing FL8AB (14,415 kc., T8) which, if he isn't a phoney, would be in French Somaliland W8DHC gives the QRA of HI2W as Luis Morales, Ciudad Trujillo, Dominica WE3NE offers to forward cards to HRO and HR7WC (they're the same). But give Ben a break, and enclose a stamp, and you'll get a card in return W8LZK worked VQ2FJ (14,040 kc.) and VQ2JC (14,095 kc., T9) in Northern Rhodesia. 2FJ is swell about coming through with a card in a hurry. His QTH is C. F. Jones, Box 9, Luanshya, Northern Rhodesia And W8JSU has one for the boys: VSSAB (14,330 kc., T9) Those VK9's are getting active, and in addition to VK9DM (14,400 kc., T6) we have heard of VK9VG (14,070 kc., T9) And W3DDM reports VK4HN (14,285 kc.), which doesn't sound interesting until you know he's in Papua. Incidentally, W3DDM expects to be XU6DDM in the near future You probably know that VR4AD (14,300 kc., T9) has been batting them off recently. He has been running a sort of one-man DX contest with himself, giving the boys a chance for a Solomon Islands contact. He'll be off until May 29th, but will then resume Look for VR2FF (14,080 kc.) until 1230 GMT. His power is shut off then! W6KBY reports working ZC2CF (14,320 kc.), a ship that said he was near Tonga Island. We are beginning to adopt a somewhat skeptical attitude, however And just in case you think the skepticism isn't justified, W9FS worked ZB2O on Adrian Island, which must be a new island or something The dope we had on the Soviet Search Expedition last month was approximately correct. VE3QV, who operated RUPUL at Akdaviik, writes in and clears up the situation. It was RUPUL that had the 2-watt job. So you weren't being kidded if you worked RUPUL or RUPULB The QRA of U8IB is W. T. Adwee, Niabekskis Str. N. 35, Tachkent, U.Z.S.S.R. W3GXX would like more dope about LZ7AN (14,025 kc., T9) supposedly in Bulgaria. (There's that skepticism again!) If you didn't get G8MF in the Channel Islands, who incidentally warmed many a heart by finally coming through with cards, you might lay for G8DO (14,370 kc., T9) We're almost of a mind to quit listing these screwy ship calls, etc., but you'll want to know that PU2U is a ship in the Bahamas. KP9 (what a doggy call) was worked by W8LAP. W2JMQ worked XL5J and W1HWH worked KR7E, both supposed to be up North somewhere, and W5EOW has run into ZMZN, Z09R, ZB1ACBA and SW3 W8IGQ was through here the other day, telling of his experiences on WCFT. He made mention that VR6AY will probably continue to operate on the ham bands, contrary to last month's item. All of which should lighten a few hearts W9VDY says K6MV (14,008 kc., T9) is on Midway Island and, of course, you know about K6BAZ (14,335 kc., T8) on Howland Island W6KUT worked FP8AM (14,370 kc., T7), who gave his QRA as Jules Rome, Miquelon Island. Ed was a bit chagrined to find that TI2AB, YS2AB and YN2AB were all one fellow on a coastwise cattle boat.

When:

Every time we about give up on 7-Mc. DX we pass a nasty remark about it and immediately someone comes to its defense, usually with some prime stuff. This time it's W4CEN, who tells that he worked SV6SP (7240kc., T8) in Crete during the Contest, and heard AR8MO (7200 kc.,

T8). Jeeves, have you put those new shunts in the 40-meter rig yet? And W2KIK worked K4ERY (7265 kc.) in the Virgin Islands, HK4EA (7300 kc.), and YV1AD (7100 kc.).

K4KD drops us a card to tell about things down that way, and says that the latest includes YTT7J (14,430 kc., T8), UK8IA (14,350 kc., T7), PZ1AB (14,450 kc., T6), VP7NT (14,405 kc., T9), SV1AZ (14,315 kc., T7) and SP1EB (14,420 kc., T8). He still needs Nevada, Wyoming and South Dakota for WAS W2HHF is knocking 'em off again, and some of the best from his long list include XSV1SM (14,400 kc., T8), a ship bound for Buenos Aires, VS7MB (14,400 kc., T9x), worked at 8 p.m., J2OV (14,140 kc., T9), YR5KW (14,395 kc., T9x), I1ND (14,360 kc., T6), CN8MB (14,040 kc., T9), OA6U (7001 kc., T6), LX1AS (14,405 kc., T7), XU8OL (14,385 kc., T8), ZB1U (14,300 kc., T8), LY1S (14,040 kc., T9), VQ4CHS (14,040 kc., T9), and U6WB (14,410 kc., T9) W2CYS adds KA1AX (14,270 kc., T8), JZ1LK (14,310 kc., T8), J2KG (14,265 kc., T8), XU2BM (14,260 kc., T9), ZC6AA (14,325 kc., T9) and XU8LS (14,300 kc., T9) CM2AO lists PK1MF (14,300 kc., T9), ZB1R (14,330 kc., T9), K7EWZ and VR4AD VE6HR reports good Asian and African DX on the low-frequency side of 20, the best including XU9MK (14,096 kc.), XU8RB ('phone), VS2AK ('phone), VU2FV (14,100 kc.), XZ2DY ('phone and c.w.), XZ2DX (14,040 kc., 'phone), PK3MP (14,050 kc.), and a large number of South Africans W2IOP reports EL2A (14,380 kc.) on again, VQ8AA (14,056 kc.), CN8MI (14,280 kc.) and CR7AT (14,400 kc.) W6NPU out in Utah contributes XU8MY (14,360 kc., T6) and CR7AK (14,350 kc., T9x) W8ACY worked FB8AA (28,020 kc.) Latest at W8LZK include VQ4CRO (14,090 kc.), ZE1JI (14,375 kc.), VU2LK, VU2FV, VU2AU and VU2DR. Mac says that VU2GJ (14,128 kc.), whom a number of the boys call "VU2OJ," wants a sked with South America, for WAC, and some W6 and W7 QSO's.

A group of the more serious 56-Mc. lads are continually trying to crack that band for some real DX. The latest confirmed report we have of DX on 5 is from VK5ZU, who was heard by ZL4DQ on March 13. The distance is 1800 miles, and VK5ZU was only using 18 watts to a final doubler stage. There are many more fellows plugging away with c.c. c.w. on the band, and every once in a while they break through for some DX. If you do work over 1500 miles or so on 5, please let us know.

What:

We were away on a short trip last month, and out around Pittsburgh we had a nice meeting with some of the DX gang at W8KWA's house. W8JMP, W8OSL, W8DWV, W8IQB, W8PT and W8BSF were there, and for about two hours we had a swell bull session. Just like every other DX bunch, these fellows complain about their poor locations and stuff, but they really knock off the DX. A couple of them have been experimenting with half-wave vertical doublets with ground screens underneath them to minimize the ground losses, and they seem to be getting good results. They told us that W8DWV has about half the copper in the country buried in his yard!

From there we went out to W8CRA's shack for a visit. Going out there is, of course, like taking a pilgrimage to Mecca as far as any DX-minded ham is concerned. Frank has a little shack on the side of a really high hill just outside Cannonsburg, and you get the impression that from there you could throw a rock into most of the foreign countries, if the wind were right. The rig is very straightforward, and ends up with an HK-354 in the final. The antenna is Frank's old standby that he's used for a long time, a 133' end-fed antenna which has been pruned down to exactly the right length, so that when it's clipped on to the final tank it doesn't change the tuning one bit. When he QSY's to the low end of 20 he inserts a length of wire to make up the difference. Frank says that he's able to run his tube cooler at the same input by having the wire just the right length. The receiver is a superhet with two stages of r.f. and one i.f. stage, and is very smooth-working as you would expect.

The visit confirmed one thing. The lads who rate as the top DX men in the world are fellows who have confidence in their gear and then set to work familiarizing themselves with every signal on the band. Fellows like W8CRA don't waste time listening to the wrong signals because they recognize practically all of them before the station signs, and they seem to have an intuition that tells them how long and where to call. They've put in plenty of hours gaining this faculty, and it pays dividends. So if you want to get up there in a DX way, forget about your rig and resign yourself to putting in some time operating. You'll find it pays off. (And don't think Frank told us this; he's about the most modest and unassuming fellow we've ever met.)

Who:

W6GHU, who was VQ2FJ's first W contact, says that the Rhodesian station uses 12 watts to a 10. Ray also reports VQ4KTF (14,075 kc.) and VQ4CRO W9RCQ sends in a swell letter, and tells that his countries are now up to 95. Bill got a boot out of relaying some RSCG news from VP2AT (who had missed the mail boat) directly to G6WY (who edits that section of the Bulletin), five hours



KENNETH LUM KING, K6BAZ, AND CLYDE deVINNA, W6OJ

Ken doesn't always dress like that; he was working as an extra in "The Good Earth" at the time the picture was taken. K6BAZ is now at Howland Island and has been furnishing a number of the boys with their first QSO with the island. The rig he uses now is 70 watts to a 211 final but the signal really raps into the States. A 4-wave length Vec is the answer.

after getting it from 2AT. Which proves that ham radio can still beat the mails a trifle! A batch of cards came through recently from VQ8AS at Chagos, after a lot of us had given up on him. Paul writes to explain that the mail boat only touches Chagos three times a year, and that he QSL's, but naturally with some delay. He has received several complaints and letters written in an unpleasant manner, which strikes us as being tops in poor taste K4KD says that someone is bootlegging his call and giving his old address at Ensenada W8OSL sends in a few for the "Brag Column," as he calls it: U5KN (14,380 kc.) and VS7RA (14,165 kc., T9). Whaddya mean, "Brag Column"? We've been thinking of calling it the "Pardonable Pride and Possibly Plausible Department" W2AAL put up a new beam for Asia and been smoking right through there. He points out that J2OV is a real Prince, which adds another member of royalty to the amateur ranks. AAL gives the QTH of U9BK as Ost Jakowoguesk, but can't find it on the map W9EF worked VR6AY for his 101st country W8MHH struggles

along with only a 3 1/4-wave onnaside diamond, flat-top beam, and a Vee, for antennas. Gosh, that's tough W6JMR is still concentrating on Europeans out there, and mentions that SM4XX (14,060 kc., T9) is the only active SM4. Wally has worked over 500 different Europeans, which sounds mighty good W8QQE, whom you may remember worked WAC in 14 days after receiving his license, worked 73 countries in his first year on the air W8HGA is one who hasn't moved up into the high-power brackets, and so his 92 countries worked with a pair of '10's is a pretty good record Dr. Malcolm, XU3MA, who is 77 years young, has the real stuff that makes radio amateurs. Recently the cable from Chefoo to Shanghai was cut, and for a month all of the commercial traffic was handled by XU3MA and XU8DI in Shanghai. Almost 500 messages were handled and, although the work was naturally arduous at times, Dr. Malcolm refused the \$300 that was offered him for his help. XU3MA works DX on 14,020 kc. . . . W5VV certainly has his troubles, according to W5VV. He has 121 countries now, but can't seem to wangle cards out of enough of them. But he's not kidding us. Heck, all we had to do was rub one of our QSL cards across Wilmer's signature and it got a reply from a station we'd almost given up hope on. Yes sir, it's almost unbelievable K7FBE, on 20 'phone, has three Vee beams that seem to do the trick for him. He has made WAC four times, and keeps skeads with F8XT and F18AC W5ACA passes along the dope that YR5CF is looking for New Mexico for WAS, and that from midnight to 3 A.M. seems to be a good time for African and European QSO's from that part of the country When we dashed through the Contest story last month we inadvertently credited W8LEC with using a HF200 in his final instead of the T200 he actually uses. No, this isn't an ad; LEC says the boys (who know what he uses) are kidding him about selling out to the commercials. Sorry, it's our fault Congratulations and best wishes to I1QR, who took the fatal step in April W9WCE passes along the fact that ZS1AH (14,375 kc.) wants New Mexico for WAS. Midnight, C.S.T. . . . W8OXO doesn't go for this guff about DX stations not being good rag-chewers, and nominates CT1ZZ, PY2FY, CR7AC, HA1P, CT3AB, HA7P, VK2OE, CE2BU, G8GB, CN8MS, G8UT, K5AB, G5LY, K5AN, YV5AK, LU4BH, VK8CA, ZS1AH, K8KMV and ZS2AC, as fellows that can and will fling chin with you W2IOP always pops up with stuff. This time he wonders if VE4ADT, whose name is Gray and QTH Little Red River Post, QSL via Fort Vermilion, is color blind. (No, but he's probably well read!) YV5AK is building up a pretty good record as a DX station. First YV WAC on 'phone, he has worked 63 countries and has a number of "firsts" to his credit VE5HR tells us that VE5GA runs grid-leak modulation to a pair of 46's in the final with less than 25 watts input, but has worked Europe and VK's with the thing W2GTZ has worked 129 countries; W2HHF has worked 110 and heard 149 W6MX does it the hard way. He has cards from stuff like VS7RP, YM4AA, SV1RX, YL2CD, SUIWM and XZ2DY but none from K4, VO, and TI Both G6WY and VK5LG suggest that some of these W's who complain that they don't get cards try sending an envelope to their QSL Manager. Most of the foreign stations, especially in the larger countries, are using the QSL services exclusively We're grateful to W6OTP for the following gem:

"Here's a tip from me to you:
For more DX use less CQ."

—W1JPE

DX Century Club

NINE more Century Club certificates have been issued since the last QST listings. The new members are W6HX, W8JMP, W8OSL, G6CL, W8LEC, W7AMX, W8DHC, W6KIP and W1DF. All but three of these moved up from the "75-or-more" group. W6KIP, W7AMX and W8DHC are listed this month for the first time. W1TW is now leading the United States club members by a narrow margin! G6WY maintains his hold on top position.

The Century Club and "75-or-more" listings represent the only official confirmed "countries worked" list in existence. There is no guesswork about the records indicated—confirmations have been presented and checked. Check over your confirmations in accordance with the January QST list of countries and send them in as soon as you can present 75-or-more. When sending your confirmations, please accompany them with a list of claimed countries and stations representing each country to aid in checking and for future reference after your confirmations have been returned to you. Please send postage to cover the return of the confirmations. The DX Contest should help many increase their totals. If the fellows you worked send in logs, we'll check same for confirmations, provided you have sufficient additional confirmations to make the total 75-or-over.

MEMBERS, DX CENTURY CLUB

	Countries
H. A. Maxwell Whyte, G6WY (No. 5)	130
Jefferson Borden IV, W1TW (No. 3)	121
Frank Lucas, W8CRA (No. 1)	120
John Hunter, G2ZQ (No. 6)	120
Clark C. Rodimon, W1SZ (No. 7)	118
Douglas H. Borden, W1BUX (No. 2)	115
C. E. Stuart, W6GRL (No. 15)	114
Henry Y. Sasaki, W6CXW (No. 4)	112
Don H. Mix, W1TS (No. 9)	111
Reeve O. Strock, W2GTZ (No. 12)	110
Harry G. Burnett, W1LZ (No. 10)	109
Walton H. Bostwick, W2GW (No. 11)	108
Jean Lips, HB9J (No. 13)	106
Onne L. Santii, W8DHC (No. 27)	104
Keat Crockett Jr., W9KG (No. 16)	103
Arthur H. Bean, W7AMX (No. 26)	103
John Marshall, W9ARL (No. 18)	102
Guy Grossin, F8RJ (No. 8)	101
E. L. Walker, W8DFH (No. 14)	101
Francis J. Walczak, W8DWV (No. 17)	101
C. L. Williams, W8JMP (No. 22)	101
Julius Wengler, W8OSL (No. 23)	101
W. H. Alexander, W6KIP (No. 28)	101
George Grammer, W1DF (No. 29)	101
H. Hodgins, E1SF (No. 19)	100
B. W. Benning, W4CBY (No. 20)	100
Fred M. Gillett, W6HX (No. 21)	100
Jack Clarricoats, G6CL (No. 24)	100
Richard J. Cotton, W8LEC (No. 25)	100

The following have submitted proof of contacts with 75-or-more countries:

W9PST 97	W5VV 89	W4CFD 81
PAØXF 97	W3BES 88	W8CJJ 81
W3EJVW 96	VK5WR 88	W1PTR 80
W1ZB 95	W3JM 87	W3A1U 80
W2UK 95	W6ADP 87	W3BVN 80
W2GT 94	W8EUY 87	W3EPR 80
W5BB 94	W9AEH 87	W8ADG 80
W8OQF 94	W6GAL 86	W8DGP 80
W9KA 94	G2DZ 86	W4BFD 79
PAØQF 94	W1RY 85	W3EPV 78
W6FZL 93	W4DRD 85	W8FJN 78
W9EF 93	W2HHF 84	W9FLH 78
F8RR 93	W8BOX 84	W1BFT 77
W1CC 93	W8KKG 84	W6ITH 77
W1DUK 92	W4AJX 83	W8BSF 77
W1WV 92	W6BAM 83	W9UAM 77
W9ADN 92	G5QY 83	FB8AB 77
W1ZI 91	PAØQZ 83	W1EWD 76
W1JPE 90	VE2EE 83	G5BD 76
W3EVT 90	G8GH 82	SU1WM 76
G5RV 90	W2CYS 81	W1BGY 76
W2GVZ 89	W4CCH 81	W5ASG 75

O.B.S.

The following is a supplement to the list of A.R.R.L. Official Broadcasting Stations in October QST (page 50): W1IOT, W1KON, W3AOT, W8IBR.

Briefs

From the latest Nevada S.C.M. report we pass along a little dope for the benefit of stations needing Nevada for W.A.S. W6MVP on 7 and 3.5 Mc. will schedule anyone for W.A.S. contact, W6BYR is on 14 Mc. with a rotary beam. Other active Nevada stations: W6CW, W6ONU, W6BIC, W6UO, W6FUO, W6FST and W6PTE.

There are now nearly 2400 active members of the Rag Chewers Club. The "Old Sock" notes with interest that one of the newer members is Joseph Sock, WILCHI W8PNJ reports Cincinnati R.C.C. members holding an over-the-air meeting the last Sunday of each month at 2:00 P.M. For longer and more interesting contacts watch for stations that sign "RCC."

Although Canada-U.S.A. Contest results are not complete at this writing, indications are that VE2EE is the leading VE participant and W6MVK highest scorer in the States. MVK worked 130 Canadian stations, 25% more than the leader last year.

April was W3EEW's lucky month. From April 1st to May 2nd he raised 71 stations out of 71 called—an even 100%. It couldn't go on forever, of course, and the lucky streak was broken when he missed a local 7001-kc. was the magic frequency.

On the night of March 28, 1938, VE3ZA answered a CQ from VE4LH. As the QSO got under way ZA had a recollection of working LH before. Examining his log he found that the previous QSO, his first with LH, had been on March 28, 1937, just one year before, to the day!

Some time ago Jim Thompson, W4DGS, Alabama S.C.M., met the sister of W4CJZ via amateur radio. Time marched on, signal strength increased, and on April 22d W4CJZ became W4DGS' brother-in-law. Congratulations to Mr. and Mrs. W4DGS!!

W5GO moved from Texas to New Jersey and found himself living two blocks from W2GO!

W1HIL's new junior operator is really "QRM"—he'll sign his QSL's "Quinten Russell Mitchell."

The W1KGR indicated in the cartoon on page 60, May QST, is now W8RGA.

The Newfoundland Amateur Radio Association will hold its annual Field Day on June 11th and 12th. The dates correspond with the dates of the A.R.R.L. Field Day. Watch for the VO portables.

More Re the Sweepstakes

Received too late for the May QST Sweepstakes report is word from VE3IR that he made 29,767 points, contacts with 204 stations in 49 sections. W4MS, Western Florida, and W8DST, Western New York, were erroneously listed as c.w. participants. They both used voice exclusively in the SS and are 'phone winners in their respective sections. W9GWK and W8BYM had a side bet on which would make the higher SS score. W8BYM won, and when W9GWK paid up recently BYM dropped us a card to say, "Here's how." (P.S. The bet was a can of beer.)

William Horton of Haines City, Florida, recently licensed, received a surprise when his ticket came through bearing call letters corresponding with the name of his mother's business, the F. H. & B. Insurance Agency. Horton is W4FHB!

About three years ago W3EFC (Every Penny Counts) attended a hamfest at Wilmington, Delaware, winning a

BRASS POUNDERS' LEAGUE

(March 16th-April 15th)

Call	Orig.	Del.	Rel.	Extra Del. Credit	Total
W4PL	20	46	1313	27	1406
W7WJ	181	49	782	18	1030
W6LUJ	119	211	423	204	957
W7DUE	10	12	868	22	912
W6IOX	65	116	608	115	904
W6AM*	438	422	42	—	902
W2CGG	24	28	810	17	879
W7EBQ	11	45	768	48	872
W8OFO	29	62	741	13	845
W6LMD	6	11	818	3	838
W2BCX**	9	3	803	—	814
W3SN	64	114	621	—	799
W6DH	56	135	456	133	780
W5EOE	20	100	632	16	768
W3BWT	171	115	406	63	755
W5FDR	74	156	392	104	726
W3BYR	14	8	678	5	705
W3CIZ	18	88	495	88	689
W5CFZ	38	136	480	26	680
W3EML	75	100	406	87	668
W9OUD	21	55	550	21	647
W8QGD	95	80	400	43	618
W9ESA	43	167	316	88	614
W6FYR	—	—	600	—	600
W6BMC	10	18	553	3	589
W6CDA	7	51	460	49	567
W2EEL	92	196	142	136	566
W8NUV	14	47	420	24	565
W1HOT	73	71	401	11	556
W7FVK	11	14	512	6	542
W9DLM	537	—	—	—	537
W2BCX	3	3	515	—	521
W2JHB	16	116	262	121	515
W3EDC	12	97	386	18	513
W6HT*	52	121	205	105	513
W4DWB	6	114	338	53	509
W9DI	15	23	455	10	503
W6ZX	60	135	215	92	502

MORE-THAN-ONE-OPERATOR STATIONS

Call	Orig.	Del.	Rel.	Extra Del. Credit	Total
W5OW	133	115	1040	32	1370
W8BNT	48	208	720	56	1032
W1GJO	29	71	438	45	583
W4AWO	26	62	372	62	522

These stations "make" the B.P.L. with total of 500 or over. One hundred deliveries+Ex. Del. Credits also rate B.P.L. standing. The following one-operator stations make the B.P.L. on deliveries. Deliveries count!

W6CZO, 335	W2HOZ, 169	W6HSA, 116
W1UE, 258	W2GVZ, 140	W1KH, 114
W6CIT, 250	W5ZM, 136	W7APS, 114
W6IMI, 249	W9KJY, 132	W9MRQ, 106
W3QP, 212	W6GMC, 129	W8NLL, 103
W6MIS, 204	W6RQI, 123	W3GFC, 101
W6JTV, 196	W2BGO, 122	More-than-one-opr.
W6KFC, 196	W9NVF, 121	W5FPO, 188
W5GFT, 182	W2DBQ, 119	W5FSK, 115

A.A.R.S.

Call	Orig.	Del.	Rel.	Extra Del. Credit	Total
WLMI (W6GXMI)	83	134	652	122	991
WLNf (W2BCX)**	12	2	515	—	529

MORE-THAN-ONE-OPERATOR STATIONS

Call	Orig.	Del.	Rel.	Extra Del. Credit	Total
WLM (W3CXL)	198	186	3351	64	3799

A total of 500 or more, or 100 deliveries Ex. D. Cr. will put you in line for a place in the B.P.L.

* All traffic handled by two-way radiotelephone.

** February 16-March 15.

Patterson PR-12 receiver. At the 1937 Hudson Division Convention he won the main prize, a Sargent "21." And at the Union County Amateur Radio Association's hamfest in Newark, N. J., in April, '38 he drew an RME-69! At Wilmington his ticket number was 079, at the Hudson convention the Bingo No. 79 won the receiver for him, while at Newark ticket No. 179 did the trick. Some fellows have all the luck!! Hi.

W7FSH reminds us that it's a good idea to list our call letters and complete address with the local post office to enable them to deliver QSL's addressed only to the call and town.

Hams Afloat

WIJTI and WIJMS are on the U.S.S. *Mugford* . . . W8RN is operating KFMK (S.S. *Pioneer*) on the Great Lakes . . . Frank C. Blauvelt, ex-W9EMH, would like his old ham friends to know that he is now employed on a Merchant Marine vessel, the S.S. *Azalea City*, operating from the Gulf and East Coast into Europe . . . W7GFK is RM3C in the Coast Guard and is pounding brass aboard the Cutter *Onondaga* stationed at Astoria, Oregon . . . W6LAP is an operator on the U.S.S. *Lexington* . . . VE3ABW is second operator on the S.S. *Cavina*, running between Bristol, England and Kingston, Jamaica . . . "Gil," W1CJD, QST cartoonist, is now operator on KDBD, S.S. *Pastores* of the United Fruit Company . . . W5GLO is "Sparks" on KUJT, running between Tampa and New Orleans weekly . . . W4DPG is operator on the *Diezle Sword*, KOCP . . . WSCEU has been assigned to the S.S. *Wandotte*, WADR, for the summer . . . J. A. Thomson, operator on the S.S. *Pennsylvania*, is considering a 23-Mc. portable-mobile installation for the ham bands . . . On the S.S. *Alleghany*, KFGA, are ex-3JA as Chief Operator, W3BJK, Second Opr, and W3FEE, Third Opr . . .

The *Ad Astra*, 32-foot auxiliary cutter, was due to leave Wilmington, Calif., April 10th, on a two-year world cruise, with Capt. and Mrs. William J. Zaleski and Gene Carron aboard. She carries 734 feet of canvas, a 25 horsepower auxiliary engine, gasoline for 700 miles, 165 gallons of fresh water and weeks of canned and dry provisions. A short-wave radio installation operates under the call WPVW. Schedules are to be maintained with W6NSN, Long Beach. Honolulu is the first stop, then to the Gilbert and Solomon Islands, Australia, Sumatra, India, Arabia, Egypt, the Mediterranean, Madeira Islands, the Canaries, Verdes and Leeward Islands, Panama, Galapagos and home.

The Indiana Radio Guard, an outcome of previous flood communication experience, is being organized by Lt. W. E. Brown of the Indiana Adjutant General's office. A 3.9-Mc. 'Phone Net for the I.R.G. is drilled each Thursday at 7:00 P.M. CST with W9AKI as control station. Other net stations are W9HBS, WWI, RE, AJX, MUR, CLF, HBD, JUA, EXC, BDE and JZA.

Radio amateur employees of the International Business Machines Corporation have organized the IBM Radio Experimenters' Club and hope to have a club station. Members are on the lookout for company employees all over the world. At the Endicott, N. Y., plant are the following amateurs: W8CHJ DEQ NSF GZQ QZK QZX HFK ARH CVB and EFK.

W1GKJ's first W7 QSO on 'phone, completing contacts with all districts on 'phone, was with W7GKJ on 28 Mc.!

W4DDB, De Land, Fla., was called on 14-Mc. 'phone by W4FHV of the same city with the request that he assist in getting an important message into New York City. This was at 8:09 P.M. W4DDB's "CQ NYC" brought a reply from W2KDY, Brooklyn, with whom contact was established at 8:35 P.M. It took until 8:50 to get the message through, due to conditions, but W2KDY then made delivery by telephone and at 8:55 transmitted a reply to W4DDB, who relayed to W4FHV. The sender of the original message was in W4FHV's shack and sent another message, which traveled the same route. The work was concluded at 9:05 when W2KDY and W4DDB signed.

ELECTION NOTICES

To all A.R.R.L. Members residing in the Sections listed below: (The list gives the Sections, closing date for receipt of nominating petitions for Section Manager, the name of the present incumbent and the date of expiration of his term of office.) This notice supersedes previous notices.

In cases where no valid nominating petitions have been received from A.R.R.L. members residing in the different Sections in response to our previous notices, the closing dates for receipt of nominating petitions are set ahead to the dates given here-with. In the absence of nominating petitions from Members of a Section, the incumbent continues to hold his official position and carry on the work of the Section subject, of course, to the filing of proper nominating petitions and the holding of an election by ballot or as may be necessary. Petitions must be in West Hartford on or before noon of the dates specified.

Due to resignations in the Iowa, Oregon and Hawaii Sections, nominating petitions are hereby solicited for the office of Section Communications Manager in these Sections, and the closing date for receipt of nominations at A.R.R.L. Headquarters is herewith specified as noon, Wednesday, June 15, 1938.

Section	Closing Date	Present SCM	Present Term of Office Ends
Utah-Wyoming	June 1, 1938	Townsend J. Rigby	June 15, 1938
Iowa	June 15, 1938	Owen Williams (resigned)
Hawaii	June 15, 1938	Otis Hill (resigned)
Oregon	June 15, 1938	Eugene E. Lovejoy (resigned)
Ca.-Cuba-I. of P.-P.R.-V.I.	June 15, 1938	Bannie L. Stewart	Dec. 14, 1936
Maritime*	June 15, 1938	Arthur M. Crowell	June 14, 1937
Nevada	June 15, 1938	Edward W. Heim	June 14, 1937
Vermont	June 15, 1938	Alvin H. Battison	Apr. 15, 1938
So. Minnesota	June 15, 1938	Webster F. Soules	Apr. 16, 1938
Los Angeles	June 15, 1938	Don M. Draper	July 1, 1938
Illinois	July 1, 1938	L. John Huntton	July 10, 1938
Santa Clara Valley	Aug. 1, 1938	Eibert J. Amarantes	Aug. 15, 1938
Ohio	Aug. 1, 1938	E. H. Gibbs	Aug. 17, 1938
Nebraska	Aug. 1, 1938	S. C. Wallace	Aug. 17, 1938
Western Mass.	Aug. 1, 1938	William J. Barrett	Aug. 17, 1938
New Hampshire	Aug. 15, 1938	Carl B. Evans	Sept. 1, 1938

* In Canadian Sections nominating petitions for Section Managers must be addressed to Canadian General Manager, Alex Reid, 169 Logan Ave., St. Lambert, Quebec. To be valid such petitions must be filed with him on or before the closing dates named.

1. You are hereby notified that an election for an A.R.R.L. Section Communications Manager for the next two year term of office is about to be held in each of these Sections in accordance with the provisions of the By-Laws.

2. The elections will take place in the different Sections immediately after the closing date for receipt of nominating petitions as given opposite the different Sections. The Ballots mailed from Headquarters will list in alphabetical sequence the names of all eligible candidates nominated for the position by A.R.R.L. members residing in the Sections concerned. Ballots will be mailed to members as of the closing dates specified above, for receipt of nominating petitions.

3. Nominating petitions from the Sections named are hereby solicited. Five or more A.R.R.L. members residing in any Section have the privilege of nominating any member of the League as candidate for Section Manager. The following form for nomination is suggested:

(Place and date)
Communications Manager, A.R.R.L.
38 La Salle Road, West Hartford, Conn.
We, the undersigned members of the A.R.R.L. residing in the Section of the Division hereby nominate as candidate for Section Communications Manager for this Section for the next two-year term of office.

(Five or more signatures of A.R.R.L. members are required.)
The candidates and five or more signers must be League members in good standing or the petition will be thrown out as invalid. Each candidate must have been a licensed amateur operator for at least two years and similarly, a member of the League for at least one continuous year, immediately prior to his nomination or the petition will likewise be invalidated. The complete name, address, and station call of the candidate should be included. All such petitions must be filed at the headquarters office of the League in West Hartford, Conn., by noon of the closing date given for receipt of nominating petitions. There is no limit to the number of petitions that may be filed, but no members shall sign more than one.

4. Members are urged to take initiative immediately, filing petitions for the officials for each Section listed above. This is your opportunity to put the man of your choice in office to carry on the work of the organization in your Section.

—P. E. Handy, Communications Manager

ELECTION RESULTS

Valid petitions nominating a single candidate as Section Manager were filed in a number of Sections, as provided in our Constitution and By-Laws, electing the following officials, the term of office starting on the date given.

Alabama	James F. Thompson, W4DGS	April 15, 1938
Kentucky	Darrell A. Downard, W9ARU	April 15, 1938
Washington	W. Beale, W7FCG	April 15, 1938
Saskatchewan	Arthur Chesworth, VE5AY	April 22, 1938
South Dakota	Dr. A. L. Russell, W9VOD	May 18, 1938

Station Activities on page 84



CORRESPONDENCE

The Publishers of QST assume no responsibility for statements made herein by correspondents

Motor QRM

Box 536, Montgomery, W. Va.

Editor, QST:

... We all are well aware that small appliances, such as vacuum cleaners, kitchen mixers, sewing machines, electric razors, and other similar items cause the greater part of the background noise which every ham and B.C.L. listener has to contend with, and that in some locations it gets to be plenty loud. Now, my idea is this: Ask the manufacturers of these devices (and all others which might cause noise) to start equipping their appliances at the factory with filters to keep the noise off the power lines. I know that this seems like a large order, and it is, but if it could be done I'm sure that in a few years we could begin to notice quite a difference in the noise level. At the present time the various types of electric razors seem to create more racket for their size than anything else, and as they are selling quite rapidly the manufacturers should be contacted and asked to do something about it. I would think that the cost of adding built-in filters to any of the offending appliances would be very small, and I don't think that any purchaser would object to any slight increase in price due to the addition of the filters. Even if the manufacturers had to bear the cost of the filters, I would think that the increase in good will would more than offset the slight cost. I came across a case the other day which proves, as Edgar Guest says, "It can be done." A friend of my wife's had purchased a pair of electric scissors, a product of Singer, and I was looking at them and thought, "Here's some more line noise," but on plugging the appliance into a socket and turning it on, with the radio operating, I was greatly surprised to find that it did not cause any noise at all. Their sewing machine was also a Singer and I tried the motor on it to see if it caused any noise, but none was noticeable. It seems to me if Singer can build small motors that are not noise producers, others can also.

I believe a campaign to reduce this class of noise would have the support of most of the B.C.L. listeners as well as the hams, and if it became necessary they could write to their congressman to try to bring about the required result by law.

—J. C. Craver, WSOBZ

EDITOR'S NOTE.—We happen to know that at least one electric razor manufacturer will pay a

mighty comfortable sum to any ham who can devise a universally effective filter which can be incorporated in the razor. Here is a chance to benefit mankind and yourself as well! So far as the larger motors are concerned, ham missionary work in recommending the purchase only of adequately filtered devices can unquestionably be of value if sufficiently concerted action can be had.

For Approved Receivers

Marshalltown, Iowa

Editor, QST:

I read the letter in the Correspondence section by Lynn Faulkner entitled "Gyp B.C.L. sets and QRM," and wish to comment that at last I believe someone has hit the nail on the head as to how this complaint situation about amateur QRM can be helped.

No need for me to say anything as to the method, as he has it all there. I do wish to say, though, that as a service man I would welcome the system of "approved receivers" by some method of government standard such as the Underwriter's, in order that the public might not expect the impossible from the service man on some of these sets.

It would not only help the hams, of whose ranks I am one, but also the radio-set business as a whole.

I would like to see the League get behind this proposal and push it to the extent of getting something of the sort started, and I believe that the legitimate set manufacturer would be behind the movement as well.

—Chauncy Hoover, W9KWY

Television from the British Angle

EDITOR'S NOTE.—We were fully resolved to terminate the television controversy in QST, feeling it had already been given the space proportionate to its importance, when this letter arrived. Presenting as it does a slant based on experience rather than conjecture, however, we felt justified in reopening the subject to the extent of permitting this voice from abroad to be heard.

3, Summer Ave., East Molesey, Surrey, England
Editor, QST:

I have read with considerable interest the arguments put up by W2GTW, W2HYC and W2DQW, etc., on one hand and W3GKI,

W4BIA and W3OYW on the other, re the attitude to take as a ham in respect to this new side of radio technic.

I feel that neither side of your "argumentists" have the right idea, although there is a lot to be said for each. It did seem to me that the American manufacturers were trying to exploit the hams, and I cannot see quite where the glory is coming in for the ham. I am employed on the production staff of the largest television company in England, and can say this, that our British manufacturers have sunk thousands of pounds in their own research and developments, without the outside help of the experimenting public.

The fact that a few hams are employed by the various companies is incidental. They, the manufacturers, have progressed through the stages of research, development and production, and this not only with receivers but in actual transmission systems, which do function.

These give reliable day-to-day television service to a large area of viewers. This has been the case since August, 1936, when the television service started from the B.B.C. station at Alexander Palace, North London. This is not an experimental service but a thoroughgoing everyday occurrence, and the scope of transmitted matter is extremely wide, especially now that the outside transmitting vans are going.

Only this last week-end I was able to "see" the Oxford and Cambridge boat race via television. Visits have been paid to film studios within thirty or forty miles of London and scenes transmitted from them by the OV vans and re-transmitted by the main station. Besides this, plays, cabarets, news films and topical interviews with the day's important people are only a small part of the everyday transmissions. Last summer I had the pleasure of seeing the American tennis stars playing from the Wimbledon Tennis Arena.

To get back to my point, this has been done by the British manufacturers without the going out for outside help, and for their initiative and foresight we take our hats off to them. Therefore I think W2GTW has a little in his argument, but he is altogether wrong in claiming to be anti-television. Television is here and it is up to us to foster it, but at the same time to do so in a way that there is no mistake. It is either for personal amusement and satisfaction or to acquire the knowledge of the new technic to further one's position in the commercial world.

On the other side, I don't advise the lads to stork around with puffed-out chests and think of what they are going to do for television. If your manufacturers have the same in them as ours, then they'll get down to it themselves and, with their equipment, do it better than hams can hope to do it. Don't think I am writing as if our British hams are doing nothing, for it is surprising the number employed in the radio trade and B.B.C., but nevertheless television in this country has been brought to the very successful stage it is by the joint co-operation of the British manufacturers, the B.B.C. and the British government.

—Leslie Cooper, G5LC

Hams and Tremors

Lenoir City, Tenn.

Editor, *QST*:

A slight earthquake tremor striking this town at about 4:10 A.M. caused me to think in more ways than one. . . . Of course amateur radio is always looking out for something to do in the way of message handling, particularly in flood and relief work during emergency. Really, that is about the only excuse for the existence of ham radio. But this little quake of Old Mother Earth gave me an idea which I hope will find some interest along with message and ordinary traffic handling. It seems to me that, among the thousands of hams all over the country, quite a few would be interested in geology . . . interested enough to construct some simple seismographs for recording earth shocks. Possibly we could get some support from Washington along this line. . . . While of course the government has several very delicate instruments and stations about the country, there are several large areas that have none at all. For instance, in all east Tennessee there is none. Therefore it certainly seems to

me that a number of amateurs scattered over wide areas would be very helpful in locating geological faults with the possible clearing up of several such mysteries. My idea would be to have such recordings as may be made by amateurs reported, perhaps weekly, through amateur net channels, to headquarters, thereby allowing such information as may be obtained to be available for maps. I think that this field should become very interesting, possibly more so than stamp collecting or amateur astronomy. Certainly we could by this means use our amateur radio for a good scientific purpose.

—Dr. Roy R. Campbell, W4DFR

Logic

808 Grosvenor Ave., Winnipeg, Canada

Editor, *QST*:

The other night a few of us were riding around looking for something to do, so we thought we'd drop in on a fellow ham whose sig we had often heard but whom we had never met. In due course we arrived and were ushered downstairs to the radio shack. A sign on the door greeted us with: "Amateur Experimental Radio Station ———." We entered.

There on the operating desk we beheld the following first-class equipment: manufactured transmitter, manufactured receiver, bug, mike, etc. We were proudly informed that out in the back yard was a newly-added piece of equipment, namely, a manufactured directive array. We then asked for the dope on the transmitter, and got the shock of our lives when it was apparent that the operator didn't even know the functions of the various tubes! After the usual ham talk we left.

That was our introduction to "Amateur Experimental Radio Station ———." What was amateur about it? Where was the experimenting done? Will that type of station justify "amateur" occupation of frequencies so avidly desired by commercial stations?

There may be some good reasons for hams using commercially available equipment, and I don't expect we should make such parts as transformers, resistors, etc. Not that we couldn't make many of them, as witness the amazing story printed in *QST* of the ham who did so, and under the extreme handicap of blindness. Maybe we can't make a transmitter or a receiver as good as we can buy—and maybe we can! In any case I fail to see how a man can take pride in the "robot-working" of equipment he had no part in making and which, in some cases, he does not understand. Couldn't he get just as much pleasure out of using the telephone? It is a marvelous piece of equipment, and he could be proud of it, and make more useful friendships with people living within a few miles—might get a job or a wife out of it, too! For DX he could put in a transatlantic call to Europe.

We all know that amateur radio trains operators available for war time, provides stations strategically located in times of national disaster, is a stepping-stone to radio as a career, and even has made some technical contributions to the science. However, the more we hams must buy our stations ready made, proceed to get on 'phone, be "big broadcasters," forget the code, have no emergency apparatus—in short, fail to justify our occupation of the bands, the sooner the governments will turn our frequencies over to the commercials.

—Frank Coughlin, VE4NM

QSL Matters

Acton House, Felton, Northumberland, England

Editor, *QST*:

The letter written by CPIAA which appeared in March 1938 *QST*, headed "QSL Troubles," has encouraged me to write about the same subject.

I have always sent a QSL card to any station QSO'd during the 10½ years I have been on the air. In every case my QSL card has been sent direct, or else to the various QSL bureaus (three cards in an envelope, to save postage expenses). If there are any U.S.A. stations who have QSO'd

(Continued on page 56)



Early in June every year, it is the custom for that branch of the radio industry which includes amateur communication equipment to gather in Chicago for the Trade Show. There the manufacturers can get together in conference with their dealers from all over the country and discuss with them the planned changes in their lines for the coming season. At this time, it is generally customary to display advance samples of all the new items to be added to the various manufacturers' lines during the coming season, and

to issue advance specification sheets, photographs, etc., so that those dealers and mail order houses who issue catalogs will have some material to work with during the summer when of necessity they have to prepare their Fall catalogs.

This year, we are adding more new products to our line than for some years past. Our development laboratory has grown considerably during the past year, and we have a number of new parts items, as well as additions and changes to our receiver line. Then, of course, there are the new transmitting items, such as the NTE combination speech amplifier-exciter unit, the NSA speech amplifier, and the foundation units for final stages, power supplies, modulators, etc. On these some preliminary announcement has already been made in the advertising pages of the last two issues of *QST*.

All rumor to the contrary notwithstanding, there is to be no change in our HRO. We have from time to time since this receiver was first placed on the market made minor mechanical and circuit revisions. For instance, we found the nickel finish on the main tuning dial of the original production not to be quite as lasting as we felt proper. Consequently, we changed to the enamel finish. The push buttons on the original "S" meter control have been superseded by switches and so on. Nothing radical — just steady improvements — but as a result the HRO is still the finest receiver we know how to build, and consequently, it is not possible for us to supersede it with something else.

The NC-101X strictly amateur band receiver is being changed so as to replace the "cat's eye" with an HRO type "S" meter. This will be standard equipment in the future at no extra charge. The NC-100 and NC-100X are also being changed mechanically. The chassis remain exactly as they have been in the past but they are now being mounted in a higher cabinet with a new type illuminated dial. The dial is directly calibrated in frequency, and in addition, there is a continuous running vernier dial giving band spread readings graduated from 0 to 1000 at all frequencies. As in the NC-101X, the "cat's eye" is being replaced with an "S" meter. Anyone having one of the present model NC-100s or NC-100Xs, who wants the new cabinet, dial and "S" meter installed on his receiver, may have the work done at a net price of \$25.00, f.o.b. our laboratory by arrangement with the dealer from whom the receiver was originally purchased.

In the way of entirely new receivers, we are making an addition to the line in the very low-priced field; — but of that, more next month.

JAMES MILLEN



It POUNDS Into Service Problems Like a Ton of Bricks

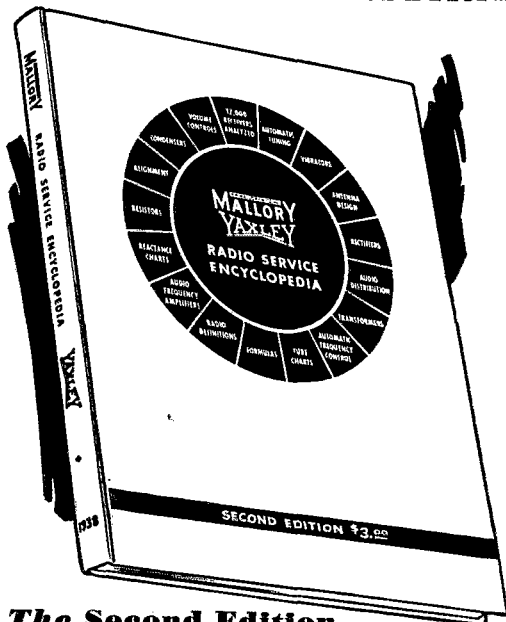

The Second Edition **MALLORY-YAXLEY** Radio Service Encyclopedia

Radio amateurs and experimenters will welcome this great book because of its simple exposition of the principles of 1938 radio receiver design. No hunk—but complete information written so you can understand it.

Twice the information contained in the First Edition . . . 17,000 receivers analyzed (5000 more than the First Edition) . . . the right answer to every service problem . . . in one book . . . on one page . . . on one line.

All that's New . . . Automatic Tuning, for example

All the dope on Automatic Tuning . . . with over 100 illustrations . . . schematics . . . trouble-shooting charts . . . for every system. The low down on Audio Degeneration . . . the inside on Alignment . . . complete new Tube Charts . . . covering every type and make. Mallory-Yaxley spent thousands of dollars to make this Second Edition the greatest time saver a radio service man ever had. But the cost to you is so low you'll pay for it with the time you save on one job. Sign off on lost time and low profits today. See your distributor. His supply is limited.

P. R. MALLORY & CO., Inc.
INDIANAPOLIS INDIANA
Cable Address—PELMALLO

Use
P. R. MALLORY & CO. INC.
MALLORY
APPROVED RADIO
PRECISION PRODUCTS

Use
YAXLEY
APPROVED RADIO
PRECISION PRODUCTS

Correspondence Dept.

(Continued from page 64)

G6YL and received no card, I advise them to apply to their district QSL manager.

From May 1931 to the end of 1937 there are QSL cards owing to me from 81 U.S.A. stations whom I have worked, and to whom I have sent my QSL. No doubt W/G QSOs are not considered DX by the QRO gang, but as the input at my station has never exceeded 6 to 10 watts I am always glad to have QSL cards to confirm QSOs. Up to date the number of U.S.A. stations from whom I have received no QSLs are as follows: W1 (25) W2 (18) W3 (8) W4 (2) W5 (1) W6 (10) W7 (2) W8 (9) W9 (8).

During QSO they all assured me they would QSL! Maybe they did so, but the cards have never reached me, either via R.S.G.B., or direct. Perhaps this letter may jog their memories. Here's hoping!

—Barbara Dunn, G6YL

Apartado 952, San Jose de Costa Rica

Editor, *QST*:

I am writing you with the hope that you will find some interest in those lines for the U.S.A. amateurs.

It is very hard to send 432 QSLs to U.S.A. and only receive 35. I am on the 20-meter 'phone band since two months ago. It is very discouraging to send so many QSLs and receive only a few. In view of this I had decided not to send any more cards to U.S.A. until I get from there first.

Many amateurs in South America are doing the same thing, and in the next future the American hams will not receive a single QSL until they send it first. . . .

H. Perez B., TI8HP

Sign Your License

53 East 7th St., Holland, Mich.

Editor, *QST*:

Just a word regarding the signing of operator's licenses. Many amateurs when receiving their operator's license or having their license renewed fail to sign their names on the dotted line on the operator's side. Until the operator signs his name to the license it is void. . . .

—Rus Sakers, WDED

Resonant Filters Again

6 Woodland Pl., White Plains, N. Y.

Editor, *QST*:

In working over the 40-meter band I notice many amateur stations are changing over to resonant filter. The majority of these stations do not properly adjust these filters and as a consequence have developed an illegal broadly modulated note. This type of emission is now causing an unwarranted amount of unnecessary QRM.

Because of its current popularity the writer believes some drastic steps should be taken to abolish this type of note on the ham bands. If all stations used it I am sure there would be so much QRM that no one would be able to work out successfully.

On account of its relatively cheap cost the high-power stations are the ones installing it, which makes matters worse.

It is my suggestion that A.R.R.L. print an article describing the proper adjustment of this type of filter or discourage its use entirely. I do not think any ham has the right to the use of a commercial width channel in the ham bands, and I believe my complaint is absolutely justified.

—R. H. Sweeney, W2FEQ

EDITOR'S NOTE.—Readers are referred to the correspondence and editor's comment on this subject in the August 1936 issue of *QST*.

Let's Use Our Beans

91 Marion St., Brookline, Mass.

Editor, *QST*:

It is evident that conditions on all bands have changed radically since the first of the year, particularly on the 14-Mc. band. The skip has shortened on 14 Mc. so that here on

(Continued on page 64)



**WHAT'S NEW
IN HAM GEAR?**

**LET'S GO TO THE
TRADE SHOW
AND FIND OUT**

On the Program

**35,000 Sq. Ft. of Displays —
Parts, Receivers, Transmitters,
Meters, Mikes, Crystals, Tools,
Gadgets.**

**Demonstration of Facsimile Apparatus —
Friday Evening, June 10, under Auspices of
I.R.E.**

*Amateur Day
Saturday, June 11*

**Movies of Pitcairn Island —
Saturday, June 11. (Subject to
arrival of films from the
Island.)**

**Lecture on the DuMont Phas-
majector (Television) Saturday
Evening, June 11, under Aus-
pices of the R.S.A.**

Take a tip — make the trip to the 1938 National Radio Parts Trade Show at Radio Parts City, Stevens Hotel, Chicago, June 8, 9, 10, 11. Get the "dope" on all the latest developments in Ham gear, in parts and complete receivers and transmitters. Meet and talk with Manufacturers and their Engineers, with Jobbers and Amateurs — from all parts of the country — from all parts of the world. And have a good time doing it, too!

It's the only National Radio Parts Trade Show of the year — a complete Radio Parts City in itself. So, pick up and Go. Don't let anything stop you. Ask your Jobber, or cut out the coupon now, paste on a Post Card and drop it in the mail for your Advance Registration. Our Personal Service Bureau will be glad to make all the arrangements for you.

*Sponsored by Radio Manufacturers Association
and Sales Managers Club*

**National Radio Parts
Trade Show**

*Radio Parts City, Stevens Hotel, Chicago
Wed., Thurs., Fri., Sat., June 8, 9, 10, 11, 1938*

National Radio Parts Trade Show
Personal Service Bureau
53 W. Jackson Blvd., Chicago, Ill.
Please send Advance Registration Blank. I am a
 RADIO AMATEUR _____
Name _____
Address _____
City _____ State _____

d i v e r s i t y r e c e p t i o n f o r t h e a m a t e u r

the skyrider *Diversity*

Model DD-1

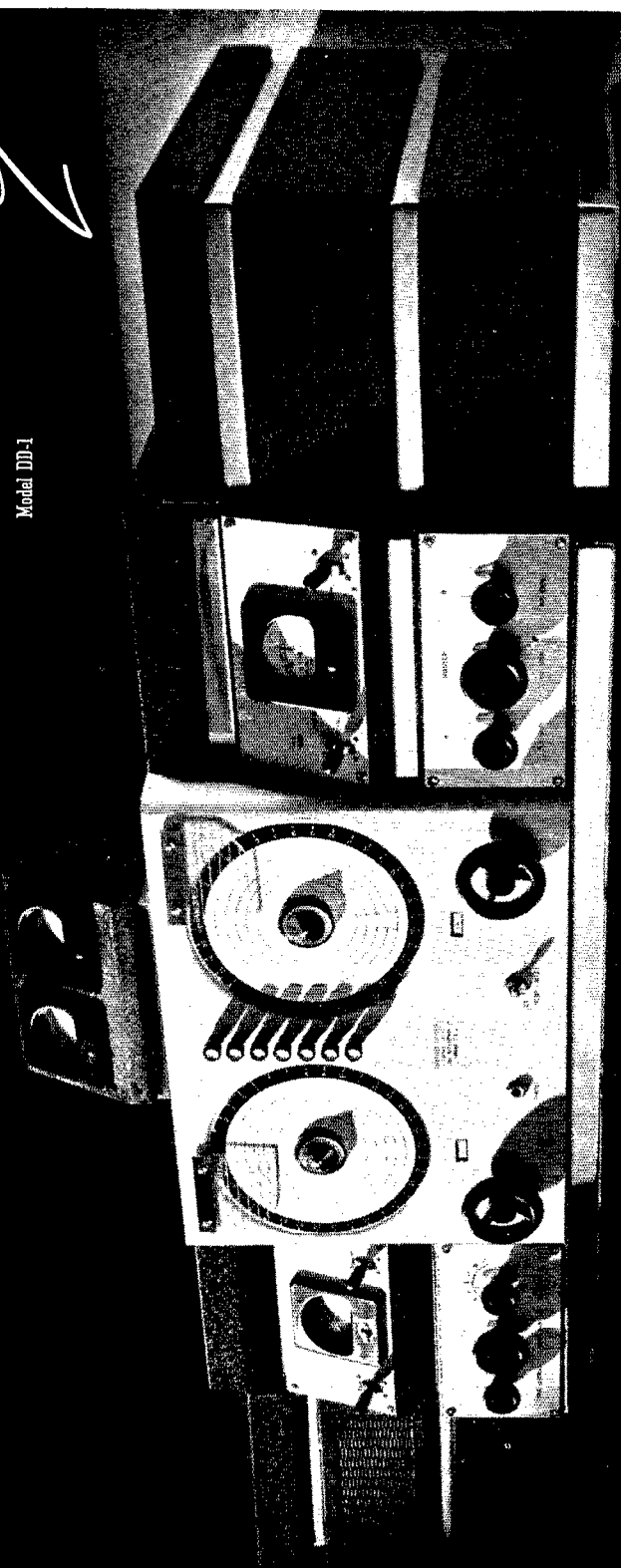

A Dual Diversity Receiving System

Readers of QST are familiar with the work on Diversity Reception by Mr. James I. Lamb and Mr. J. L. A. McLaughlin*, and that of Mr. McLaughlin and Mr. Karl W. Miles** more recently reported in these pages.

The SKYRIDER DIVERSITY represents the culmination of several years' work by these engineers.

The principal advantages of Diversity Reception, as exemplified by this Dual Diversity Receiving System, may be summed up as follows:

1. The reduction of fading to negligible proportions.
2. An increase of signal strength over that of any single receiver.
3. Improvement of signal-to-noise ratio over any single receiver.
4. Reduction of heterodyne beat note interference.

To bring the SKYRIDER DIVERSITY to a high standard of electrical and mechanical perfection, with strict adherence to the principles of functional design, the Hallicrafters went outside their own organization to such specialists in their respective fields as Mallory, Aladdin, Raytheon, Crowe, Stancor, Aerovox and Jensen.

Their collaboration, with the original work of the engineers already mentioned, has enabled the Hallicrafters to offer the advantages of Diversity Reception for the first time, in easily operable form, and at a price within reach of the amateur. See the NEW SKYRIDER DIVERSITY at your dealer's today!

*QST May, 1956

**QST November, December, 1957

All Hallicrafters Receivers Available on Liberal Time Payments

the hallicrafters inc.

2611 INDIANA AVENUE, CHICAGO • CABLE ADDRESS: HALLCRAFT, CHICAGO

World's largest builders of amateur communications receivers

The SKYRIDER DIVERSITY, A Dual Diversity Receiving System

the NEW hallicrafters skyrider diversity

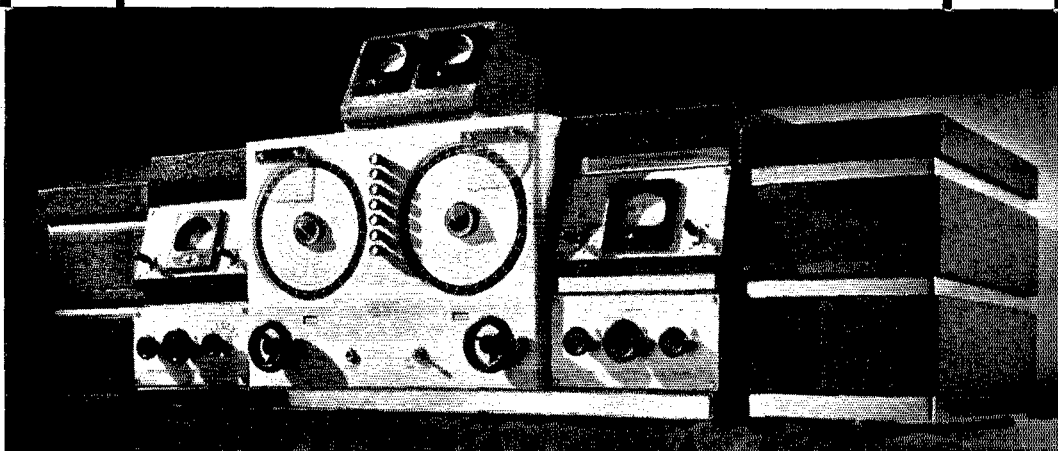

with **Dials and Driving Mechanisms**
by **CROWE**

CROWE PRODUCTS

- *Metal Dial Plates*
- *Chromium Dial Plates*
- *Tuning Units*
- *Instruments Dial*
- *Control Name Plates*
- *Bakelite Knobs*

*for amateur receivers and
transmitters*

Congratulations to the Hallicrafters on the SKYRIDER DIVERSITY! This Dual Diversity Receiving System represents a tremendous advance in amateur radio reception, and the Crowe organization is gratified that it could play its part in bringing this revolutionary new receiver to amateur radio.

Only an organization with the facilities and resources of Crowe could produce dials and driving mechanisms of the required precision for this advanced receiver. Crowe, like Hallicrafters, is always working for the advancement of radio and is the logical source of supply for radio mechanisms of advanced design and superior quality.

CROWE NAME PLATE & MFG. CO.

3701 North Ravenswood Avenue, Chicago, Illinois

Cable Address: CRONAME—Chicago

the hallicrafters inc.

The SKYRIDER DIVERSITY, A Dual Diversity Receiving System



ALADDIN POLYIRON I. F. TRANSFORMERS

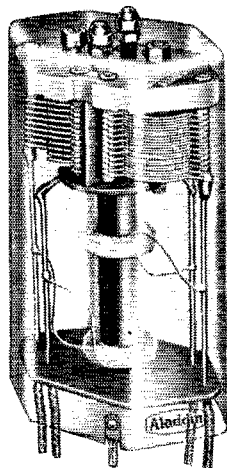

Contribute to the
Remarkable Selectivity and Sensitivity
of the new hallicrafters

"sky rider diversity"

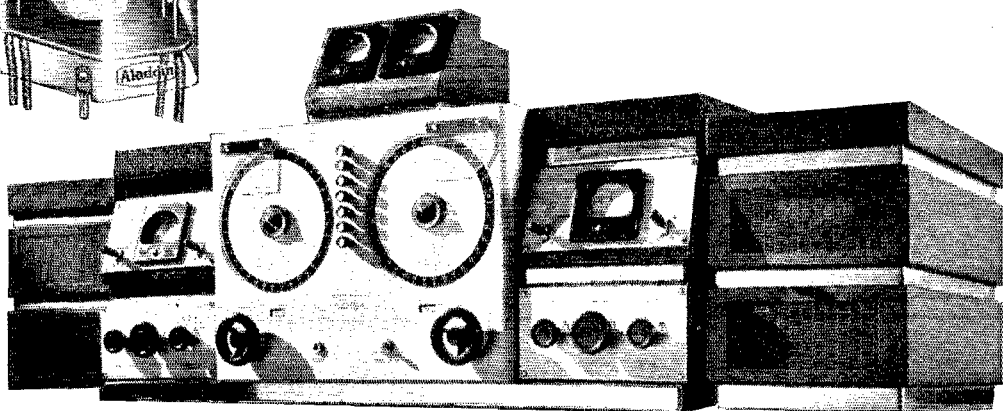

The ALADDIN "Modernistic" Polyiron I.F. Transformers selected for the Sky rider Diversity receiver are designed to Hallicrafters' exacting specifications. A remarkable degree of rejection of off-channel signals is achieved, enabling you to eliminate objectionable interference and providing exceptional SELECTIVITY and SENSITIVITY without the use of an I.F. crystal filter circuit. The new ALLADIN air trimmer has three point support for the stator insuring greater stability. Withstands extremes in temperature

and humidity. The rotor contact uses a special pigtail connection which insures a positive contact instead of the usual bearing connection which is subject to corrosion. The new method of capacity variation is definitely controllable; requires only 120° rotation and has special stops which identify minimum and maximum capacity. No guess work... no false peaks. The modernistic, streamlined shield is specially designed for more efficient operation and compact installation.

ALADDIN RADIO INDUSTRIES, INC.

Licensee of Johnson Laboratories, Inc.

466q W. Superior Street
Chicago, Illinois
U. S. A.



These devices manufactured in Chicago, U. S. A. under one or more of the following U. S. Letters Patent: 1,857,850 1,910,222 1,975,508 1,975,509 1,975,600 1,982,689 1,982,690 1,987,153 2,002,500 2,005,208 2,012,622 2,022,554 2,032,520 2,032,514 2,035,439 2,051,012 2,059,995 2,082,527 2,082,529 2,082,690 2,082,696 2,094,189 2,095,420 2,104,722 2,106,207 2,106,222 2,106,229 2,106,252 2,115,603
Other patents pending.

the hallicrafters inc.

Say You Saw It in QST — It Identifies You and Helps QST

The SKYRIDER DIVERSITY, A Dual Diversity Receiving System

AEROVOX CONDENSERS

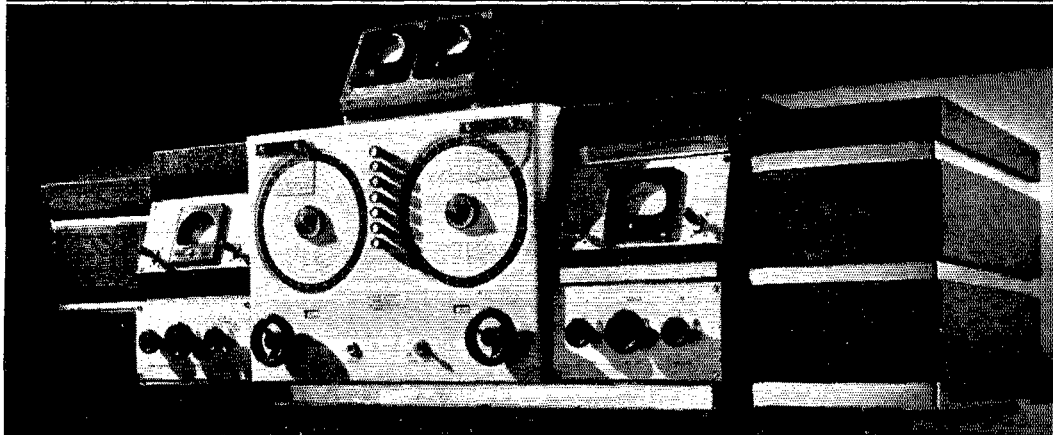

...are used in the hallicrafters
sky rider diversity

The New Dual Diversity Receiving System

An outstanding contribution to amateur radio, the new SKYRIDER DIVERSITY marks another milestone in radio reception. It is truly a masterpiece of advanced engineering and progressive design. Naturally, only the finest of parts were used in the construction of the SKYRIDER DIVERSITY and AEROVOX is justifiably proud that its Condensers were selected for this sensational new receiving system.

Contributing their stability and dependability to Hallicrafters advanced engineering, AEROVOX CONDENSERS help make the SKYRIDER DIVERSITY amateur radio's most advanced receiver!

Wet and Dry Electrolytics; Paper; Oil-Filled Transmitting; Wax-Filled Transmitting; Mica Transmitting; Padder Condensers; Exact Duplicate Replacements; Interference Filters; Auto Radio Condensers; and a complementary line of Resistors.



Each AEROVOX Condenser is designed and built to meet the most exacting electrical and mechanical requirements and is individually tested to insure satisfactory service under the operating conditions for which it is designed.

the hallicrafters inc.

Of Course,

STANCOR TRANSFORMERS WERE SELECTED FOR hallicrafters NEW skyrider diversity

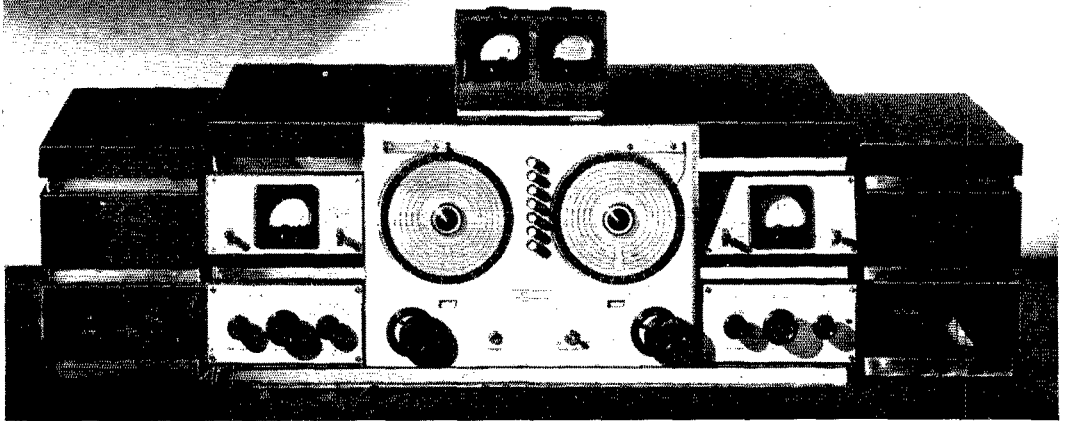

In this amazing new Dual Diversity Receiving System, the Hallicrafters have brought amateur radio reception to a new high standard of efficiency. Probably the finest, most advanced receiver available to the amateur today, it is a masterpiece of engineering, and Stancor is proud to have its transformers represented among the highest quality parts used in SKYRIDER DIVERSITY. Hallicrafters engineers, like amateurs all over the country, know that Stancor Transformers add dependability and higher electrical efficiency to the performance of their equipment.

These features determine Stancor supremacy

- 1 Cores of highest grade laminated silicon steel
- 2 Windings checked after each operation
- 3 Positive vacuum-impregnation with special equipment
- 4 Triple tested on dummy loads for perfect performance
- 5 The most modern factory in the industry



STANDARD TRANSFORMER CORP.
1500 No. Halsted Street, Chicago, Ill.

the hallicrafters inc.

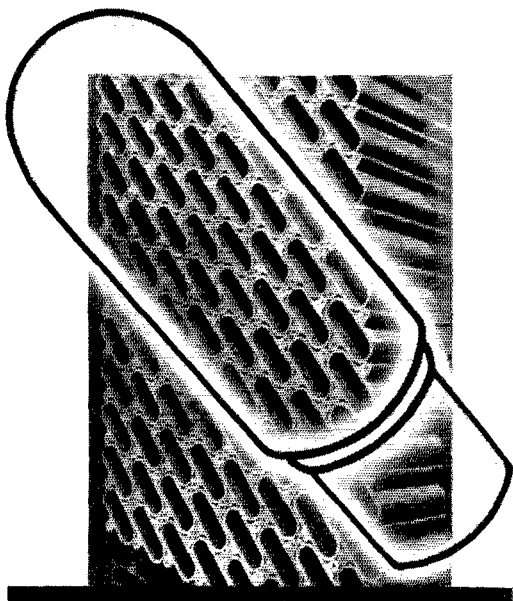

The anodes make the tube

Unless your transmitting tubes have SPEER Graphite Anodes, nothing else can make up for what you lose. Of all anode materials, only Graphite cannot melt, cannot even soften or warp, no matter how high the temperature. No other anode material even approaches Graphite in heat dissipation, radiation emissivity and thermal conductivity. Only SPEER Graphite Anodes bring you these advantages to the maximum extent. Their use by leading manufacturers insures better, more uniform tubes with greater power and longer life.

SPEER Graphite Anodes are sold only to tube manufacturers. Write for list and Anode Booklet No. 80.

SPEER CARBON CO.

ST. MARYS  PENNA.

NEW YORK CHICAGO MILWAUKEE DETROIT PITTSBURGH CLEVELAND

Ⓢ 8368

Correspondence Dept.

(Continued from page 56)

the east coast we now hear the stations in the 3rd, 8th and 9th districts with tremendous volume. One effect of this has been to increase the QRM proportionately with the result that the DX stations have become very difficult to pick out from the many more W stations we are hearing. Such a situation is undoubtedly affecting the middle west stations to an even greater degree, receiving as they do W signals from all directions.

So much for the situation. What can we do to remedy it? Realizing that the 14-Mc. band is now our only remaining good DX band, I have more or less restricted my use of this band to working DX and done my rag-chewing elsewhere. It would help the situation materially if more of us did this, but it goes further than this. Observation shows that a very large proportion of the QRM comes from needless testing, key diddling and meter gazing. A little thought could stop these practices. Don't touch that key with your antenna connected until you are ready to actually call someone. Do your testing and tuning up with a dummy antenna. That last tenth of an ampere in your antenna won't change your report the slightest, believe it or not. Just listen to the G's getting over here with ten watts input and think it over.

I am assuming that we all want to make contacts. This business of testing, making long calls, long CQ's, and other sloppy operating practices are all working against making those contacts. Let's use our beans and cut out this stuff.

—Miles W. Weeks, W1WV

Who Has the T9 Sig?

39 West 84th St., New York City

Editor, QST:

. . . I am a new amateur and operate on 40 meters. I never call CQ but mostly listen in. I hear a fellow calling CQ. His note is T5. I say, "Here is some beginner," but when he signs he is an old timer with his call W2A—. Next I hear a very good note and fist and say to myself, "Here is an old timer," but to my surprise it is a W2H—, or in other words a newcomer. This is true in many cases. I think, in fact I know, that a newcomer is very careful about his note because he wants to create a good impression and an old timer thinks it's too boring to check his signal and just puts it on the air. . . .

—Bruce T. McCoun, W2HWS

Alphabet Soup

270 Broadway, New York, N. Y.

Editor, QST:

Your worthy magazine is undoubtedly of great value to dyed-in-the-wool radio amateurs, which I am not. Personally, I find it too full of alphabet-soup to understand. If it were not printed in English the number of Q's would make it a real Chinese puzzle to me. My monthly gleanings to date have been about three paragraphs, outside of the editorial page, that I can read and understand. I sometimes feel a pang of envy for the fellow who has been sufficiently inoculated to master the alphabetology of amateur radio, but as I have neither the time nor the perseverance required to learn another language I have become resigned to leaving the field (and magazine) to those familiar with its verbiage.

My opening sentence is not a cutting remark to sever our relations but is based upon my observations of the real amateur (of whom I know one or two) in the presence of a copy of QST.

Best wishes for your continued success.

—A. L. Sprecker

Strays

W2HDC is the call of H. D. Cohen.

W2KBQ and W2KCC are brothers and have the same QTH.

W1EEQ and W1FOU of Manchester, Conn., both are named Wm. F. Johnson; and both

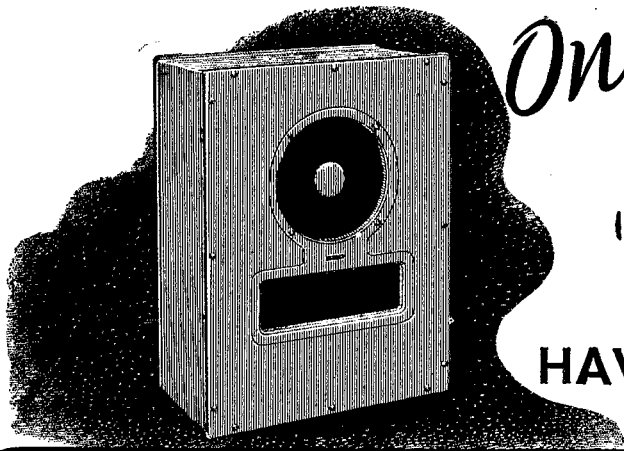

Only

Jensen Speakers

HAVE THE QUALITY
TO SUIT

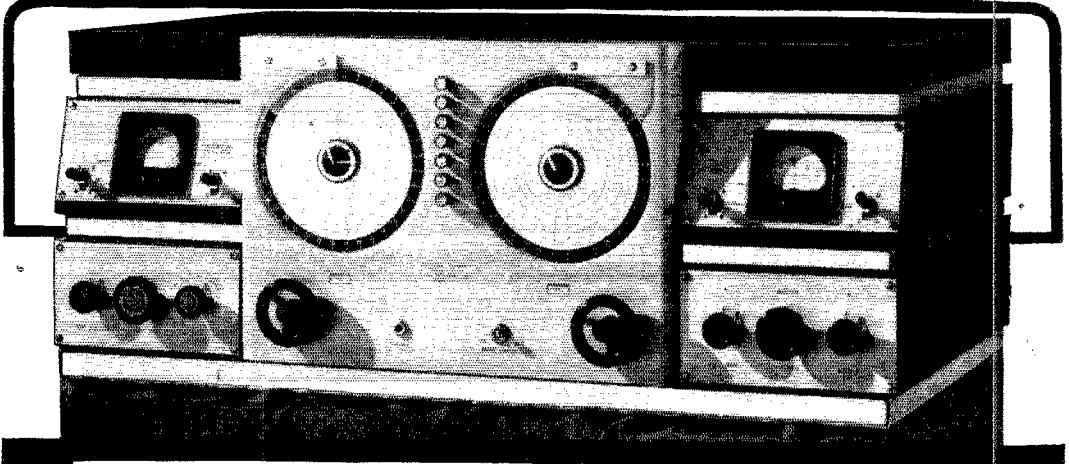

the new hallicrafter's **skyrider diversity**

Mr. W. J. Halligan, President of Hallicrafters, Inc., says —

"We consider the Jensen Peri-dynamic Reproducer with Bass Reflex to be the most capable equipment available today for the reproduction of sound. That is why in collaboration with Jensen Engineers we incorporated these advanced acoustic principles in the loud speaker system used with our new Skyrider Diversity."

Jensen Peri-dynamic Reproducers with Bass Reflex are available to the amateur in knock-down kit form for convenience and low cost and are in finely constructed and finished cabinets. All are available with 8, 10, 12, 15 and 18-inch speakers, and some with dual speakers. No baffle required. Write for Peri-dynamic folder.

A complete showing of Jensen Sound Reproducers will be exhibited at the Chicago Radio Parts Show. Visit us at Booths 202-204 Coulomb Street.

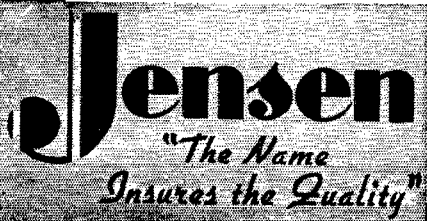

**JENSEN RADIO
MFG. CO.**

6601 S. Laramie Avenue
Chicago, Ill.

Q.S.T.-6-38

SPECIAL OFFER

a FREE three-month subscription to Sylvania News



The Sylvania News* is bound to prove helpful to you. Every issue is full of information — contains news of latest developments in radio . . . articles on important subjects . . . tips from experienced radio men. And a 4-page Technical Section — an extra feature — is especially useful to amateurs.

Take advantage of this offer — send the coupon today for your free, three-month subscription to Sylvania News.

*The official "house magazine" of Hygrade Sylvania Corporation. Also makers of the famous Hygrade Lamp Bulbs.

See us at 204-06 Ampere Ave., Nat'l. Radio Trade Show, Hotel Stevens, Chicago

SYLVANIA

Set-Tested Radio Tubes

HYGRADE SYLVANIA CORP. Q.S.T.-68 Emporium, Pa.

Please send me Sylvania News for the next three months free.

Name _____

Address _____

City _____ State _____

AMATEUR
 DEALER

SERVICEMAN
 EXPERIMENTER

Name of Jobber _____

formerly lived on the same street. FOU states that while he was waiting for his ticket, the RI asked why he wanted two calls in Manchester!

W1BEQ has auto tag VY73 and W1FEF has VY88 (among 1938 odd tag collections).

—W1KKS

Very often it is difficult to keep the backs of QST copies white with much handling. Lloyd G. LaBagh solves this problem by fastening a strip of transparent Scotch mending tape, one inch wide, over the back of each issue upon arrival. If the backs then become dirty, they may be cleaned with a damp cloth. The use of the tape also prevents the covers being torn off.

Regarding the construction of 9ZYB, a manufacturer's bulletin has, "In an endeavor to design a full KW transmitter that would show an amateur or 'phone operator just what is going on at all times, . . ." W1TS wonders why a 'phone man couldn't be an amateur, too!

Fourth A.R.R.L. Copying Bee

(Continued from page 37)

W2KMS W3FE-W9ZFC W9YRS W8DUA
W8IDX-W8QKM-VE5ABI W2EIG-W2KKR-
W4EOP W1JKT-W2IKK-W7BCT W5GDI-
W8OVH W7CWN-W8RIK W8GWY W8MKV
W3DXK W9SRL W1BDU W3OCC W7EPB
W1KRO W2GXK W2FCB R. O. Bronson
VE2FD W8QLW W2JK W2JGB W9YFJ
W9EPF W2GTA W7GAW W9KIK.

—E. L. B. & T. W. Y.

Hints and Kinks

(Continued from page 44)

parts must be available for the construction of the power supply.

Sockets for the rectifier tubes should be mounted on the chassis or on some piece of scrap metal (to avoid marring the metal chassis with holes which may be found useless). Then, with a connection made between one of the rectifier-plate taps on the transformer and one end of the bleeder resistor, a lead from the other end of the bleeder should be connected to the metal base, and a lead from the other plate connection of the transformer secondary should be connected to each of the filament terminals (and to plate terminals, if any) of the rectifier socket. With each connection to a socket terminal, 110-volt a.c. connection must be made to the transformer primary. Care must be taken that the operator does not come near any of the transformer-secondary circuit connections, and in addition, that the wires are kept well apart and well away from metal tables, pipes, or other wires.

Similar tests may be conducted with the filter chokes, connecting the ground wire to the frames or mounting feet and the other wire (the one connected directly to the transformer secondary) to the winding terminals of the choke.

This test must not be attempted as a breakdown test of the filter condensers, though it may

CENTRALAB Ceramic Capacitor

HEAVY COPPER COATINGS MAKE TUBULAR CAPACITOR PLATES

CERAMIC DIELECTRIC FOR LOW POWER FACTOR. COMPOSITION ALLOWS COMPLETE CONTROL OF CAPACITANCE-TEMPERATURE COEFFICIENT

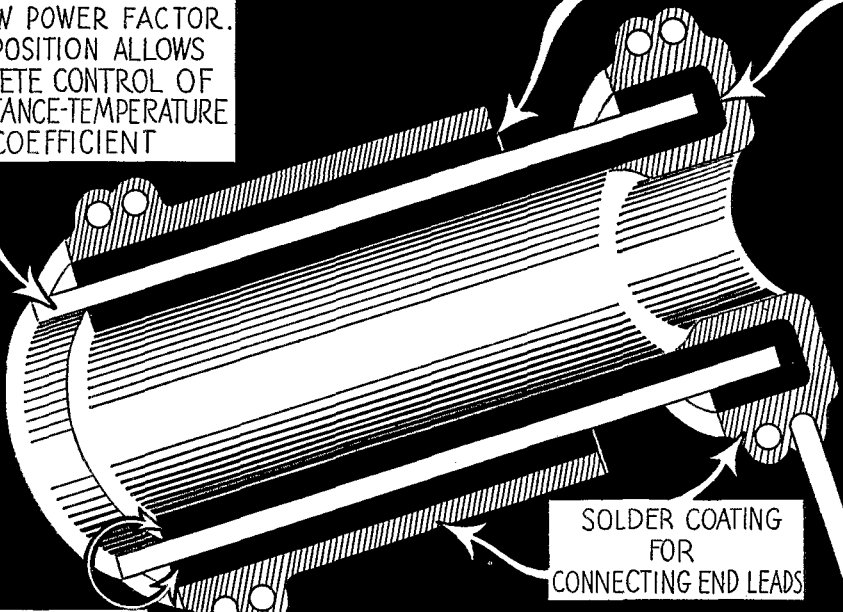

SOLDER COATING FOR CONNECTING END LEADS

ADEQUATE PROTECTION AGAINST BREAKDOWN AT 1000 Volts

CROSS SECTION OF A CERAMIC CAPACITOR

Introducing another member of the Centralab family

with the following characteristics and advantages:

- A single capacitor will provide any desired capacitance-temperature coefficient from 0 to a negative coefficient of .0007 mmfd. per mmfd. per degree centigrade.
- Ceramic dielectric has zero porosity. Capacity and power factor unaffected by aging or humidity.
- Low mass allows capacitor temperature to follow the chassis temperature closely.
- Capacitance remains constant at any frequency.
- Low power factor resin coating prevents moisture bridging between capacitor plates.

Manufacturers and set builders are invited to write our engineering department for more detailed data.

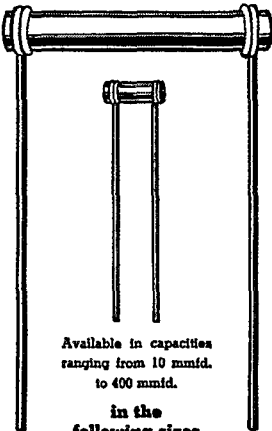

Available in capacities ranging from 10 mmfd. to 400 mmfd.

in the following sizes
 Type 818— $\frac{1}{4}$ x $1\frac{1}{4}$ inch
 Type 814 — $\frac{1}{4}$ x 1 inch
 Type 810— $\frac{1}{4}$ x $\frac{3}{4}$ inch
 Type 813— $\frac{1}{4}$ x $\frac{1}{2}$ inch

Centralab

CRL

Division of GLOBE-UNION INC., Milwaukee

**34,000 to 1
IMAGE RATIO!**

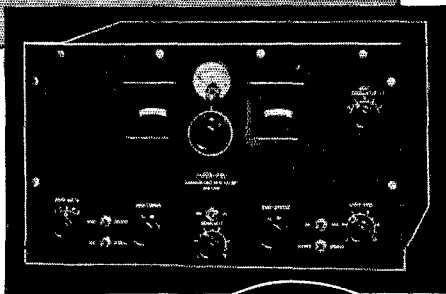

**Images are killed
in this precision
tuning unit**

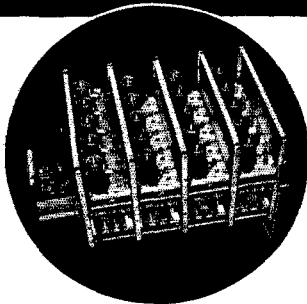

IMAGES have been successfully eliminated in the "Super-Pro." Owners report absolute image-free reception throughout the entire range of the receiver. The actual ratios of signal-to-image are 175,000 to 1 at 1 mc.; 65,000 to 1 at 2 mc.; 34,000 to 1 at 3.5 mc.; 10,000 to 1 at 7 mc.; 1,900 to 1 at 14 mc.; and 150 to 1 at 28 mc.

Images are killed in the precision tuning unit illustrated above. This assembly contains 20 tuned circuits (4 for each wave-band) designed for peak performance. Bands are changed with a special cam-operated noiseless knife switch. The tuning condensers, one four-gang and one twelve-gang band-spread, permit constant band-spread over the entire range of the receiver. With a 6 to 1 signal-to-noise ratio, the average sensitivity is .85 microvolt. Try a "Super-Pro" and note the difference!

WRITE FOR BULLETIN

HAMMARLUND MFG. CO., INC.
424-438 W. 33rd St., N. Y. C.

Q-6-38

Please mail me "Super-Pro" bulletin

Name.....

Address.....

City.....State.....



HAMMARLUND

Canadian Office: 41 WEST AVE., NO., HAMILTON, ONTARIO

well be used between the container of the condenser and the terminal of the condenser which will be operated above ground electrically—this test applies where the can of the condenser is not one of the condenser terminals, but instead, is supposed to be well insulated from both.

—T. M. F., Jr.

The Pentagrid as Second Detector

(Continued from page 51)

going, two points become apparent. Firstly it is seen that for the reception of c.w. nothing will be gained by the use of a high-value cathode resistor, since with these tubes direct rectification of the signal plays no part in the production of beats. On the contrary, the large bias resistor will run back the grid voltage, and in view of the variable-mu characteristics of this electrode, considerably reduce the gain. All that is required for c.w. reception is sufficient bias to avoid the signal's running the control grid into grid current and spoiling the selectivity and gain by damping the last i.f. transformer secondary. It should, however, be remembered that the signal at this point is a large one and that for this reason more bias is desirable than when using the tube for its normal function as a "first detector." An increase of bias resistor from the usual 300 ohms to some 1000 ohms is about right.

The second point that becomes apparent is that the failure to give good results on modulated signals in the absence of the b.f.o. is due to an inherent feature of the design of the tube. While a high cathode-bias resistor probably helps somewhat, the fact remains that such rectification that does take place is due to design defects and that no juggling with electrode voltages is likely to help much.

With this point grasped, the question is, what to do about it. The idea of using this type of tube as a combined b.f.o. is attractive, particularly in small receivers where space is at a premium. The answer is to switch to grid-leak detection when receiving modulated signals, retaining the standard arrangement for receiving c.w. The use of grid rectification causes some loss of selectivity due to the relatively low input impedance of this type of detector. On the other hand, the tube being of the screened grid type, the damping due to negative feed-back ("Miller effect") is nothing like so bad as it is in the case of a triode grid detector.

The revised circuit arrangement and constants are as shown in Fig. 3. Values of condenser and leak are conventional while the cathode bias resistor has a value of 600-1000 ohms derived as explained above. The bottom end of the grid leak is connected either to the cathode for grid rectification or to ground (thereby putting negative bias onto the grid) for the heterodyne reception of c.w. signals. The switch in question can conveniently be ganged with the on-off switch for the b.f.o.

The scheme is entirely satisfactory, gives very much better results than the arrangements used to date, and is strongly recommended.

GONE *the old fashioned
bulky, condenser*
HERE'S A BETTER WAY

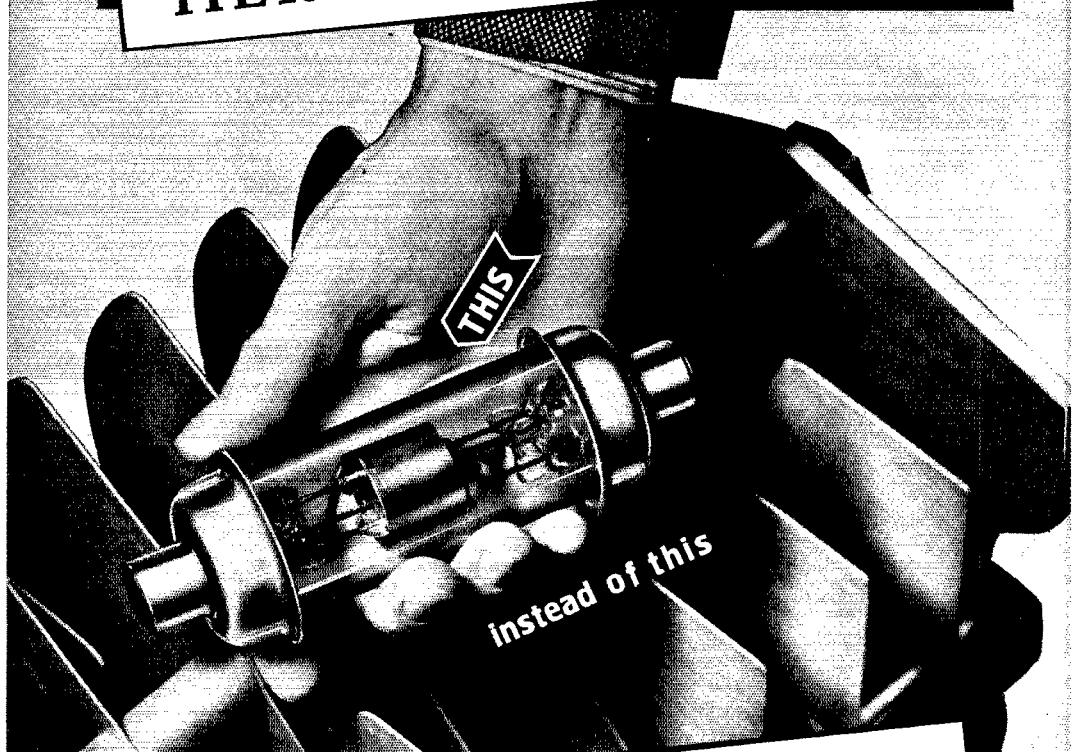

THE NEW EIMAC VACUUM Tank CONDENSER

So small you can hold it in the palm of your hand. This new tank condenser represents an important advancement in the technique of radio transmission. From now on . . . tank circuits need not be a limiting factor in high power operation.

The Eimac Vacuum Tank Condenser makes it possible, at last, to build a high power transmitter in a relay rack . . . a final amplifier for every band in one "rig." Whether for 50 watts or 50 kilowatts, this new condenser will revolutionize your transmitter. Optimum cir-

cuit efficiency is now possible at every frequency, from 100 megacycles to 100 kilocycles.

Amateurs! Broadcasters! Manufacturers! It will pay you to investigate at once. Your dealer has all available information . . . ASK ABOUT IT. If you have no dealer . . . WRITE!

Eimac
TUBES

EITEL-McCULLOUGH, INC. • SAN BRUNO, CALIFORNIA

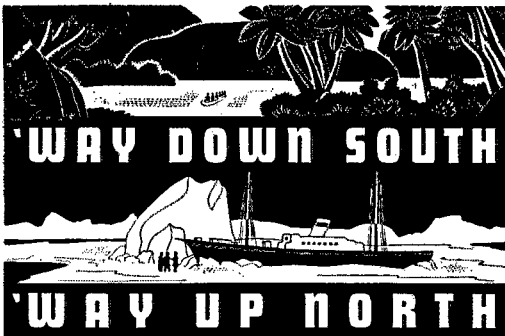

**Your Rig is Right with
OHMITE Resistance Units**

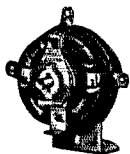

Ohmite Band Switch



Ohmite Rheostat



Ohmite Brown Devil



Ohmite Multivolt

From Pitcairn Island in the South Pacific to the Bowdoin Expedition in the Far North — from the sweltering heat and humidity of the tropics to the icy cold of arctic wastes — Ohmite parts stand the gaff — deliver the "goods" 24 hours a day every day! That's why Ohmite Vitreous-Enameled Resistors, Rheostats and Band Switches have been first choice on radio equipment for explorations, expeditions, and permanent installations at the outposts of civilization.

You can get this extra dependability in the Ohmite Vitreous-Enameled resistance units that your jobber stocks. They're the same units almost

universally used by nationally-known manufacturers of amateur and commercial radio transmitters and receivers. They're priced right, too!

See Your Jobber or Write for Catalog 17

OHMITE MANUFACTURING COMPANY
4831 W. Flourney Ave., Chicago, Ill., U.S.A.



Standard Frequency Transmissions

Date	Schedule	Station	Date	Schedule	Station
June 3	A	W9XAN	July 1	A	W9XAN
	B	W6XK		B	W6XK
June 10	A	W9XAN	July 8	A	W9XAN
	A	W6XK		A	W6XK
June 17	BB	W6XK	July 22	BB	W6XK
	A	W9XAN		A	W9XAN
June 18	BX	W6XK	July 23	BX	W6XK
June 19	C	W6XK	July 24	C	W6XK
June 24	A	W6XK	July 29	A	W6XK

STANDARD FREQUENCY SCHEDULES

Time (p.m.)	Sched. and Freq. (kc.)		Time (p.m.)	Sched. and Freq. (kc.)	
	A	B		BB	C
8:00	3500	7100	4:00	7000	14,000
8:08	3600	7100	4:08	7100	14,100
8:16	3700	7200	4:16	7200	14,200
8:24	3800	7300	4:24	7300	14,300
8:32	3900		4:32		14,400
8:40	4000				

Time (a.m.) Sched. and Freq. (kc.)

Time (a.m.)	Sched. and Freq. (kc.)
6:00	7000
6:08	7100
6:16	7200
6:24	7300

TRANSMITTING PROCEDURE

The time allotted to each transmission is 8 minutes divided as follows:

2 minutes—QST QST QST de (station call letters).

3 minutes—Characteristic letter of station followed by call letters and statement of frequency. The characteristic letter of W9XAN is "O"; and that of W6XK is "M."

1 minute—Statement of frequency in kilocycles and announcement of next frequency.

2 minutes—Time allowed to change to next frequency.

W9XAN: Elgin Observatory, Elgin National Watch Company, Elgin, Ill., Frank D. Urie in charge.

W6XK: Don Lee Broadcasting System, Los Angeles, Calif., Frank M. Kennedy in charge.

WWV Schedules

EACH Tuesday, Wednesday and Friday (except legal holidays), the National Bureau of Standards station, WWV, transmits with a power of 20 kw. on three carrier frequencies as follows: 10:00 to 11:30 A.M., E.S.T., on 5000 kc.; noon to 1:30 P.M., E.S.T., on 10,000 kc.; 2:00 to 3:30 P.M., E.S.T., on 20,000 kc. The Tuesday and Friday transmissions are unmodulated c.w. except for 1-second standard-time intervals consisting of short pulses with 1000-cycle modulation. On the Wednesday transmissions, the carrier is modulated 30% with a standard audio frequency of 1000 c.p.s. The standard musical pitch A=440 c.p.s. is also transmitted from 4:00 P.M. to 2:00 A.M., E.S.T., daily except Saturdays and Sundays, on a carrier frequency of 5000 kc., power 1 kw., 100% modulation. The accuracy of the frequencies of the WWV transmissions is better than 1 part in 5,000,000.

The One-Tube Receiver

(Continued from page 35)

determine whether condenser C_2 is effective in controlling regeneration. If it is impossible to receive any sound with the receiver, particularly during the evening hours, or if 'phone stations can be received but without any regenerative



NOISY VOLUME CONTROLS?

EVER hear of a life test? Well, a life test is where you try something out to see which will last longer, you or it. All progressive manufacturers keep part of their Engineering Department busy testing, and IRC is no exception. We have always devoted a large share of these studies to volume controls, for we know full well that there is room for improvement. When we compare our present product with controls of three or four years ago we feel pretty good, but we will never be satisfied. Our major premise is always: "A volume control is used to adjust the audio output of a circuit. It should not induce any noise of its own."

Various labors from time to time have brought forth the metallized resistance element, the five-finger kneec-action contactor, and now the spiral connection to the rotor arm. We will try to dissect the first two items for you this month.



The IRC resistance element consists of a bakelite base with a Metallized coating bonded to its surface. We use bakelite for the element because it does not absorb moisture like fiber or paper and is more stable. We apply the metallized resistance materials on the bakelite by an accurately controlled process. If the control is to have a linear curve, i.e.: a resistance increase directly proportional to rotation, we use only a single resistance material. If the control is tapered, i.e.: a resistance curve of varying slope, we use from 2 to 5 materials of different specific resistance. The important point is that all of these materials are

applied so that they blend nicely to make a quiet element. Our 15 years experience in applying resistance coatings is helpful here.

Once you have a good element, it must be securely mounted, both mechanically and electrically. We use only silver plated rivets for this important job.

Now, what is the best way to make contact to this resistance surface? There is one school of thought which contends that there should be no wiping action on the resistance strip, that this will wear the element out. In our opinion this theory is correct with regard to controls having soft carbon elements. Our metallized coating, however, is actually harder than the contactor. After "20 years service" on life test the element shows less wear than the metal contact fingers. So we use a wiping action here. Dust or grit is wiped out of the way by a moving contact; it is pressed into the element by a plain pressure contact.



The reason for 5 separate contact fingers is easy — each finger is independent of its neighbor, follows its own path, and adjusts itself, just like the kneec-action on your car, to any minute inequalities on the element. A single flat or "line" contact, either wiping or pressure type, can't do this; it only hits the high spots.

Take the cover off and examine the next control you buy. Your speech input amplifier deserves a good one.

Next month — the latest improvement in controls: a positive connection to the rotor arm.

INTERNATIONAL RESISTANCE COMPANY • 401 NORTH BROAD STREET, PHILADELPHIA, PA.

ADVERTISEMENT

Say You Saw It in *QST* — It Identifies You and Helps *QST*

**DOWN
COMES
THE
PRICE!**

**UP
GOES
THE
VALUE!**

ONLY
\$129⁵⁰
F. O. B.
Factory

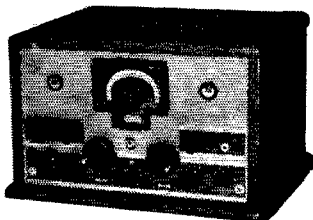

**FAMOUS MODEL ACR-111
AMATEUR COMMUNICATION RECEIVER
NOW YOURS AT NEW LOW COST!**

THIS De Luxe Amateur Communication Receiver was a swell value at its old price of \$189.50. But now, at this new low price, it's practically a super-value! Just look at its "years ahead" features—and you'll agree that it's the "buy of the year."

The ACR-111 employs *two* stages of *Pre-Selection*, a real *Noise Suppressor*, ultra-sharp *Crystal Filter*, fine *Electrical Band Spread*, useful *Tuning* and *Signal Input Indicator*, easy-to-read *Selector Dial* and *Sixteen RCA Tubes* to bring in the signals from 530—32,000 K. C. There are *More Features* you should know about.

For full details, see your nearest distributor or write to the address below. But by all means, do it soon—while the supply lasts at this bargain price.

For maximum performance at minimum cost
—use RCA Radio Tubes.

RCA presents the Magic Key every Sunday, 2
to 3 P. M., E. D. T. on the NBC Blue Network.

Ask your distributor or send 10c to Camden for a commemorative advertisement on RCA's television tube announcement.



**FOR
AMATEUR RADIO**

AMATEUR RADIO SECTION

A Service of the Radio Corporation of America
RCA Manufacturing Company, Inc., Camden, N. J.

"squeal," the cathode tap on the coil should be moved nearer the grid, or top end. If on the other hand, the signals are received but it is found impossible to stop the regenerative whistle by rotating C_3 , the tap should be moved nearer the ground end of the coil. Since phone signals are always received with the regeneration control at slightly lower capacity than the point at which the set goes into regeneration, and c.w. signals are always received with the condenser at slightly higher capacity than this point (except when very strong signals are being received), it is very desirable to have the set begin to whistle on a received station at a point near the middle of the capacity range of C_3 .

The coils are designed so that each amateur band is spread over a large part of the dial range. In order to set condenser C_1 to the proper position for coverage of a band, therefore, C_2 should first be set to minimum capacity (condenser open), and C_1 should be rotated from minimum capacity toward maximum until the high-frequency edge of the amateur band is reached. During hours of great activity for a desired band, no difficulty should be experienced in recognizing the change from commercial signals to those of amateur stations. When the position of C_1 corresponding to the high-frequency edge of the band is found, the condenser should be adjusted to a slightly lower capacity, in order that a small margin on each end of the band will be available on the tuning dial.

A suitable antenna length for this receiver is 50 feet, although other lengths may be used. It is important that the antenna for this type set be non-resonant on the amateur bands, for difficulty is otherwise experienced in holding the regeneration of the receiver at a fixed level. A resonant antenna does not make the use of the set impossible, but operation in the amateur bands is more convenient with an antenna resonant at points outside the bands. If it is desired to use an end-fed antenna which is designed for transmitting, the change-over switch should be connected to the receiver by a five- to ten-foot wire, so that the combination of the connector and the antenna proper will be tuned to lower frequencies than the amateur bands.

Despite the simplicity of the set, it is a highly satisfactory regenerative receiver of its type and the performance which may be obtained with reasonable care in construction more than justifies the small amount of time and effort required.

Gang Tuning for the Multi-Stage Transmitter

(Continued from page 11)

adjusted so that it is connected across a smaller portion of the coil. Each adjustment of the tap will have some effect upon the minimum capacity of the circuit so that each time an adjustment is made it will be necessary to return the tuning to the high-frequency end of the band and retune for this end of the band before again checking the low-frequency end.

Used by
Hams
WHO
KNOW

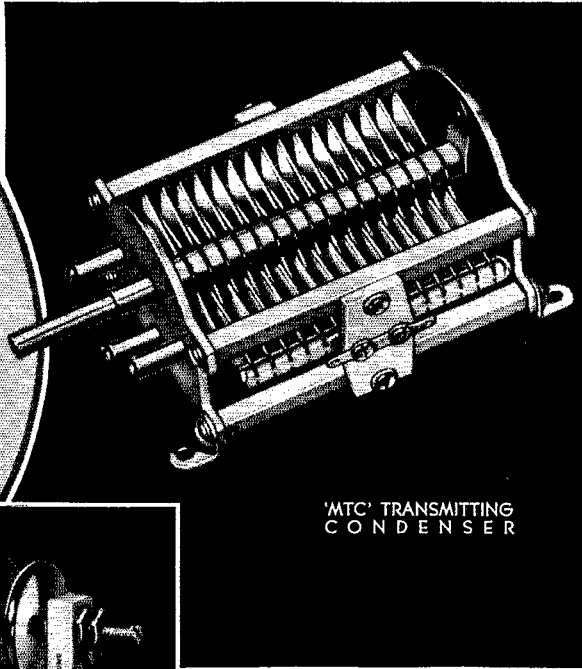

'MTC' TRANSMITTING
CONDENSER

Use "HF" micros in multi-band exciter units for best results. Available in all standard sizes.

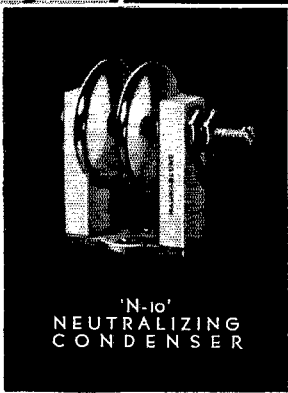

'N-10'
NEUTRALIZING
CONDENSER

"N-10" and "MTC" condensers are ideal for final amplifiers. Compact in size, they leave nothing to be desired.

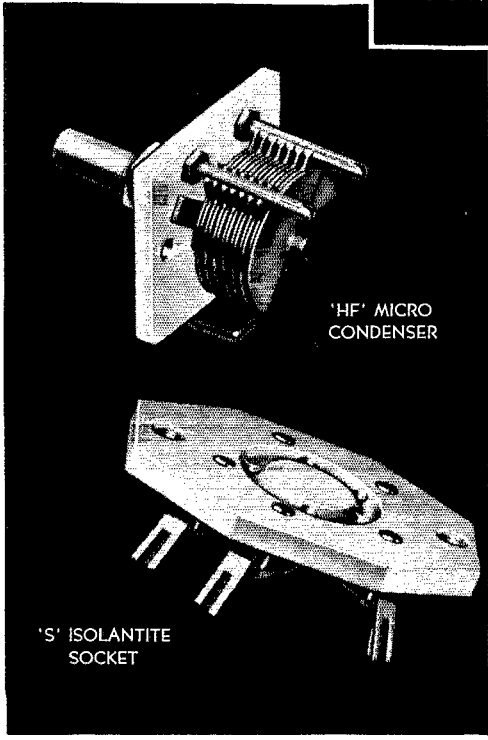

'HF' MICRO
CONDENSER

'S' ISOLANTITE
SOCKET

HAMMARLUND parts are used extensively by the "Old-Timer." He knows that precision parts mean consistent results. Whether you are building a low power "rig" or an "ether buster," use Hammarlund components and watch your DX list grow.

For multi-band exciter units, type "HF" micro condensers and type "S" Isolantite sockets are naturals. "MTC" medium size transmitting, and "N-10" neutralizing condensers are just right for that medium power amplifier.

Visit the Hammarlund exhibit at the Radio Parts Show in Chicago — send for catalog illustrating our complete line.

MAIL THIS COUPON!

HAMMARLUND MFG. CO., INC. Q-6-38
 424-438 W. 33rd St., N. Y. C.
 Please send me "38" catalog

Name.....
 Address.....
 City.....State.....

HAMMARLUND

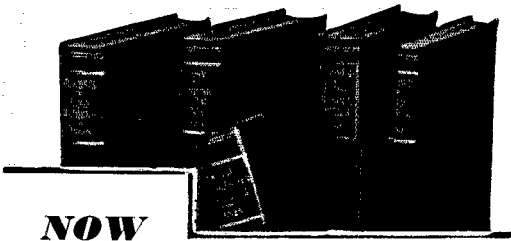

NOW
this high-powered radio engineering library

sent to you for 10 days' trial—
 at a special price and terms

These books cover circuit phenomena, tube theory, networks, measurements, and other subjects — give specialized treatment of all fields of practical design and application. They are books of recognized position in the literature — books you will refer to and be referred to often. If you are a researcher or experimenter — if your interest in radio is deep-set and based on a real desire to go further in this field — you want these books for the help they give in hundreds of problems throughout the whole field of radio engineering.

RADIO ENGINEERING LIBRARY

— especially selected by radio specialists of McGraw-Hill publications
 — to give most complete, dependable coverage of facts needed by all whose fields are grounded on radio fundamentals
 For home-study and reference. Contains a revised selection of books culled from latest McGraw-Hill publications in the radio field.

5 volumes, 3064 pp., 2000 illustrations

1. Glasgow's PRINCIPLES OF RADIO ENGINEERING
2. Terman's MEASUREMENTS IN RADIO ENGINEERING
3. Chaffee's THEORY OF THERMIONIC VACUUM TUBES
4. Hund's PHENOMENA IN HIGH-FREQUENCY SYSTEMS
5. Henney's RADIO ENGINEERING HANDBOOK

Special Low Price and Easy Terms

Bought singly, the five volumes comprising this library would cost you \$25.00. Under this offer you save \$1.50 and, in addition, have the privilege of paying in easy installments beginning with \$2.50, 10 days after receipt of the books, and \$3.00 monthly thereafter. Take advantage of these convenient terms to add them to your library now.

SEND THIS ON-APPROVAL COUPON

McGraw-Hill Book Co., Inc.
330 W. 42nd St., New York, N. Y.

Send me Radio Engineering library, 5 vols., for 10 days' examination on approval. In 10 days I will send \$2.50, plus few cents postage, and \$3.00 monthly till \$23.50 is paid, or return books postpaid. (We pay postage on orders accompanied by remittance of first installment.)

Name

Address

City and State

Position

Company QST-6-38
 (Books sent on approval in U. S. and Canada only.)

The same process is repeated in each circuit, making certain that the tube of the following stage is always in the circuit with filament lighted but with plate voltage off. A stage requiring it should be neutralized before any attempt at tracking is made. Once the circuits have been lined up accurately, it should be possible to twirl the frequency control dial from one end to the other with no noticeable change in either plate or grid currents, and it should be possible to dispense with all meters except possibly that in the final amplifier. A lamp bulb dummy load coupled to the final amplifier should show substantially constant output over the entire band.

The same process is followed in adjusting L_3 and L_4 for the 7-Mc. band. This band being narrower in frequency, will cover only 100 or so dial divisions. This is entirely sufficient for convenient adjustment. In order to maintain tracking, however, the 807 and final circuits must be adjusted to cover the full range of the oscillator harmonic of 7000 to 8000 kc. If it is desired to spread this band out over the entire dial, it will be necessary to use a separate 3.5-Mc. oscillator coil with C_5 connected at a tap which will provide tuning over the range of 3500 to 3650 kc.

The 7-Mc. oscillator coil for 14- and 28-Mc. output is designed to cover the range of 7000 to 7500 kc. so that its fourth harmonic will cover the wider band from 28 to 30 Mc. Therefore, the 14-Mc. band will also cover only a portion of the dial scale unless an additional oscillator coil covering 7000 to 7200 kc. is used. The combination of two and three bands with one oscillator and one buffer coil eliminates the necessity for changing these coils so frequently, of course. As progress is made toward the higher-frequency bands, the positions of the tuning taps will become more critical, but it should require only a few trials to determine the proper points for the taps.

Once the proper settings of the padding condensers have been determined for each band, the dial readings should be tabulated so that no time will be lost in changing bands. It is possible, of course, to prune the coils closely so that no adjustment of the padder condensers will be necessary when changing bands. This involves much cutting and trying, however, and besides it is usually considered desirable to use less circuit capacity for the higher frequencies and more for the lower frequencies.

ANTENNA COUPLING

Having progressed thus far with completely successful results, we were considerably disappointed to be unable to find a satisfactory answer to the problem of tracking the antenna circuit. Several types of tuned and untuned lines were tried. It was possible to keep the final amplifier and antenna tank circuits tracking with a constant coupling adjustment, but it was impossible to keep the loading constant within a hundred per cent or more. When the loading was adjusted for say 100-ma. plate current at one end of the band, it would increase to 200 ma. or more at the other end. Any adjustment of coupling to

PERFORMANCE *Not Claims* SELLS TAYLOR TUBES

Radio amateurs throughout the world bought 45,000 Taylor Tubes in 1937. (*A record of approximately one and a half tubes to every active "Ham."*) Year after year Taylor supremacy has stood unchallenged. Year after year Taylor sales have increased. Now for the first four months of 1938, Taylor Tubes has shattered its own first four months' sales record. There's a reason for this wide leadership—that reason is Taylor Tubes "More Watts Per Dollar" value. Taylor Tubes' best salesmen are the amateurs who operate Taylor Tubes equipped "rigs." Money-saving values, performance and the *best tube guarantee in the business* has created a unanimous desire among amateurs everywhere to recommend Taylor Tubes. Ask your distributor—he will confirm these facts about the leadership of Taylor Tubes.

READ THE FACTS

18,000 T-20's and TZ-20's in one year.
5,500 T-40's and TZ-40's in three months.
9,000 T-55's in 18 months.

Be wise—equip your new Rig 100% with Taylor Tubes! Buy by comparison.

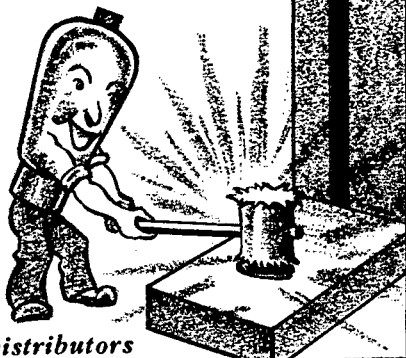

Recommended by Leading Parts Distributors

"More Watts Per Dollar"

Taylor **HEAVY CUSTOM BUILT DUTY** Tubes

TAYLOR TUBES, INC., 2341 WABANSIA AVE., CHICAGO, ILLINOIS

MORE NEW PRODUCTS FROM CARDWELL

TYPE FEX MULTI-BAND CONDENSER

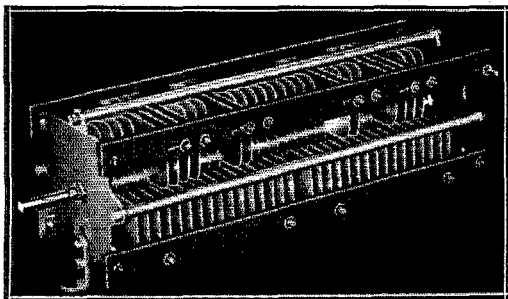

ONLY VARIABLE AIR CONDENSERS CAN GIVE YOU COMPLETE BAND COVERAGE

A good friend, ex WSAST, Mr. J. F. Smith from Alabama, looks over our XE-160-70-XQ Multi-band tank condenser and goes us one better. The type "FEX" makes use of one rotor effective on 3 separate dual section variable condensers in a single frame only 11 inches long.

A proper split-stator value for every band from 5 meters to 160 inclusive, all rolled up in one condenser.

Plug your coils into a single jack block.

Coil for each band connected to proper plugs to contact the correct capacity for an efficient "Q" for that band.

You can easily make a 9 jack master block or use any standard band switch to connect in the proper sections. Write for our bulletin on "How to Use Cardwell Multi-band Tank Capacitors."

EFFECTIVE BALANCED (SPLIT STATOR) CAPACITY RANGES FOR TYPE FEX

5 and 10 M.	— Range 1 —	5.8 to 18.5 mmfds. effective
20 and 40 M.	— Range 2 —	7 to 35 mmfds. effective
80 M.	— Range 3 —	10 to 50 mmfds. effective
160 M.	— Range 4 —	19 to 120 mmfds. effective

Note: Correct values are obtained to fit Barker & Williamson and Coto Coils

GENERAL SPECIFICATIONS

Airgap — .100". Effective airgap (2 sections in series) .200"

General Electric Mycalex Insulation.

Buffed and polished plates.

Dimensions — 4" x 4" x 11".

List \$25.00 — usual amateur discount applies.

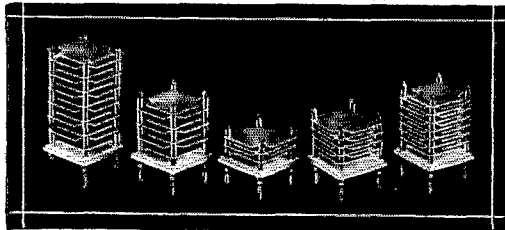

TYPE "J" PLUG-IN FIXED AIR CONDENSERS for a simple method for improving your (CL ratio for low frequency bands if you prefer to use (as many do), a standard dual section variable for tank tuning. (See QST ad in May issue)

QSY around the band, controlled from the operating table! Write for working diagram and instructions for a simple "Frequency-shifter" of Xtal stability. Uses Cardwell JR-750-OS Fixed air condenser, list price \$8.80

See new Cardwell products at National Radio Parts Trade Show, June 8-11, at Cardwell Booth — "207 Marconi Boulevard," Hotel Stevens, Chicago.

**THE ALLEN D. CARDWELL
MANUFACTURING CORPORATION**
83 PROSPECT STREET, BROOKLYN, NEW YORK

keep the loading at the proper value immediately upset the tracking. A half-wave 3.5-Mc. voltage-fed antenna tapped directly on the final plate tank coil through a 50- μ mf. variable condenser could be used maintaining satisfactory tracking throughout the 7- and 14-Mc. bands. The adjustment of loading by means of variation in the capacity of the coupling condenser did not upset the tracking. Over the wider 3.5- and 28-Mc. bands, however, even this did not solve the problem. Thus far, the most convenient coupling device seems to be the pi-section network. This adds two controls, but, if they are located near the frequency control dial, resonance in the final amplifier and loading may be controlled very conveniently. At any rate, we're going to put the system to work in our present transmitter which now has 8 controls. We figure the elimination of five of them will be well worth the few necessary changes.

The transmitter as it stands will make an excellent single-control driver for any high-power final amplifier. If higher power is desired, however, it would seem advisable to gang at least the final amplifier's grid circuit tuning along with the exciter tuning. About the only practical limit to the number of stages which may be ganged is reached when the number of condensers in the gang reaches the point where serious mechanical back-lash results from the accumulation of spring in the flexible couplings.

The Extended Double-Zepp Antenna

(Continued from page 16)

one is careful to use constant coupling to the wire, but its disadvantages are that coupling between the meter and line is both inductive and capacitive, causing the meter to read differently according to how it is held up to the line, and that the meter will also be influenced by harmonics.

The most satisfactory device seems to be a sensitive galvanometer in a miniature tuned circuit coupled to the line. Such a device combines sensitivity with freedom from harmonic distortion, but the effects of capacity are still there to some extent. The tuned circuit should therefore be carried along the line with its position relative to the plane of the two wires maintained constant. See Fig. 8. Checking along one of the two wires only is usually sufficient, but if one suspects an unbalance exists, the other line should also be checked. If the antenna system is reasonably symmetrical, unbalanced currents will most likely be due to improper coupling to the transmitter, but that is another story. At any rate, if a current maximum (voltage minimum) appears at the junction of transmission line and stub, the connection to the stub is too near the shorted end, and if the current is a minimum the opposite, of course, will be true. If the current maximum or minimum (assuming standing waves actually exist) does not occur near the stub, there has been a slip-up somewhere in the procedure, for this

A New THORDARSON Band Switch Transmitter Kit

Instantaneous Band-Switching From Front of Panel

Over any three pre-selected amateur bands

- ▶ 100 watts input on all bands.
- ▶ Single meter reads all plate currents as well as grid current of final stage.
- ▶ Power supply and R-F section on one chassis.
- ▶ Band-Switching feature optional, regular plug-in coils may be used.
- ▶ Tube lineup: 6L6G—6L6G—TZ-40.

PHONE OPERATION

- ▶ Plate modulation by a separate unit using a pair of 6L6's.

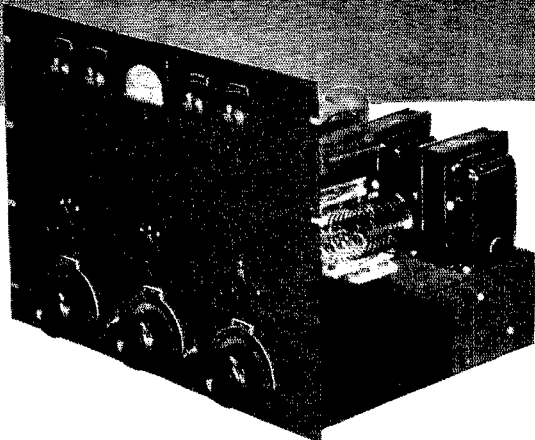

FOUNDATION UNITS

Completely punched chassis and panels supplied by Thordarson for both units. Full constructional details, photos, diagrams, etc. Standard parts used throughout. Fits standard relay racks or cabinets.

UNIVERSAL SPEECH AMPLIFIER

- ▶ Designed specifically for amateur transmitters.
- ▶ Sufficient driving power for any Class B modulator.
- ▶ Hum at absolute minimum.
- ▶ Output can be adapted to either Multi-Match driver transformer or 500 ohm line.
- ▶ Accommodates crystal microphone.
- ▶ Optional volume compression circuit.
- ▶ Tube lineup: 6F5—6C5—6C5—2A3's P-P.
- ▶ Foundation unit furnishing completely punched chassis, instructions, photos, etc.; suitable for standard relay rack or cabinet. Also screen cover and bottom plate available.

All three units can be seen at the Radio Parts Trade Show, June 8-11, at our booth 112-114 Coulomb Street, Stevens Hotel.

Available at your distributor's on or before July 1, 1938

Ask him or write to factory for free circular SD-378

THORDARSON ELECTRIC MFG. CO.

500 W. HURON ST., CHICAGO, ILL.

Demand "Power by Thordarson"



SERIES 840L

A.C. — D.C. VOLT — OHM —
DECIBEL — MILLIAMMETER

including a
2500 VOLT A.C. and D.C. RANGE
and a **1000 M.A. RANGE**

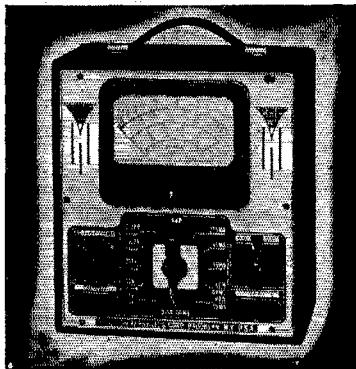

SPECIFICATIONS

- ★ 5 A.C.-D.C. Voltage Ranges from 0 to 2500 volts at 1000 ohms per volt.
- ★ 4 D.C. Current Ranges from 0 to 1 amp.
- ★ 3 Output Ranges.
- ★ 3 Resistance Ranges from 0 to 10 meg. (provision for self-contained batteries).
- ★ 5 Decibel Ranges from -10 to plus 63DB.
- ★ Large 4 1/4" D'Arsonval meter, 2% accuracy.
- ★ Wire wound shunts 1% accuracy.
- ★ Matched multipliers 1% accuracy.
- ★ Guaranteed close accuracy on all ranges.

Net price to amateurs **\$19.95** Less batteries and test leads

SERIES 840P incorporates same specifications as the 840L but is housed in an attractive black leatherette covered portable case with removable cover. Size 9 x 10 x 6. Net to amateurs. **\$21.95**

AVAILABLE AT LEADING DISTRIBUTORS

Following is a partial list

Atlanta, Ga.	SPECIALTY DISTRIBUTING CO.
Baltimore, Md.	RADIO ELECTRIC SERVICE CO.
Birmingham, Ala.	E. E. FORBES & SONS CO.
Boston, Mass.	RADIO SHACK INC.
Chicago, Ill.	NEWARK ELECTRIC CO.
Cleveland, O.	GOLDHAMER INC.
Columbia, S. C.	HARVEY RADIO CO.
Denver, Colo.	INTERSTATE RADIO & SUPPLY CO.
Everett, Wash.	PRINGLE RADIO ELECTRIC CO.
Hazleton, Pa.	ROBERT A. SYLVESTER
Los Angeles, Calif.	KIERLFF & CO.
New York, N. Y.	DIXIE RADIO CO.
Saginaw, Mich.	RADIO PARTS CO.
San Antonio, Texas	OLSEN RADIO SUPPLY
San Jose, Calif.	WHOLESALE DIST. CO.
Scranton, Pa.	SCRANTON RADIO SUPPLY CO.
Springfield, Mo.	RADIO ENGINEERING SERVICE
Staubenville, O.	LEVINSON'S RADIO SUPPLY
Utica, N. Y.	VAETH ELECTRIC CO.
Vancouver, B. C.	HYGRADE RADIO SUPPLIES

P R E C I S I O N
A P P A R A T U S C O R P O R A T I O N

821 EAST NEW YORK AVE., BROOKLYN, N. Y.
EXPORT DIVISION — 458 BROADWAY, NEW YORK

will be evidence that the stub itself did not tune the antenna to resonance.

PARASITIC ELEMENTS

The use of spreaders several feet in length to support each end of a "flat-top" antenna composed of two wires is again becoming popular, and for a good reason. Gains of around 5.5 db for a bi-directional array and around 7 db for a uni-directional array are thus made possible. One of the most promising arrangements is that of two double-230-degree antennas supported parallel to each other only 0.2 wavelength apart, as illustrated in Fig. 9. Antenna A is excited by the transmitter using the same technique as when exciting a single double-230-degree antenna. Antenna B may be tuned by proper positioning of a short on its stub to become either a director or a reflector. In fact, this stub might be extended by multiples of a half wavelength to enter the operating room where, by means of a single switch the shorting position may be changed from that corresponding to a director to the position corresponding to a reflector, thus reversing the directivity of the antenna system. Information as to the gain of such an antenna system when one antenna is used as a director is not available, but when it is used as a reflector and adjusted to give a *minimum* signal to the rear, the signal forward will be 7 db better than a simple doublet, and the signal backwards will be 7 db less than from a doublet, resulting in a front-to-back ratio of 14 db. Adjustment of the reflector shorting bar should be on the basis of minimum backward signal from the antenna, or minimum signal received from a station in that direction when using the antenna system for reception, since this adjustment can be made more accurately than one resulting in maximum front signal. This will minimize QRM for both transmitting and receiving. The same principles hold true when adjusting the auxiliary antenna for use as a director.

If adjustments of the auxiliary antenna are to be made when transmitting and an ammeter is temporarily inserted in the shorting bar, minimum backwards signal will occur for the reflector when the short is moved slightly further from the antenna than that position corresponding to maximum current through the short. For the director, optimum conditions will be obtained when the short is slightly closer to the antenna than the maximum shorting current position. From this it can be seen that the proper adjustment of the auxiliary antenna is quite critical and certainly very important. Since field strength instruments are not generally available, a receiver fitted with a signal strength indicator of some sort located within a few miles of the antenna and in the desired direction should prove to be the next best thing. Connecting your own receiver to the antenna, with the other fellow transmitting, is perhaps even more practical in search for that minimum-signal adjustment.

The presence of the auxiliary antenna only 0.2 wavelength away from the driven antenna and adjusted properly for maximum forward or back-

PRIDE OF POSSESSION

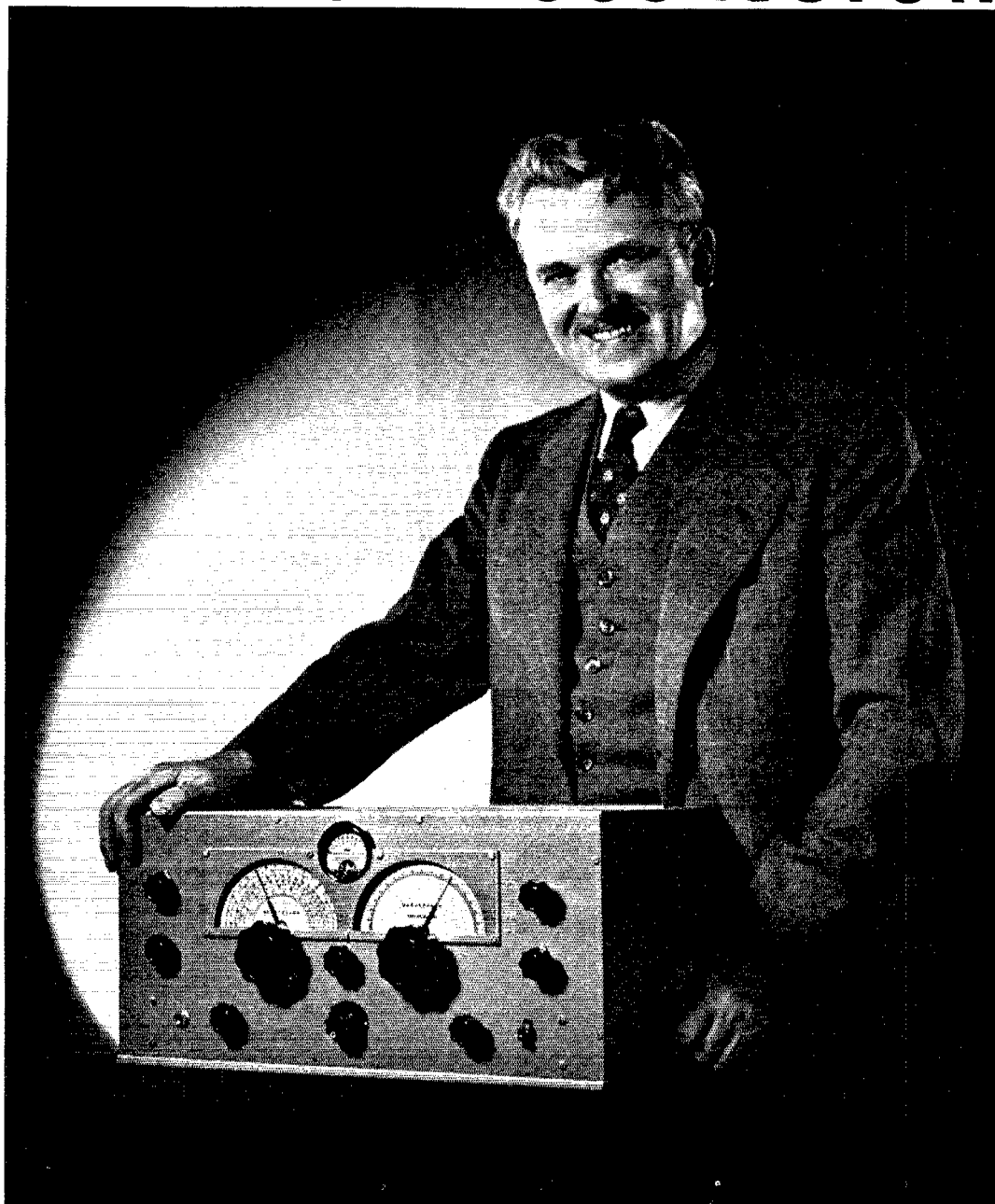

The satisfaction that comes from the ownership and operation of an RME-69 Receiver can only be measured by its actual performance. Thousands of users can vouch for this fact.

*You will see these receivers at the Chicago Trade Show in
June—208 Marconi Boulevard*

RADIO MFG. ENGINEERS, INC., PEORIA, ILLINOIS

Say You Saw It in *QST* — It Identifies You and Helps *QST*

QUALITY ALONE

SELLS THIS RECTIFIER

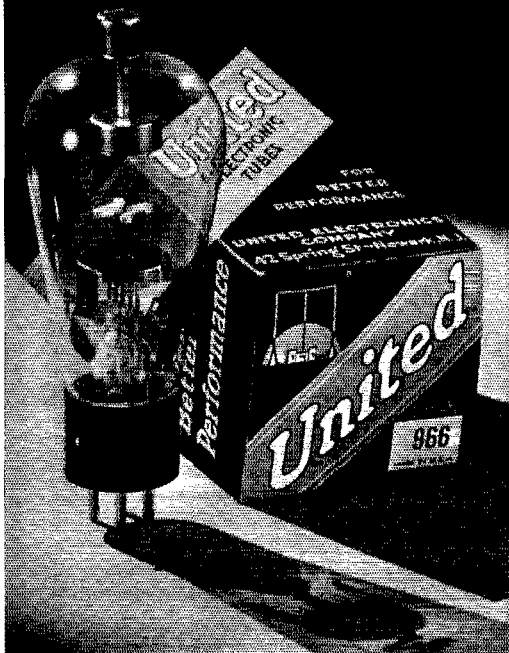

UNITED 966 (866). This rectifier became one of the leading tubes of 1937—not because of its low price, but purely on its easily recognized superior standards. Pick up a set of UNITED 966 tubes and compare with any other make.

DEFLECTING BAFFLE. Notice the Svea metal baffle to keep proper balance between condensed mercury and ambient temperature—a very important factor.

NO EXCESS MERCURY. Notice the way the mercury has been introduced in a measured amount—the complete absence of excess free mercury to splash around the tube and contaminate the elements—no mercury amalgams on baffle, filament or anode.

QUICK STARTING. Put a set of these rectifiers in your transmitter—don't wait for the usual 15 minutes pre-heating—they'll start safely in a few seconds. This is only guaranteed with UNITED 966.

Insist on UNITED rectifiers next time. They are interchangeable with type 866 of all makes. If your dealer is out of stock—send us your order.

Price \$1.50

UNITED ELECTRONICS CO.
42 SPRING STREET
NEWARK NEW JERSEY

ward radiation will obviously affect the radiation resistance and impedance of the driven antenna. As a result, if the auxiliary antenna is left open-circuited and the stub on the driven antenna is adjusted in accordance with the method previously given, this adjustment will not be correct when the auxiliary antenna is, in turn, properly tuned. Moreover, the impedance of the driven antenna will differ slightly according to whether the auxiliary antenna is tuned as a director or as a reflector. If quick change from reflector to director is contemplated, some sort of compromise is indicated in the adjustment of the stub on the driven antenna.

From a practical standpoint, however, the adjustment of the auxiliary antenna should be made first, be it reflector or director, with the driven antenna excited by the two-wire transmission line without a correcting stub. This may require temporary adjustment of the transmission-line length, either physically or by means of series coils or condensers, to bring a low-impedance point at the coupling coil to the transmitter in order to load the latter satisfactorily. In fact, if the line length from antenna to transmitter is not more than a wavelength or so, the reduction in line losses resulting from the use of a correcting stub is hardly worth the trouble of installing it. The point is, if a "flat" line is desired, adjustments of the stub at the driven antenna should not be made until after the auxiliary antenna has been tuned to give the desired radiation pattern.

LARGER COLINEAR ARRAYS

Now let us suppose our backyard is big enough to hang up more than two doublets end to end. An interesting possibility would be a four-element array of 230-degree elements. But here the principles of the extended double-Zepp must be carefully considered in designing the length of each element and the length of the phasing stub separating them. The actual arrangement will be as shown in Fig. 10. Both degrees and dimensional designations are used to indicate the electrical and physical length of each element. The length of the stubs indicated is approximate only and must be adjusted for best results. The lengths of the various antenna elements as shown, however, may be assumed correct. The transmission line can be tapped on to any of the stubs, but connection to the center one will give the greatest gain.

The principle of the design shown for four elements is to provide the same separation in space between each doublet center as is provided between the two doublet centers in the double-230-degree antenna. Each phasing stub will, of course, be considerably shorter than a quarter wavelength, and when adjusting their length to tune the whole antenna to resonance, all three stubs must be made the same length; that is, if one is shortened two inches, the other two must also be shortened by two inches, assuming they were all the same length to start with.

This may prove to be an awkward and tedious method of adjustment, but the procedure may be simplified by adjusting the length of the center stub only as a first approximation. The use of an

NATIONAL TRANSMITTER

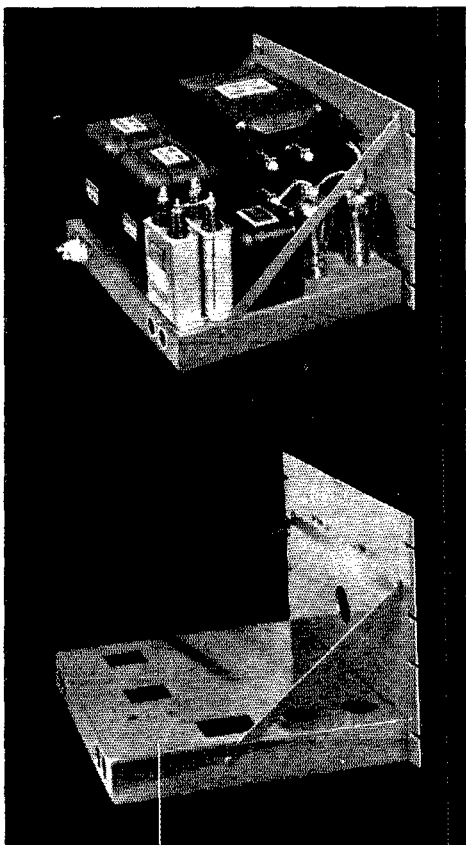
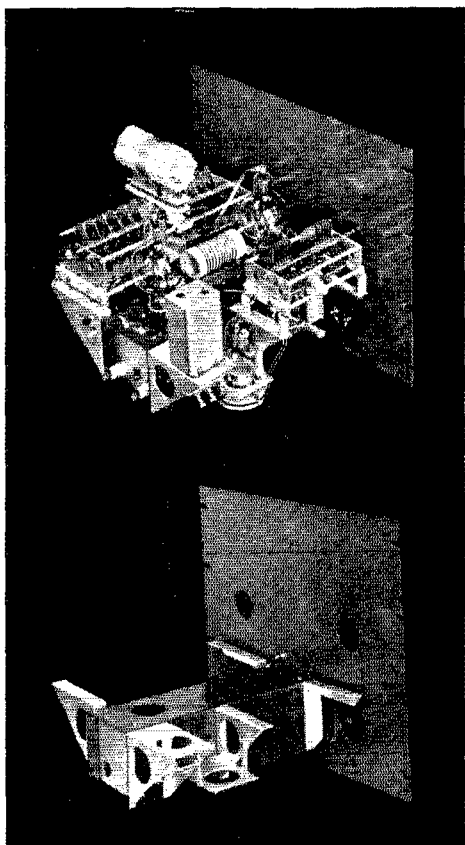

FOUNDATION UNITS

Thoroughly engineered and reasonably priced, the National Transmitter Foundation Units turn the home-built transmitter into a professional job. They are carefully designed for convenience, for performance, and for ease of assembly and eliminate the usual headaches of construction. Illustrated at the left is the final amplifier using Eimac 100TH's, shown both assembled and in chassis form. It provides a compact, symmetrical assembly complete even to the filament transformer. At the right is the high voltage power supply unit. Other chassis include a Class B modulator and a medium voltage power supply. Other National transmitting equipment includes the completely wired and laboratory tested Type NTE Speech Amplifier and Multi-band Exciter as well as a complete line of small parts. A complete transmitter using this equipment is described in the Thordarson Transmitter Guide as well as in our Engineering Booklet entitled, "A 600-Watt Transmitter." A complete listing is given in the National Catalogue Supplement. At your dealers.

NATIONAL CO., INC.



MALDEN, MASS.



ADD-A-UNIT TRANSMITTER KITS

STEP BY STEP TOWARD AN
EFFICIENT 500 WATT RIG
THE ECONOMICAL WAY TO BUILD
YOUR TRANSMITTERS

No. 3.....\$13.95

Antenna Coupling Kit.
May be used with any
transmitter combination.

No. 4.....\$49.75

500 Watt RF Amplifier.
Self-contained power
supply.

No. 1.....\$49.75

A complete exciter or 80
watt CW Transmitter.
Self-contained power
supply.

No. 2.....\$44.50

50 Watt Modulator.
Self-contained power
supply. Combine with
Unit 1 for complete
phone transmitter.

No. 5.....\$49.75

250 Watt Class B Modu-
lator. Forms a complete
450 Watt Phone Trans-
mitter with Units 1, 2
and 4. Self-contained
power supply.

*Prices do not include tubes,
meters or crystal*

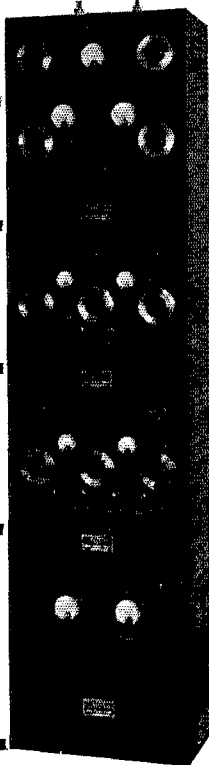

Build your transmitter according to a definite predetermined plan. This Utah Add-A-Unit Transmitter is built around a high efficiency circuit of matched, tested parts — no false starts, no discarded parts. Add each unit as you can afford it — the economical, sure way of acquiring your transmitter. See your jobber or write Dept. Q6 for complete details.

*Visit Utah Booths 113-115 Marconi Blvd.,
Chicago Radio Parts Show*

UTAH RADIO PRODUCTS CO.
CHICAGO, U. S. A.

Cable Address "UTARADIO" Chicago
BUENOS AIRES — UCOA RADIO PRODUCTS CO.

"16 YEARS OF LEADERSHIP"

"exciter" antenna temporarily rigged nearby is assumed. If it is found the center stub must be shorter than the other two stubs by 3 feet, for instance, in order to obtain maximum current through its shorting bar, the other two stubs should be shortened by 1 foot and a new position found for maximum current through the center stub. This new position should correspond closely to equal length for all three stubs. This procedure of tuning the four-element array should be followed even though a stub at the center will not be used, finally, its place being taken by the transmission line itself. Such a connection will result in standing waves along the line and it will have to be "tuned" to permit easy coupling to the transmitter or receiver.

The horizontal pattern of the four-element array just described will have two major lobes at right angles to the antenna and several minor lobes of small amplitude. The gain in actual practice has proved to be greater than anticipated, and probably is more than 7 db. The major lobes will be much narrower than for the double-230-degree antenna, thus requiring more careful "aim" in erecting the array, or provisions for swinging it about. It is assumed this array, as well as the others described, is hung horizontally. It may be hung vertically, of course, but the possible restrictions due to sharp directivity in the vertical plane should then be considered. In general, the horizontally polarized antenna will prove most practical, chiefly because the ground reflection usually encountered with vertically-polarized radiations is inferior, and because high masts are not often available.

The adjustment of the antennas described in this article may seem a bit involved as compared with the simple doublet or the double-Zepp antenna, but the extra gain thus made available should make their use worth while. For that matter, the double-230-degree antenna need not be tuned at all, its construction being made in accordance with the dimensions given and the transmission line tuned to fit the transmitter. In this respect the simplest of all directive antennas, size and gain also taken into consideration, is the extended double-Zepp.

LEARN RADIO — TELEVISION —

500 Licensed graduates placed in past 7 years in shipping, broadcasting, aviation, police, etc., we also teach radio servicing and repairing; new term Mar. 14, May 9, day or eve., 52-page catalog free; oldest, largest and best equipped.

MASS. RADIO SCHOOL
18 Boylston Street, Boston

G. R. Entwistle, Pres.
Established 1899

R. F. Trop, Treas.
Hancock 8184

FIVE LEADERS

HY 40 \$2.75

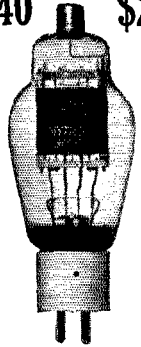

HIGH EFFICIENCY TRIODE
 Fil. 7.5 volts 2.5 amp.
 Plate Volts 1000 max.
 Plate Dissip. 40 watts

HY 25

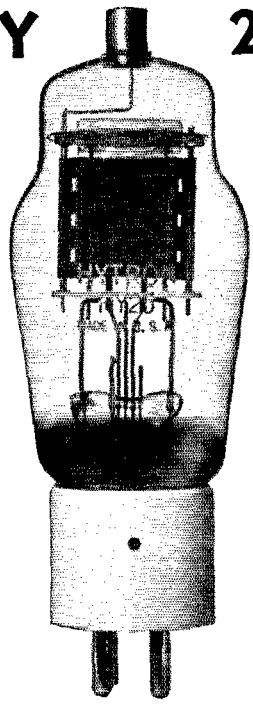

\$1.45
GENERAL PURPOSE TRIODE
 Fil. 7.5 volts 2.25 amp.
 Plate Volts 800 max.
 Plate Dissip. 25 watts

\$2.50 HY 60

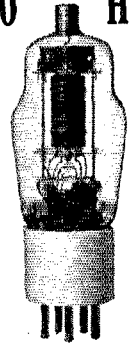

BEAM TETRODE
 Fil. 6.3 volts .6 amp.
 Plate Volts 350 max.
 RF Output 16 watts

866 Jr. \$1.05

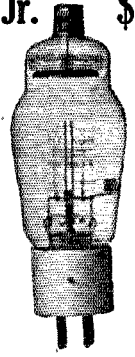

MERCURY VAPOR RECTIFIER
 Fil. 2.5 volts 3.0 amp.
 R M S Volts 1250 max.
 D. C. per pair 250 ma.

\$3.00 HY 61

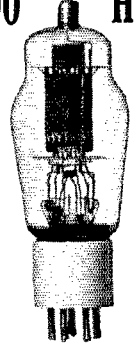

BEAM TETRODE
 Fil. 6.3 volts .9 amp.
 Plate Volts 600 max.
 RF Output 37.5 watts



HYTRON LABORATORIES

SALEM MASS.

A DIVISION OF THE HYTRON CORP.

VISIT OUR BOOTH AT THE CHICAGO SHOW—109 EDISON STREET

Say You Saw It in QST—It Identifies You and Helps QST

STATION ACTIVITIES

(Continued from page 52)

CENTRAL DIVISION

ILLINOIS—SCM, L. John Huntoon, W9KJY—Emergency work is the keynote of this month's report. In the various sleet storms in Illinois during late March and early April, amateur radio came to the rescue in many cases. 9JLK, OBN, SXL, MME, CEO and QZB did fine work for the Bloomington Power Company in keeping contact with Morton, Ill., through ERE—all on 1.75-Mc. 'phone. The boys in the southern part of the state had the situation well in hand during the March tornado. And when another sleet storm destroyed all communication with Quincy, Ill., VEE handled quite a bit of traffic, especially Assoc. Press from Chicago through HPG and MRQ. FB, OM's, AA likes his new shack in the basement. After over a year of waiting, YDA finally received a card from VK6LG. RWS again falls just short of BPL. MLH has gone to the land of the K6's to become announcer at KGMB. Trunk line "I." shut down for season. So NPI has more time for A.A.R.S. work. VES is again O.R.S. VS is anxious to stack his SX16 against KJY's 10LX. 'Phone Net on 3940 kc. is coming along nicely under able direction of HQD and MWC. I.H. is moving to Elmhurst and the wide-open spaces. New HRO receiver at NLF. NXG reports BEF new in Greenville. A recent high wind took all but 30 feet of QKJ's mast. PNV is building emergency equipment. THB has a portable station, a.c. or battery-operated. A new member of the A.A.R.S. 'Phone Net on 1887 kc. is ACU, with battery power. WSF evidently tried tuning "with his tongue," as BRY reports the r.f. burn he received required medical attention. In anticipation of some unusual 56-Mc. conditions, SKR is building some new equipment for that band. ATS is looking for an early morning 3.9-Mc. 'phone schedule. Coyne Radio Club, UEU, operates quite a bit on 56 Mc. BPU promises the Bloomington gang will come "en masse" to the National Convention. DX at 1:00 A.M. still holds interest for HQH and GMT. HUU, ULJ, GBT and MLJ visited the Clinton, Iowa, gang recently. In the June Field Day, 3765 kc. will be the frequency for Illinois state stations who want to contact each other for the purpose of testing emergency equipment.

Traffic: W9RWS 474 EC 458 RMN 398 (WLTR 468) NPL 245 KJY 153 (WLTK 54) MRQ 118 YZE 116 HPG 87 (WLTI 10) MCC 86 VEE 75 (WLTO 23) DDO 70 RVF 50 VES 34 DOU 23 CEO 17 KMN-VS-TUV 12 QKL 10 HQH 6 MWC 5 ILE-NHF-NXG-PNV 4 QKJ 3 THB 2 ACU-BRY-AA 1.

INDIANA—SCM, Nobel Burkhardt, W9QG—W4FAG is to return to Indiana. W9AB wants to trade one Asian contact for five anything else. The equipment at AEU takes up all the room on a 15-foot operating table. CB is getting out with 18 watts to RK25. DJU's brother went up for a ticket. EGQ reports by radio. EPR says his call means "Electric Peanut Roaster." FTF has new modulator. GHF is on 1925 kc. HKQ's handle is Ivan. HPQ would like to see more activity on 56 Mc. HUV finally worked a J1JNJ at last got a card from a foreigner. JXA applied for O.R.S. KIC built a 20-watt emergency rig. LKI has first-class radiophone. LLV has new Jr. op, Thomas Edison Hope; arrived Mar. 30th and has good mike voice already! LSW is kingfish of I.R.G. LSZ had misfortune to have lightning fly around his transmitter and light. MBV reports A.E.C. registrations coming along fine. MCH will soon have 500 watts. MIG invites visitors to Radio Club. MTZ uses 35 watts. MUR has been experimenting with mobile 56 Mc. NOZ works low-powered stations on 3.5 Mc. OXM had visitors from Kokomo and Ft. Wayne. PIF's handle is Glenn. PWZ reports about stations in Ft. Wayne. SLS is on 1.75 Mc. SXU uses a '10 final. SYJ has new 14-Mc. antenna. TG is a leading cog in I.R.G. TYF handled a little traffic this month! UTL pounds the ether from Trafalgar, and WOD had a remote-controlled wagon at Rose Poly Show. Bigger and better DX is WCE's motto—46 countries. YUJ says his call means "Your Uncle Jack." YWE hopes to be on 1.75-Mc. 'phone soon. YXT has a new Jr. op—Congrats. OM. ZYX changed his opinion of 807's. EKD had an antenna-raising party to put up his 54-foot mast. Refreshments were served. Among the 15 or so in attendance were AXE, VEK, TE, CYQ, QG, JPX, UZQ, VFN and DSC. The Indpls. Radio Club is planning a trip to Purdue for the Open House exhibit. The So. Bend Amat. Comm. Soc. will

have a soft ball team in one of the city leagues this summer. They also are making plans for activity in the St. Joe Valley Motorboat Regatta in May. DLM-9 operated at the second annual Studebaker Outdoor Show and was operated by TYF, AMI, DLM, UYP, PDS and FHB. This station made B.P.L. for the first time any station in this Section has done so since the S.C.M. took office. A lot of traffic was originated. Just a word of suggestion along this line. Whenever any of the gang want to do something of this kind, it would speed up things considerably to get hold of the S.C.M. or an R.M. so that definite state-wide traffic schedules can be arranged. Also do not accept messages unless the FULL ADDRESS is given. If a 'phone number can be obtained, get it. A fine job of emergency work was done around Ft. Wayne by the E. C. 9VMG.

Traffic: W9AB 25 ABB 64 AXH 2 CB 45 DLM 537 EGQ 5 FB 75 HPG 7 HUV 1 MBV 2 NOZ 4 QG 117 (WLHL 109) SYJ 43 TRN 5 TYF 417 YZE 24.

KENTUCKY—SCM, Darrell A. Downard, W9ARU—This Section has suffered the loss of one of its most beloved and well-known amateurs—J. Clayton Kuhn, W9HPQ. Clayton was Secretary-Treasurer of the Amateur Radio Transmitting Society, Louisville, and Editor of the Club's paper, the *Blue Grass Ether Clippings*. His passing has left a wound that time only can heal. BAZ will soon be on 'phone. EDQ uses a Collins' system. HAX reports College station getting along swell. TXC is building a new radio room at his new QTH. MYL finally left Warsaw for Cincinnati, but will work into the Ky. Net. AWH is back on the Ky. Net. ELL's chest has taken on a couple more inches—if that's possible—due to his QSO with VR6AY. UWR runs 70 watts on 3.9-Mc. 'phone using emergency gas-driven power supply. SZK is now a W4 in Florida. JWE and LCM are newcomers in Ashland. OTC and BPI are both tearing up the ether. QHQ, QQM and YYP all have Gross CB55 rigs. QPO is new one in Paintsville. EAC uses 6V6G's on 1.75-Mc. 'phone. WGZ runs 'em out with a kw. ZUZ has an FB emergency rig running 275 watts on c.w. and 70 'phone from 800-watt gas-driven power house. If you fail to find any dope on YOUR activities, you either didn't mail a report—or it was too late. Mail it by the 16th at least.

Traffic: W9EDQ 176 ARU 140 HAX 111 CDA-BAZ 41 MYL 38 PKW 26 HBQ 22 VYY 16 AUH 15 TXC 8 ELL 7.

MICHIGAN—SCM, Harold C. Bird, W8DPE—Michigan Eights: NUV made the B.P.L. for the first time, Orchids to you, Vic QGD also made the B.P.L. FB. Al. BTP has been getting all-band rig fixed up. NQS' 1.75 and 3.9-Mc. ants. blew down in high wind. MPX is still scheduling OQ5AA. Congrats. EX is all set on 56 Mc. for the summer. NXT rebuilt rig twice in one month. DED reports MYF and NLV getting active. QDX had longest QSO (three-way) with QMN gang, 4 hours and 45 mins. PP has come to life. Glad to see you, OM. DSQ reports new hams: RPN, ROH, RNX, RRX, RQS, RSQ. MBM reports FRW on 28-Mc. 'phone; JXE on 1.75-Mc. 'phone. NDJ has been doing nice job as N.C.S. on net. RHC reports moving station and rebuilding antenna. GQZ is going to try 36 Mc. OFJ returned from Glendale and will be with us shortly. QZV reports LAK has new baby boy. Orchids to LAK. MDG and PKQ are new reporters. IFE has 56-Mc. Club in Detroit with following officers: Pres., Ed Koehn; Vice-Pres., Ken Stecker; Secy., Fred Moose. They are soliciting members. CMH is new O.R.S. OCC ordered QMN crystal. ROL is in net quite regularly. SJO is going to be best man to 9EXT and x-PCU. Wedding in June. Suggest the gang send radiograms and wedding messages to them. CSL is on again. Somehow HKT's QTH got mixed. It's St. Joseph, Mich. Sorry, OM. CAT is active again and sends report by radio. CPY and PRA report by radio. Michigan Nines: IIT reports mail started again. HSQ is going strong. CWR, our new R.M., wants to give credit for FB cooperation in keeping U.P. Net functioning and keeping contact with QMN. I want to thank each and every one of you fellows and gals for the fine cooperation you have given me during the season, and hope that you will try and keep the cobwebs off the rig during the summer so we can have an outstanding emergency set-up. With very 73 and luck—Hal.

Traffic: W8QGD 618 NUV 565 ROL 201 LSF 198 NDI. 147 JZD 102 JKO 88 PRA 73 PYT 72 DPE 70 JUQ 44 FX 48 CAT 46 QR 36 QDX-DYH 33 QQS 28 MPX 20 CPY 19 BRS 16 NXT 14 LND 8 CMH 7 RJC 6 MBM 5 JO-DED 4 HKH-PKQ 3 QZV 4 WHSQ 76 IIT 52 GJX 24 CWR 16.

OHIO—SCM, E. H. Gibbs, W8AQ—LATU leads the

Section in traffic after very consistent work all season. Congrats, C. J.! He has new rig, too, PP. 809's final. LZK is building portable emergency-powered rig. PIH increased power to 10 watts, now c.c. EBQ is another with a new rig. 6LX-P.P. 801's. Welcome to LVH of Lakewood, new O.R.S. WE operates portable from Columbus with a 6L6, pending permanent QTH. LCV ground new 3710 crystal to replace the cracked chirper. OHO added a pair of '10's with 75 watts. Ice storm lowered DWT's antennas. NXN has been appointed Emergency Coordinator for greater Toledo. RHC is armory station at Toledo on 3640 kc. NUO intends helping LZK work real DX on 56 Mc. LOF is moving soon and plans beam antenna. PGI has new rig with T-55 final. RIX has a new antenna and reports much 56-Mc. interest in Canton. RN is in operation on the lakes on KFMK (S.S. Pioneer) this season. LAU received his W.A.S. ticket. BYM is rebuilding rig and antenna. Tests on storage battery rig at CVZ turned out fine. PUN is rewinding a generator for a.e. emergency power. OVL of Dayton joins the ranks of O.P.S.; he has been building experimental antennas and new exciter unit. KNF built an e.c. oscillator tunable from operating position. FNX moved to 14 Mc. to dodge static on 3.9. HFR had visit from 2HTI. Greater Cincinnati A.R.A. puts out a paper, *The Mike and Key*—one of the best we've seen. EMK is building emergency equipment with 500-watt a.c. generator. FSK did some nice work with 6 watts input to an 807 on 3.9-Mc. 'phone. PNF is moving to 14 Mc. as soon as 3.9 folds up for the summer. LKU takes part in the Ohio River Net on 3.9 Mc. each Sunday afternoon. GMI has fun with 4 watts to 6D6 rig on 3.9-Mc. 'phone. KKH got his second tower up, with the help of BBG. WI is building two new supers. KEQ has a 14-Mc. Q in a 65-foot tree. (HER, our QSL Manager, needs Asia for W.A.C. PKS has been putting up new 8JK beam. PZO moved to 10801 Hull Avenue, Cleveland, and is rebuilding for 28 Mc. GDC moved to Carrollton. DXB is increasing power on 36 Mc. The meetings at Toledo, Cleveland, Akron, Cambridge and Marietta addressed by JJPE from A.R.R.L. Hdq. were interesting and well attended.

Traffic: W8LVU 402 LZK 395 PIH 254 LZE 179 BBH 118 (WLHA 289) EEQ 114 LVH 99 MQO 97 WE 60 AQ 43 HCS 39 NKU 33 ICC 32 LCV 23 MUR 18 OHO 15 CVZ-VZ 9 EQN 8 PUN 7 OVL-DWT 6 NXN-KNF 5 FNX-NYY 4 HFR 3 PVW-NUO-AXQ-FHB 2 PNJ 1.

WISCONSIN—SCM. Aldrich C. Kronos, W9UIT—The April meeting of the Rock River Radio Club was held at the home of 9MOX, Waupun. There was a real turnout, including a gang from Oshkosh. Plans were made for the hamfest which will be held the latter part of July. APU has new '03A Class B modulator. BCY worked W.A.C. four times in the 'Phone Contest. HDT is a new man since his return from the South. GTJ is trying his luck on 14-Mc. 'phone. OQY is moving to new QTH. QMT joined the Naval Reserve. TPY works ZS's on 28-Mc. 'phone. VZX has new 28-Mc. rig. YOA is using new pair of T-40's in final. ZWY works out FB with a 6L6 on 7 Mc. IZG and ADK schedule on 28-Mc. 'phone. OFL had score of 1326 pts. and 17 countries in 'Phone Contest. CCI had a score of 16,576 in C.W. Contest. DIG is rebuilding to get more drive to his final. MOX has a pair of ten's in final. JVV is doing fine job as Hamfest Mgr. for Rock River Radio Club. DPR is now using M.O.P.A. in State Net. ONI checked his rig with an oscilloscope. RZY is winding chokes and transformers for new rig. WYT has been transferred to Duluth as Postal Telegraph op. DZI is trying to organize an N.C.R. unit in Superior. RJB is new ham in Superior. The State Net has been progressing very nicely. ALL members reporting in regularly. Keep it up, fellows. ZTP, new member of State Net, is doing fine job for Milwaukee. UIT, after stalking VR6AY and WIOXAB for months, worked them both within a half hour. NEZ and HWI are new hams in Coon Valley. ZLM bought new receiver. ZWZ is going on 14 and 7 Mc. AKY was appointed radio interference inspector for LaCrosse. YEX is active. PRM is working hard as E.C. for Wausau and has organization well in hand. LED had a new T-40 final. RLB put up his skywire for the third time this season. WSY has worked 61 countries with low power. LWX is building new shack. ZTO has worked 36 countries to date. HKE, new ham in Madison, is using a pair of 849's final. RNX is going strong on 14-Mc. 'phone. SZL is active as usual, holding down his many jobs. SST and IYL were interviewed on a ham program broadcast at Champaign, Ill. VVQ is working out well with single '45 final. GWK and AKT are active in traffic work. HGF is active in Beloit.

QUD has pair of T-20's going and looking for new states for W.A.S. Thanks, gang, for all the fine reports. Don't let the "summer slump" get you.

Traffic: W9SZL 137 (WLTJ 34) (NCR 19) GWK 174 IYL-HGF 30 NRQ 21 (WLTQ 10) ZTP 31 ZTO 7 UIT 6 VVQ-RLB 2 AKT 27 ONI 40 (WLTN 25) HSK 5 (WLTQ 5).

MIDWEST DIVISION

IOWA—Acting SCM, Phil Boardman, W9LEZ/WLUD—The season for hamfests and 56-Mc. activity is at hand with the Burlington and Council Bluffs Clubs planning events. Members of the Council Bluffs Radio Operators Club did very fine work in the recent emergency in Nebraska. Congratulations. ARE is new O.R.S. NVF has a bug in the rig. ARE has new Super Skyrider. ACL received Trimm 'phones for birthday. TGK reports via radio. AHX operates Army radio WZT, and is ex-K6NRF. YRO worked ZL on 7 Mc. with only 35 watts. ZTR will be on 14 Mc. ZTV has new 809 final. WWY built flea-power 'phone rig. YQY needs 7 states for W.A.S. TJA is going to make variable frequency exciter. PEX is new ham in St. Louis City. FSH is on 3.9-Mc. 'phone. QVA is new Burlington ham. WNL is active on 7 and 3.5 Mc. QGU is on 56 Mc. TMY is working on ten tube super. NLA has 1 kw. on all bands including 56 Mc.!! WTD is running 115 watts on 56 Mc. PJR did heroic work for Bell Telephone Co. during recent sleet storm. SHY joins boys on 56 Mc. PEA sticks to 1.75 Mc. WMP is working both 1.75 and 56 Mc. QOQ is newest ham in Ft. Madison. ADA needs only 5 cards for Century Club. LDH worked a few in W/Ve Contest. YZK has T-55 on 1.75 Mc. ACF is on 7 Mc. NDH is hunting elusive DX on 14 Mc. MZM is planning 6L6 tri-tet. IXB soon will have a T-20. PDM is proud papa of a YL. GFQ works duplex by rebroadcast of 56 Mc. signals on 1.75 Mc. CCY handled emergency traffic. PGG is back to 1.75 Mc. REV had rig at Hobby Exhibit. QUF is going fine on 3.5 Mc. IBR's new rig will have a pair of 250-TH's in final. JRY worked lots of DX 'phones on 28 Mc. in contest. STE is now op for United Airlines in Cleveland, Ohio.

Traffic: W9LEZ 145 (WLUD 156) NVF 153 ARE 79 JMX 67 ACL 61 DEA 43 TGK 11 DUA 10 PDM 2 SEE 6 CCY 29.

KANSAS—SCM, Harry E. Legler, W9PB—Our Section came through in fine style, providing excellent emergency work incident to a late winter blizzard. QQQ at Manhattan carried off traffic honors when that station was the center of attraction during Engineer's Open House. Ass't S.C.M. UQX reports 38 A.E.C. registrations and is organizing them into an active emergency net with seven sub-divisions. Route Manager and Trunk Liner UEG says Trunk "E" has suspended schedules for the season, but he will be active on 7 Mc. for traffic this summer. WIN handled loads of traffic besides considerable emergency work. 5GSM/9 will soon be a permanent W9. GRR, new at Wichita, is active in N.C.R. MFH is busy with convention plans as General Chairman. YRS expects to go to 14 Mc. for the summer. SIL is a consistent traffic reporter and NCR worker. YOS is enthused about being heard on 4 Mc. by ON4AU. QML and SNZ are handling traffic for students at Hays Teachers College. EJD is very busy with N.C.R. duties. BYV lost antenna in blizzard. ZFS welcomes any traffic coming his way. RUN writes from Brownsville, Tex., where he operates for Braniff Airways. AWR forwarded A.E.C. application. QNU, a new Section member, is Army pilot at Ft. Riley. Other new members heard from are ZSM, AVQ, Dick Cahill and ex-9CWO, who took license exam to get on air again. ZJA is rebuilding to use pair of 80L's final. CVN is a big help to UQX in getting out A.E.C. bulletins. RAT reports for the Coffeyville Club; they are going in for A.E.C. work with a vengeance. This go-getting club includes JKS (new call), KEF, YLY, LTO, RUE, PXW, YQD, RMP, EFE, QQI, QNQ and RAT. A reporter asks why so much of his letter to S.C.M. does not appear in QST. As mentioned in these reports previously, the "blue pencil" at Headquarters eliminates any negative activity. Only worthwhile work and activity of interest to the whole Section is accepted for publication.

Traffic: W9QQQ 333 WIN 275 UEG 209 YAH 149 5GSM/9 126 9MPH 105 YRS 82 SIL 44 YOS 37 QML 13 EJD 5 BYV-ZFS 4.

MISSOURI—SCM, Letha Allendorf, W9OUD—Some of the gang did nice work during the sudden snowstorm of April 8th. KEF, PYF and TOM helped bridge the gap

(Continued on page 88)

quality above all

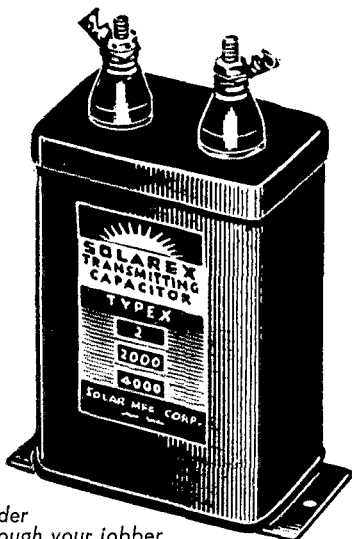

Order
through your jobber

SOLAR MFG. CORP.

599-601 Broadway, New York, N. Y.

Take a Tip . . .

You will find it to your advantage to buy from Bob Henry, W9ARA. You get personal attention, ten day trial of all receivers, fair trade in value for your receiver or equipment, and terms financed by W9ARA so you can buy with less cost and less red tape. No wonder Bob Henry's customers are boosters. You will be too.

IN STOCK: ACR-111 16 tube receivers \$129.50, the new National Exciter units and National 600 watt transmitter kit, Signal Shifters \$39.95, \$7.50 Mac Keys at special price of \$5.95. W9ARA has the latest equipment.

Compare Bob Henry's Terms with Others

Model and Receiver	Cash Price	Down Payment	12 Monthly Payments
NC80X and NC81X.....	\$99.00	\$19.80	\$6.99
NC101X.....	129.00	25.80	9.11
RME-69.....	151.20	30.24	10.69
Bretling 14AX.....	99.00	19.80	6.99
The NEW Sky Buddy.....	29.50	5.90	2.08
Sky Champion.....	49.50	9.90	3.49
Sky Challenger II.....	77.00	15.40	5.44
Super Sky rider.....	99.00	19.80	6.99

Also Super Pro, HRO, PR15, Bretling 9, Sargents, others.

Similar terms on Harvey, RCA, RME, Temco transmitters and National, Progressive, Utah, Stancor, All Star kits.

HENRY RADIO SHOP

211 North Main Street Butler, Missouri

The 1851 in Receivers

(Continued from page 41)

its screen should be disconnected from the voltage divider and fed through a series resistor of about 60,000 ohms. The cathode resistor should be 150 ohms.

In receivers having one r.f. stage, the reduction in image ratio more than outweighs the improvement in signal-to-noise ratio when the 1851 is simply substituted for the existing tube. If the receiver construction permits, the bad features probably can be overcome by tapping the grid lead down on the coil in the first tuned circuit to reduce the loading. Although it was not possible to do this in the particular receivers tried, it seems likely that with the grid tapped at a point giving the same stage gain as with an ordinary tube connected across the whole coil, the image ratio might not be impaired—it is even possible that some improvement might result—while still maintaining the better signal-to-noise ratio. This also would reduce oscillation troubles; the higher transconductance of the tube makes it particularly likely to oscillate when simply substituted for another tube unless the input and output circuits are exceptionally well shielded.

In using the tube make sure that the builder of the receiver has not used the No. 6 socket prong as a convenient terminal for some d.c. connection in the set. This pin is absent on ordinary r.f. tubes, but in the 1851 is connected to the shield pin. In one receiver, this usually-overlooked pin very effectively killed the whole set by grounding the screen circuit, which was tied to the normally-blank No. 6 socket prong.

—GG & BG

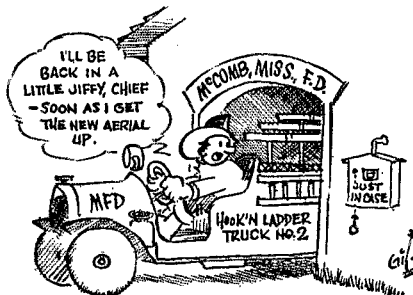

W5ECH IS A FIREMAN

YOU CAN BUY NO BETTER
RADIO AND TELEVISION
Power TRANSFORMERS
. THAN THOSE WHICH BEAR

THE NAME



THE ACME ELECTRIC & MFG. CO.
38 WATER ST. CUBA, N. Y.

Acme  Electric
TRANSFORMERS

The "Rubber Crystal"

that **REALLY WORKS!**

Meissner **SIGNAL SHIFTER**

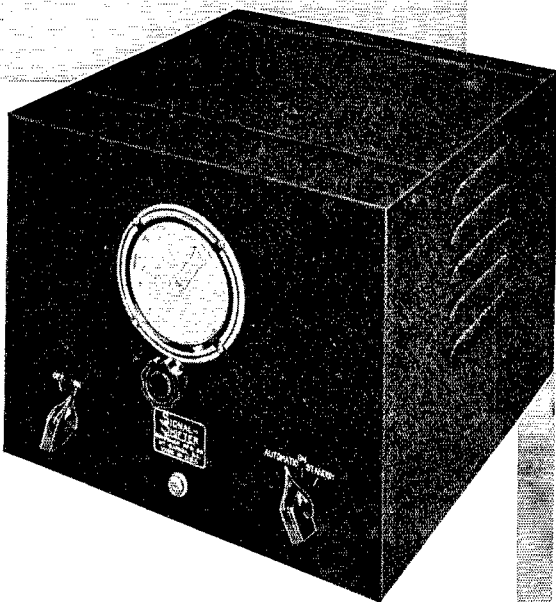

AT LAST! A remote frequency control that gets you out from under the QRM! Unbelievable frequency stability — superior to that of many crystals — obtained by use of special Hi C electron coupled oscillator circuit and dual buffer arrangement to isolate load. Rigid, fool-proof construction insures against changes due to ordinary handling and usage. Maximum variation of calibration observed during 21-day actual operation at W9WWI under varying conditions of temperature and humidity was .008% or 300 cycles at the operating frequency of 4,000,000 cycles (75 meters). Frequency shift with load variation, tested during this period, was less than 500 cycles from full-load to no-load.

Your SIGNAL SHIFTER will be handmade in the famous Meissner Laboratories by Meissner engineers. ASK YOUR PARTS JOBBER or write the factory!

- Accurate and Stable Calibration! (Dial calibrated 0-100 with vernier pointer)
- 5 Sets of Plug-in Coils Cover 10, 20, 40, 80 and 160 Meter Bands!
- Output Constant Over Entire Range of Each Band.
- Power Output More Than Sufficient to Eliminate the Use of One or Two Doubler Stages.
- Tubes Remain at Constant Operating Temperature Whether Signal Shifter is in Use or "Standing-by."

Meissner

"A FAMOUS NAME FOR TWO DECADES"

MT. CARMEL, ILLINOIS

Say You Saw It in QST — It Identifies You and Helps QST

(Continued from page 85)

when lines were broken between Hannibal and St. Louis. TFQ took traffic for the Associated Press from the L. A. flood. EYM is enjoying O.P.S. appointment. HVT is planning all-band operation. KIK turned ham reporter. LTH won a station photo contest at club meeting. HUZ has one of the highest antennas in St. Louis. UAB is using a 6L6. VMU likes 28 Mc. with an inside antenna. VMH spent a short time in hospital, but is all set to use his new Class A ticket on 3.9 Mc. GBJ made his debut on 3.5 Mc. RSO won the Maxim Memorial Award for 1937, has 70 watts and 75 countries. RJP is DXing and A.A.R.S.-ing. OMG is managing the emergency work for Poplar Bluffs. YNR has a T-55 in the offing. ZAO is working on his latest antenna lobe theory. VID is doing nicely on 1.75 Mc. with a pair of 809's final. AIJ visited A.A.R.S. Hq. at BNT in Omaha, EDI in Lincoln, FLG in Topeka and KLJ. The O.A.R.C. has a fine emergency net set-up in close cooperation with the Red Cross. TGN lost one of his little twin daughters on Easter morning. The YL's were just a year old. OUD was surprised to make B.P.L. again. That's all, folks. If you want your name in the paper, you know how to get it there.

Traffic: W9OUD 847 AIJ 175 PYF 160 EFC 27 TCM 25 RSO 6 KIK 4 GBJ 2.

NEBRASKA—SCM, Samuel C. Wallace, W9FAM—QRN and sleet storm with no power almost kept DI from making B.P.L. UHT is figuring on ham picnic in June for the western Nebr. hams. KPA plans on doing little high-frequency operating. EHW is working on new rig. SDL continues a little A.A.R.S. work. UDH is rebuilding 28-Mc. rig. MZF working on new antenna. ZFC has a good collection of real old ham equipment on display at his shack. VST reports that Northeast Radio Club held its regular meeting at TBF's. The club is sponsoring a hamfest to be held at Wayne, June 5th. Emergency net did some nice work during recent sleet storm. ZAR is newcomer on 1.75-Mc. 'phone. WGL is working DX on 28 Mc. AGH has new NC81X. ZUT blew 802. DHO in Crofton is helping a new ham get started. ZHJ visited in Topeka, Kans. RWV did some very good work during sleet storm. QFT is going strong. QWV lost antenna in wind and sleet. GFI is keeping his end of 7 Mc. going hot. YDZ needs So. Carolina and Miss. for his W.A.S. QQJ is getting out nicely. QWV is winding transformer.

Traffic: W9BNT 1032 DI 503 UHT 150 KPA 78 FAM 83 EHW 16 SDL 3 UDH 7 ZFC 20 RWV 6.

WEST GULF DIVISION

NORTHERN TEXAS—SCM, Lee Hughes, W5DXA—EOE leads the Section in traffic. DNE has a fine bunch of schedules. DXA reports T.L. "D" working fine. FMZ is very reliable net station. FRE worked T.L. "D" while FAJ awaited license renewal. BKH has new T125 final. BAM is getting ready for N.C.R. duty. FOP is using 6L6 portable on 7 Mc. FZJ is working 14 Mc. with $\frac{1}{2}$ -wave Reinartz loop in attic. ECE worked 14 new countries in 'phone DX contest. C1X, new Irdell ham, is on 1.75-Mc. 'phone. GSX worked VY. ZS has new National NC100X. EEN is operating portable 14-Mc. 'phone in Childress. AZB moved to Childress. EES is putting up 8JK flat top beam for 14 Mc. The S.C.M. had the following visitors: EOE, EOC, GKB and ZS. Fellows, when you report by radio, please give some news of your station and activities in your vicinity. Thanks.

Traffic: W5EOE 768 DNE 310 DXA 152 FMZ 106 CDU 102 FRE 90 BKH 57 BAM-GDH 14 EZY 12 FOP 11 CPT 10.

OKLAHOMA—SCM, Carter L. Simpson, W5CEZ—CEZ handled some more QRR traffic. FSK had receiver trouble, so YJ ran trunk schedules for a few days. GFT handled plenty of QRR traffic during emergency. CVA handled over 5000 words of press during emergency. DTU lost a mast in the blizzard. FRB enjoys N.C.R. work. GDT joined A.A.R.S., and is moving to Flagstaff, Ariz. EMD helped GAQ with QRR traffic. GAR handled QRR traffic. AIR shut down to rebuild rigs. HAR is new ham at Beggs. EGQ has 'phone on 3.9, 14 and 28 Mc. EHY is building new 1.75-Mc. 'phone rig. EST gets nice reports on O.B.S. Oklahoma hams again did a nice piece of work during sleet, snow and wind storm, April 7th-8th-9th, when lines were down and roads blocked.

Traffic: W5CEZ 680 WLJC 61 FSK 334 WLJY 48 EGP 327 WLJL 87 GFT 316 YJ 253 WLJO 50 FOM 182 FOJ 113 CVA 86 FRC 80 MK 64 DTU 53 FRB 40 GME 22 GDT 37 EMD 34 GAQ 20 DAK 17 FBI 11.

SOUTHERN TEXAS—SCM, Dave H. Calk, W5BHO—OW leads the Section in traffic. MN is now a member of the Hit-and-Bounce Trunk Line covering P.L., Hawaii, West Coast, East Coast and the Mississippi Valley. FDR reports for the Section Net. Active in the net are FZD, GUY, GLK, BEF, CVQ, BEH, OW, DLZ and FDR. CVQ keeps daily schedules. GNY reports the Beaumont Club building 110 volt a.c. power supply for emergency use. EWZ worked VK4SA, receiving VK4SA RST 589. DB reports for Mc-Cammy gang. DPS got a pair of T-40's going on 7 and 14 Mc. and then moved to Coleman. BYV has been in hospital. Sorry to hear you were ill, OM. FLB built new house and included a keen room for the rig "only." DB has been very active on 28-Mc. 'phone. GAG and FNE brothers are active on 7 Mc. FWN worked portable at the Petroleum Industry Electrical Association Convention in the Rice Hotel, handling traffic for the delegates to several states. The Transmitting Amateurs Association of El Paso recommended FSG for Emergency Coördinator. EVJ has new National 80X. FRK had his appendix removed. FYU is a low-power hound. GWV, new ham in El Paso, is very active on 7 Mc. HBK is new call in E.P. CWW put up 60-ft. flat top beam in hopes of working Europe on 14 Mc. BRC is moving back to his home in Houston. BKW is still building that 500-watt rig. AMX reports DX very good on 14 Mc. BTK is on vacation in New York and East. FI has 70 watts c.e. on 56 Mc. GUY keeps one schedule daily. BHO, your S.C.M., wants to meet all you fellows personally at the West Gulf Division Convention in Carlsbad, N. M., August 25th-26th-27th. We still have several vacant Emergency Coördinator positions and will be glad to receive recommendations. DLZ is open for dependable schedules on 7 or 14 Mc.

Traffic: W5OW 1370 FDR 726 MN 458 DWN 131 CVQ 80 GNY 67 GUY 34 BEF 14 DB 7 BHO 14 DLZ 185.

NEW MEXICO—SCM, Joseph M. Eldodt, W5CGJ—ENI is now N.C.S. of the A.A.R.S. How about helping your S.C.M. use up some of the space the Section is allotted in QST?

Traffic: W5ENI 337 (WLJI 3) ZM 260 (WLJG 140).

DAKOTA DIVISION

NORTH DAKOTA—SCM, Ernest Bloch, W9RZA—NYVF visited IGZ and YAP, then the three of them called on EU and HEO. QGM moved his rig from the shop to the house. ZTL is now at Carson. DM reports as follows: "Traffic total twenty plus one YL, seven and a half pounds!" Congratulations, Prof.! NZG ordered Super Skyriider. STT worked ZL and K6 on 7 Mc. STJ is also having good luck. ZRT ordered 7-Mc. crystal to get on 14 Mc. PGO, who has a job with N.W. Airlines, was transferred to Bismarck, so is back with the home gang. We're glad to hear ex-S.C.M. OFI. back on the air; he's using a 6A6 crystal, 6L6 buffer doubler and four 48's P.P.P. on 220-volt d.c. supply; the rig works all bands to 56 Mc. and will be rigged up for 'phone. BMR is rebuilding power supply and expects to be on 3.9-Mc. 'phone soon. QQY is a new call in Fargo. AEL, press op at KFJM, built a portable rig using an RK20 and '63A. Fargo hams are planning a hamfest for the 29th and 30th of May. Don't forget to bring your portable 56-Mc. equipment, as there will be a hidden transmitter hunt.

Traffic: W9AEL 19 RZA 18 BMR 6 VUG-GSG 2.

SOUTH DAKOTA—SCM, Andrew J. Kjar, W9SEB—AZR: R.M. and E.C. OXC: O.B.S. This report will be the last from SEB as your S.C.M. This finishes my two year term of office. I take this means of thanking you all for your loyal support and help you have given me to make my job easier. Let's all pitch in and help the new S.C.M. all we can. VQN is building an emergency-powered rig. FOQ has a new T-40 final on 28 Mc. Sioux Falls Club is giving code lessons to half dozen prospective hams. DIY is Assistant Director for South Dakota. ZCC is building a 56-Mc. layout. TI is rebuilding. PZI is playing with 56 Mc. to tune of 125 watts. QJJ, new ham in Howard, is using a 53-P.P. 809 rig, 90 watts. YKY is working DX on 3.5 Mc. ADJ is trying out new receivers. KNV gets out fine with the "QSL 40" rig. QAK works all bands with 6L6-6L6 rig with 16 watts and is a new member of the A.A.R.S. IQZ has 6L6-809-T55 rig and receiver built into 6-foot rack and is using grid modulation. EUH is moving to Sioux City, Iowa. SRX has T200 now. WPA built a 57-56 receiver and a 6L6 tritret for portable use. WUU put up a 257-foot center-fed Hertz. QVY has worked 11 states already. OXC, QVY and SEB visited with 5EAK, who is working portable 18 miles northwest of Pierre on a farm using a 6L6-6L6 rig with a rewound Dodge gener-

ator giving 110 volts at 1000 watts. SEB worked his first K7 an 7 Mc. FOQ is looking for Nevada for W.A.S. ZXZ is active on 3.5 and 7 Mc. Well, gang, have enjoyed writing news for our column in QST, and again thanks for your cooperation. 73 and happy landings.—Andy.

Traffic: W9AZR 299 SEB 110 VOD 20 FOQ 16 YOB 14 VQN 9 QAK 5 ZCC 4.

NORTHERN MINNESOTA—SCM, Edwin L. Wicklund, W9IGZ—HEN continues to have most of his interest in handling traffic. YCR changed '10 final to an 809. KKO bought a pair of T-40's for final and then won at club meeting. QPG and MYU are new St. Paul hams. NBH is getting some nice DX on 14 Mc. KQA blew 825, so went back to the '10. IPN puts on O.B.S., 6 p.m., 1975 kc. on week days. ZLH spends most of his time on 7 Mc. QIW made a month's tour of southern states, visiting many hams on the trip. KRG is now a papa. Congratulations. QMI is active on 7 Mc. HEO has a new YL op. Congratulations. YAP has 170 watts on 1.75-Mc. 'phone. AZE and DRK are getting 56-Mc. bug again. VVA made a two weeks' trip to the east. PTU had VTH for visitor. EU has a new 18-watt speech amp. which he will use for rig and P.A. WLK has a pair of 150-T's in final. RJF was transferred from Side Lake to the C.C.C. at Fort Snelling. The Min-Dak Radio Club had a very successful meeting at UDK in Fergus Falls; 28 hams were present. EIX is on 1.75-Mc. 'phone with his 400-watt rig. Please keep the reports coming during the summer. Best regards to all.—Ed.

Traffic: W9PTU 247 (WLUO 38) HEN 59 YCR 11 IPN 4 ZLH 2 IGZ 6 RTN 25 VTH 72 FTJ 2 VZE 1 ZYG 4.

SOUTHERN MINNESOTA—SCM, W. F. Soules, W9DCM—QDE had a good chance to work his first DX during Easter vacation and landed a K6. MZN is kept busy with five dandy schedules. ZAD is going to replace his '10 final with a T-20. YNQ says 3.5 Mc. is pretty good now, as he worked a CM2 and three YL's. At the last meeting of the Minneapolis Radio Club a very interesting discussion was held in regards to notifying the director of their wishes and also a discussion of the work of the Planning Committee. More discussions of this type should be held in order to let your director know your wishes. NYH, a new ham, is on with an 802. DCM told the members of the Mpls. Radio Club to be careful in attaching antennas to power company poles; as several ham antennas have been observed to be in very hazardous positions in regards to high voltage lines. A word of caution might be wise for any ham to keep away from the tops of power company poles. GFH is a radio operator for Pan American Airways in Brownsville, Texas. PJA visited ex-FMA, who is now 6CHI. BUO has a new way of curing B.C.L. trouble—he screws the trimmer condensers down tight on the offending receiver. DCM rejoined the A.A.R.S. ZMQ has been trying to encourage the gang on 1.75-Mc. 'phone to join the A.R.R.L. More power to him, and I hope you follow his suggestion.

Traffic: W9YNQ 32 MZN 9 ZAD 5 TKX 4 DCM 3.

ROCKY MOUNTAIN DIVISION

COLORADO—SCM, Glen R. Glasscock, W9FA—RVW took a few days out to revamp the rig. ESA hits the high spots again on traffic. Eddie denies the rumor about his escapade on 3.9-Mc. 'phone, saying he will stick to 56 Mc. for his 'phone work. 7BMY-9 just received his new call which is KAD. TDR keeps the rigs going at the airport and then comes home to daily schedules with three or four stations! YFM, SPU and YFH cleared the Class "A" exam a couple of weeks ago, and SPU jumped to a 3.9 Mc. right away. WVZ is really going to town with his new rig on the top of the divide. MXM is busy with a 56-Mc. portable outfit for summer use. RTQ was recently hitched to Marjorie Art. Congrats, Cecil! PWO had a fire at his place during the month and it messed things up quite a bit. Chas. is rebuilding his rig and in the meantime is handling N.C.R. drills via PPU's rig. EHC is active on all bands from 28 to 1.75 Mc. FXQ works low-power 1.75-Mc. rag-chew net, and brags about the new YL opr. HDU went in heavy on the DX Contest. HHD is new ham in the Springs, active on 1.75-Mc. 'phone. JWC, another new ham there, is active on 7-Mc. c.w. and 1.75-Mc. 'phone. LFE has trouble getting the T55 neutralized and uses the T20 instead. NHI is building a new rig. NRZ sold his rig to a pre-war ham who has the yen again. OAR, new ham, is working with an e.c. outfit. OKY, the P.P.A.R.A. station, traded off the ACGS and now has an AC-R-155. The club is sponsoring a contest to see which member can work the greatest number of stations from the club station. TFF bought a new house,

material for a modulator, and parts for a flat-top beam. UEK is active on the 1.75-Mc. 'phone net. VEN pounds brass at the club station. WXK is all set to take the Class "A" exam. YAE burned out another 242A and has sworn off high power. YLT is active on 7 and 3.5 Mc. YZS is on 1.75-Mc. 'phone now and then. ZCX works all sorts of DX with the greatest of ease, as well as taking part in the Sunday morning 1.75-Mc. 'phone rag-chews. ZFM gave the T55 a good workout during spring vacation. ZIZ is working on a new modulator. ZKM is packing up to move out of town. ZXU is putting up a new antenna. The 1.75-Mc. low-power rag-chew net around Colorado Springs is going strong, with most of the gang using around 3 to 5 watts. Very good signals are reported up to 30 or 40 miles during the Sunday morning meetings. H. B. Riblet, one of the opr's at KLZ, worked 3 KA's, 10 VK's, and 7 ZL's on 28 Mc. using the BC station emergency antennae. KAK is new ham in Denver. JWJ is building a portable to take to "Y" camp this summer. ZNN has a new Breting receiver and is moving his rig into a metal cabinet. QOE is building a 100TH P.P. final. UZP is having a good time on 28 Mc. QXJ is a new local Denver man to take up 28 Mc. seriously. MHN is rebuilding to handle 28, 14 and 1.75-Mc. band-switching in the rig. FUH is changing his final to use a pair of 250TH's (999 watts). AUJ is recovering from his trip to the hospital. EMU is back in Denver. NWW is on again with a new 90-watt rig. SBB applied for O.R.S. CAA joined the Emergency Corps. WJJ applied for O.P.S. OUI is delving into the mysteries of stable e.c. oscillators. GBQ is still experimenting with antenna, Vee's, vertical, etc., etc. QBI, the N.C.R. headquarters station in Denver, is taking on a better appearance, with walls newly painted, operating tables installed, and new rig under construction. Credit for majority of the work goes to BYY, MKN, BTO, FYY, ELS and 9DSB, with occasional assistance by RRS, RDI, IFA, MXA and several others. MCB is a new member of the Denver N.C.R. gang and is an ex-service man. Anyone wanting information about joining the N.C.R. can contact MKN, GLL or FA. Those interested in the A.A.R.S., contact ESA, and those interested in the 1.75-Mc. A.A.R.S. 'Phone Net, contact DDF. Those interested in O.R.S., O.P.S., O.O., O.B.S., and A.E.C. should get in touch with the S.C.M. Get into something, fellows, and push hard. It's the way to really get something out of this hobby of ours. Just because it's getting warm weather, don't let up on the reports. The u.h.f. activity this time of the year should prove very interesting. OK2PN on 14,050 and 14,250 kc. needs contact with Colorado for W.A.S. Watch for him, gang.

Traffic: W9ESA 614 RVW 334 LQO 144 TDR 116 WVZ 92 WWB 55 MKN 52 SBB 28 ECU 24 ZDZ 22 WZI 17.

UTAH-WYOMING—SCM, Townsend J. Rigby, W7COH—7AMU resigned as A.A.R.S. S.N.C.S., Wyo. Sorry to lose you, LD. You have certainly done your duty and deserve all credit for keeping this Wyo. A.A.R.S. gang together. 7AEC gets on Monday nights for A.A.R.S. 7HX gets on for schedules with AXG. 1.75-Mc. 'phone and A.A.R.S. drills. 7DIE takes over S.N.C. job! Good luck to you, Jack. 7CBL keeps one regular schedule as D.N.C.S. 2nd Wyo. A.A.R.S. 7ADF works some DX. 7DES works plenty of DX. 7ABO worked the S.C.M.; glad to hear that old speed fist again! 7AAT gets on as D.N.C.S. first Wyo. A.A.R.S. 7COX, Mrs. 7AAT, is heard occasionally. 7GFB gets on rag-chews and A.A.R.S. drills. 7FTE has a fine fist. 7LE is heard occasionally on 7 Mc. 7EVN is busy with A.E.C. and is doing an FB job in Casper. 7COV is still on 14-Mc. 'phone. 7GUX, a new ham in Midwest, will be on the air on 7 and 3.5 Mc. with 60-60 watts. 7GHF is about to go on 14-Mc. 'phone. 7GOH is active on 28 and 14-Mc. 'phone and 7-Mc. c.w. 7GLG gets a few rag-chews on 3.5 Mc. 60WV has new bug and is sure going to town with it. 6PGH has worked 16 states and some VE's. 6PQC, new ham, is active on 7 Mc. mostly. 60KF has R.C.C. certificate. 61YTB has worked 85 countries, last few being VP6YB, PK4JD, VS2AK on 'phone, F18AC and CR7AK on c.w., 14 Mc. He made W.A.C. in 2 hrs. on 14 Mc. between 1:50 p.m. and 1:50 a.m. 6 FYR makes the B.P.L. again! 6BLE has finished his radio room, and it is a shack of which any ham could be proud. 6LLH added a T240 to his rig. 6PJX is new Utah ham in Coalville. Welcome to our gang, OML. 6NPU made W.A.C.; 6LLH says it's first in Northern Utah to his knowledge. The O.A.R.O. Club has had its spring dinner for the OW's, YL's and XYL's, and everyone had a good time!

meet a coupla' BEAVERS!

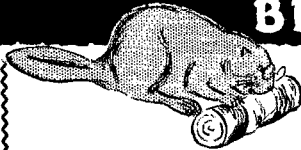

The one on the left is Johnny Beaver. Just about the busiest little guy in the Animal Kingdom. No job

is too big for him... no quarters too small. That's why we named our new condenser, Type BR, the BEAVER. It's the smallest filter capacitor on record... 1/8 the size of corresponding types. It has everything you'd expect in the latest etched foil electrolytic, and on top of that — fits into the most confined spaces.

AND AT NEW LOW PRICES!

4 MFD. 250V.
ONLY
1 3/16" LONG



Get the new C-D BEAVER for your rig now. Capacities 4, 8, 12, 16, 20 and 40 mfd., 150 volts, D.C. and up to 8 mfd., 450 volts D.C. Write for FREE catalog No. 155A to 1013 Hamilton Blvd., So. Plainfield, N. J. Cable Address: "Cordu"

CORNELL - DUBILIER



ELECTRIC CORPORATION

South Plainfield, New Jersey

PRACTICAL RADIO ENGINEERING



Don't "sit down" on the job! Get busy and prepare yourself for the bigger jobs in store for technically-trained men. A post card brings you our 48-page book of interesting facts about your future in Radio.

SEND FOR FREE CATALOGUE

Dept. Q-6, 14th & Park Road, Washington, D. C.

CAPITOL RADIO ENGINEERING INSTITUTE

PRECISION CRYSTALS

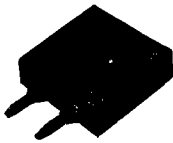

Crystal Holder

Highest quality crystals, one inch square, carefully ground for frequency stability and maximum output. Be sure of your transmitter frequency — use PRECISION CRYSTALS.

Crystals can be furnished with square holder as illustrated (fits G.R. type jacks) or with round holder to plug into tube socket. When ordering be sure to state the type holder desired. G.R. jacks to plug illustrated holder into — 15c pair.

Low frequency drift crystals (Type LTC) supplied within 0.1% of your specified frequency and calibrated to within 0.03% are priced as follows: 1750, 3500 and 7000 kc. bands \$3.50 each. Holder \$1.00. (State type desired.)

'X' cut PRECISION Crystals carefully ground for maximum power supplied within 0.1% of your specified frequency and calibrated to within 0.03% are priced as follows: 1750, 3500 and 7000 kc. bands — \$3.00 each. Holder \$1.00. (State type desired.)

'AT' cut crystals for commercial use quoted on at your request. When ordering our product you are assured of the finest obtainable. Now in our ninth year of business.

PRECISION PIEZO SERVICE

427 Asia Street

Baton Rouge, La.

Strays

Marker Stations

Through the courtesy of Mr. C. E. Pfautz of the RCA Frequency Bureau, we have been furnished the following list of regularly-operated commercial stations which are dependable markers for frequency-checking purposes. The actual frequencies of all stations listed are maintained within 0.02% of the frequencies shown:

6980—HPC	13,960—KIWA
6990—WAR	13,980—PZE
7320—JAU	14,410—DOT
7332.5—DLC	14,415—GMR
7355—KMQ, WBS-1	26,400—W9XAZ
7370—KEQ, KIKE	31,600—W1XKB
7380—XDB	31,700—W2XS



Glacier Park Convention

(Continued from page 20)

this second affair. The location is 12 miles from Glacier Park Hotel at the eastern entrance to Glacier National Park. Those planning the trip should bring their own camping equipment and provisions, unless they wish to stop at some nearby hotels or tourist camps in the park. The camp is equipped with a public laundry, hot and cold showers, modern toilets and wash rooms, a large amphitheatre for the evening camp fire lecture and community singing. Drop a note to Dr. J. Arthur Lamb, W7ABT, Conrad Bank Building, Kalispell, Mont., and he will gladly furnish further information.

SPEED-X

The Complete Line of Telegraph Keys
"HI-SPEED"
Semi-Automatic Key

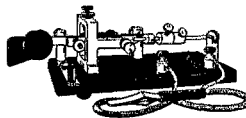

Model No. 510

Complete with switch cord and plug. List price \$10.75. Other models from \$9.25 to \$17.50. Available at leading jobbers everywhere. Write for new literature and Amateur Discounts.

Will see you in 104 Watt Ave. at the Chicago Show

LES LOGAN COMPANY

646 Jessie Street

San Francisco

Make NEWARK YOUR HEADQUARTERS

for Power Transmitting

TUBES

Taylor Tubes

T-40	\$3.50	T-55	\$7.00
TZ-40	3.50	203Z	6.00
New 805	13.50	845	12.50
T-125	13.50	822	18.50
T-200	21.50	814	18.50
T-20	2.25	211	12.50
TZ-20	2.25	806	1.50

RCA TUBES

809	\$2.50	803	\$34.50
808	7.75	804	15.00
814	17.50	805	13.50
807	3.50	806	22.00
866	1.50	913	4.00
866A	4.00	906	13.50
802	3.50	902 NEW	7.50

RAYTHEON TUBES

RK11	\$2.50	RK52	\$8.00
RK12	2.50	RK49	2.10
RK51	8.00	RK20A	15.00

EIMAC TUBES

RX21	\$7.50
KY21	10.00
35T	6.00
100TH	13.50
250TH	24.50
450TH	75.00
750TH	175.00

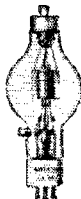

**Complete
Line**

All other numbers
not listed are
always
Carried in Stock

Oil Filled, Oil Impregnated

FILTER CONDENSERS

\$1 1500 V. DC
ONLY 1 1/2 mfd.

2" Diameter Round Can
2 3/4" high. Weight 1/2 lb.

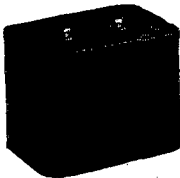

WELL KNOWN MAKES.
Guaranteed at rated voltages.
We've sold 10,000 at these low
prices... then bought MORE
at a lucky price! Quantities
limited. First come, first served.

2 mfd., 2000 V. DC	4 3/4 x 3 3/4 x 1 3/4, 1 1/2 lbs.	\$1.50
3 mfd., 1000 V. DC	5 x 3 3/4 x 1 3/4, 1 1/2 lbs.	1.10
3 mfd., 1250 V. DC	5 x 3 3/4 x 1 3/4, 1 1/2 lbs.	1.25
3 mfd., 1500 V. DC	5 x 3 3/4 x 1 3/4, 1 1/2 lbs.	1.50
4.4 mfd., 1500 V. DC	5 x 3 3/4 x 1 3/4, 1 1/2 lbs.	1.75
8 mfd., 2000 V. DC	5 x 3 3/4 x 3 3/4, 2 1/2 lbs.	2.75
10 mfd., 750 V. DC	4 3/4 x 4 3/4 x 1 1/2, 2 lbs.	1.75
14 mfd., 750 V. DC	4 3/4 x 4 3/4 x 1 1/2, 2 lbs.	2.00

Just Out, WRITE QUICK!

FOR FREE BULLETIN

Big Bargains in Parts and Supplies.
Easy Terms on all orders \$60.00 or more.
Big Illustrated Catalog free upon request.
Mention your Call Letters when you write

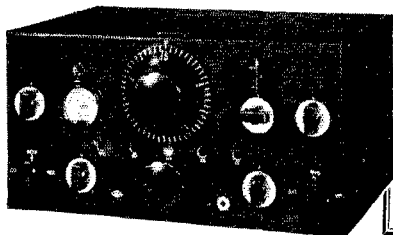

WITH
R-METER

NEW National's Newest! **\$24.00**
Wide Band Spread!
NC-101X DOWN

Only \$9.47 Per month and A Year to Pay!

(Or \$12.50 per month for 9 months or \$18.58 per month for 6 months)

Designed strictly for amateur bands. Provides all necessary features required by this specialized field. One R.F. and two I.F. stages. 11 tubes. Single Signal crystal standard equipment. Separate controls for Selectivity, Phasing, R.F. Gain, Audio Gain, Tone, C.W. Oscillator and AVC. R-METER.

Quick band change by same coil-shifting mechanism as in NC-100. Each of the five Amateur bands are spread over 400 divisions on Dial. Special S.F.L. condenser plater: double spaced, insure exceptionally low temperature drift. The receiver (self contained except for speaker) may be readily converted for relay rack mounting with brackets.

Look! Complete with all these Features!

- Five band spread ranges: 1.7-2.0 Mc., 3.5-4.0 Mc., 7.0-7.3 Mc., 14.0-14.4 Mc., 28.0-30.0 Mc.
- Strictly single control tuning.
- Automatic plug-in coils.
- Micrometer dial.
- R-Meter.
- Amplified, delayed AVC.
- C.W. Oscillator.
- Crystal Filter.
- Two I.F. stages, 11 tubes.
- Power output 10 watts.
- Built in power supply, 10" dynamic speaker.

Type NC-101X — Receiver — complete with tubes, power supply and 10" dynamic speaker chassis. Cash price, \$129.00
Type RRA — Relay Rack Adapters. Price, per pair, \$1.50

Order Today Direct from this Ad. Send Down Payment and Mention Your Call Letters

AS LOW AS \$19.00 DOWN

ACCORDING TO THE SET YOU BUY

EASY PAYMENTS \$7.30 to \$38.08 MONTHLY

These receivers are among the best values money can buy. Our 6% EASY CREDIT PLAN makes it easy to own one. Compare our rates. Send down payment with your order today. Set will be shipped as soon as credit is O.K.'d. Entire transaction 1 week. Order now!

	Cash	Down	6 Months	9 Months	12 Months
	Price	Payment	Payments	Payments	Payments

NATIONAL NC-80X-NC-81X complete with Tubes, Crystal, and 8 in. P.M. Speaker.	\$99.00	\$19.00	\$14.36	\$9.66	\$7.30
NATIONAL NC-100X complete with tubes, crystal and speaker in cabinet.	\$147.60	\$27.60	\$21.10	\$14.21	\$10.80
NATIONAL NC-100 complete with tubes and speaker in cabinet.	\$125.10	\$20.10	\$18.58	\$12.50	\$9.47
NATIONAL NC-101X complete with tubes, crystal and speaker.	\$129.00	\$24.00	\$18.58	\$12.50	\$9.47
NATIONAL HRO with tubes and coils.	\$179.70	\$29.70	\$26.14	\$17.67	\$13.45
NATIONAL HRO with tubes, coils and power supply.	\$195.60	\$35.60	\$27.84	\$18.83	\$14.33
RME-69 complete with tubes, crystal and speaker in cabinet.	\$151.20	\$26.20	\$21.94	\$14.77	\$11.25
HAMMARLUND SUPER PRO complete with tubes and 8" dynamic speaker.					
Model SP-110 — 15 to 560 meters and Model SP-110S — 7.5 to 240 meters.	\$243.00	\$33.00	\$36.35	\$24.61	\$18.75
Model SP-110X — 15 to 560 meters and Model SP-110SX — 7.5 to 240 meters.	\$261.00	\$41.00	\$38.08	\$25.78	\$19.64
HALLIGRAFTER SKY CHALLENGER II complete with tubes, crystal and speaker.	\$99.00	\$19.00	\$14.36	\$9.66	\$7.30
HALLIGRAFTER SX-16 SUPER SKY RIDER complete with tubes, crystal and speaker.	\$123.00	\$23.00	\$17.74	\$11.93	\$9.02
HALLIGRAFTER SX-17 SUPER SKY RIDER complete with tubes, crystal and speaker.	\$149.50	\$34.50	\$20.26	\$13.64	\$10.36

NEW LOW PRICE on RCA-ACR-111 Now \$129.50
(Originally \$189.50) Only

\$24.50 Down! Pay only \$9.47 per month for 12 months; \$12.50 per month for 9 months; or \$18.50 per month for only 6 months! You save \$60 at this new low price!

NEWARK

Electric Company

323 W. MADISON ST.
Dept. Q CHICAGO, ILL.

WHEN WE SAY

' LIGHTNING '

We're thinking of that funny stuff that comes zooming out of the skies, right through the QRM, lighting up everything in a flash!

AND WHEN WE SAY

LIGHTNING CALCULATORS

We mean that these gadgets bring an answer right through *mathematical QRM* just like that — in a clear flash!

Type A, \$1.00 Type B, \$1.00

For problems involving frequency, inductance and capacity, in design of radio frequency circuits. Direct reading answers for size of coils and condensers for any range between 400 kc. and 150 mc.

Gives direct reading answers to calculations involving current, resistance, voltage and power with scale for resistance of copper wire and scale for calculating decibel gain or loss.

Type C, \$.50 Type D, \$.50

More information on electrical conductors than you could find in a book full of tables.

Gives decibel gain or loss when input and output voltages, currents or power are known.

Type E, \$.50 Type F, \$.50

Direct reading total resistance of resistors connected in parallel, and total capacity of condensers connected in series.

Permits measurement of resistance, from 1 ohm to 1 megohm by use of a voltmeter. Makes an ohm-meter of your voltmeter.

Prices include postage from the
AMERICAN RADIO RELAY LEAGUE
West Hartford, Connecticut

Silent Keys

It is with deep regret that we record the passing of these amateurs:

Arthur L. Ballou, W1DLL, Uxbridge, Mass.

Preston Berry, W2EJP, Long Island City, N. Y.

I. E. Ettinger, W2BJP, Monsey, N. Y.

Earl T. Hatch, W7EDO, Seattle, Wash.

Joseph C. Kuhn, W9HBQ, Louisville, Ky.

A. A. McCue, K7AAC, Seattle, Wash.

Sumner W. Sears, W1EBK, Leominster, Mass.

Ray C. Walker, W9MZQ, Beatrice, Neb.

Circulation Statement

PUBLISHER'S STATEMENT OF CIRCULATION AS GIVEN TO STANDARD RATE AND DATA SERVICE

This is to certify that the average circulation per issue of QST for the six months' period July 1st to and including December 31, 1937, was as follows:

Copies sold.....	41,724
Copies distributed free.....	460

Total..... 42,184

K. B. Warner, Business Manager

D. H. Houghton, Circulation Manager

Subscribed to and sworn before me

on this 11th day of March, 1938

Alice V. Scanlan, Notary Public

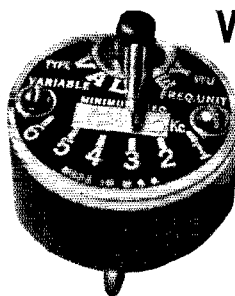

Variable Frequency

The new type VFU unit employs a low drift highly active crystal, mounted in our new molded holder designed for tube socket mounting. Fundamental frequency variation up to, and over, 6 Kc's.

Supplied within 5 Kc's of minimum specified frequency, in the 3.5 Mc band, or from dealer's stock.....\$5.95

Exact specified frequency.. 7.50

Our new eight-page catalogue is ready, obtain a copy from your dealer or write direct.

The Valpey Crystals

Box 321

HOLLISTON, MASS.

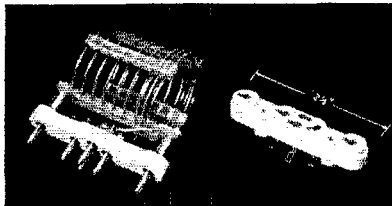
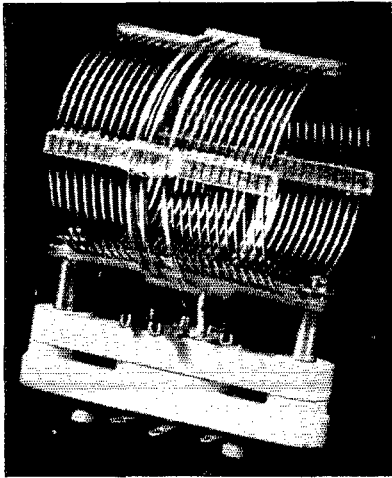

SMALL PLUG-IN INDUCTORS

Victron insulation, good form factor, and air-spaced bare copper windings give these new coils a high efficiency that makes them ideal for use in buffers, exciters, doublers, and low-power finals. Their compact size (about 1½" diameter and about 1½" length) adapts them to crowded layouts and portables. The Isolantite plug-in base permits quick and easy band changing. They are available for either push-pull or single stages up to 25 watts and for all amateur bands. A blank unglazed Isolantite coil form (1¼" diameter and 2¾" long) also fits the same mountings. The 5-prong plug-in base and coil-form may be purchased separately.

NATIONAL COMPANY, INC.
Malden, Mass.

SPECIAL TO AMATEURS

Piezo-Electric Crystals — \$2.50 EACH POSTPAID

Until supply is exhausted . . . we offer 80 meter band crystals unmounted; accurate calibration, excellent oscillators. Limited quantity.

SCIENTIFIC RADIO SERVICE

"The Crystal Specialists Since 1925." University Park, Hyattsville, Md.

RADIO ENGINEERING



RCA Institutes offer an intensive course of high standard embracing all phases of Radio and Television. Practical training with modern equipment at New York and Chicago schools. Also specialized courses and Home Study Courses under "No obligation" plan.

Illustrated Catalog on request

RCA INSTITUTES, INC. Dept. ST-38

A Radio Corporation of America Service

75 Varick St., New York 1154 Merchandise Mart, Chicago

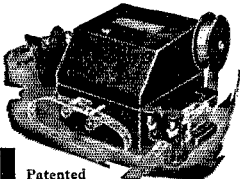

At Last!
A Perfected
**AUTOMATIC
SENDER**

Patented

Save your fist. Let the Automatic Sender raise your stations for you. Repeats calls or messages indefinitely. Length of messages practically unlimited. Sends from 2 to 70 words a minute. Motor driven. Entirely automatic. Built-in tape perforator. Absolute uniformity in spacing of characters. Used with buzzer or oscillator, makes excellent code teacher for novice and speed-builder for the advanced amateur. Complete with 4 rolls of tape and full instructions. No extra equipment needed. If your dealer can't supply you, write us.

FULLY GUARANTEED

\$12.50

\$13.50
West of
Denver

Postpaid
in U. S. A.

Gardiner-Levering Co. Haddon Heights
New Jersey, U. S. A.

Get Yours
TODAY

The New
RADIO

Antenna

75¢

HANDBOOK

A kilowatt won't go far with a poor antenna, but with a good one you can transmit long distances with one watt.

This new 112-page book is devoted entirely to antennas and feeders. 136 illustrations and diagrams. Many tables of dimensions make calculations unnecessary. All practical rotary arrays and directive antennas as well as several "multi-banders" are covered in detail.

75c postpaid in continental U.S.A.; elsewhere, 85c. Canadian postal notes and British postal orders (3/6) acceptable.

RADIO, LTD., 7460 Beverly Blvd., Los Angeles

ON SALE AT ALL DEALERS



FOR
BOTH
AC
AND
DC
TESTING
USE

Model 666
DEALER PRICE
\$15.00

Pocket Volt-Ohm-Milliammeter

Uses large 3" sq. Triplet Instrument. Has molded case, selector switch and all necessary accessories. A complete instrument for voltage, current and resistance analyses. Size — 3 1/8" x 5 7/8" x 2 1/4". See Your Jobber — Write for Catalog.

The Triplet Electrical Instrument Co.
256 Harmon Dr., Bluffton, Ohio

Please send me more information on Model 666.
Name.....
Address.....
City.....State.....

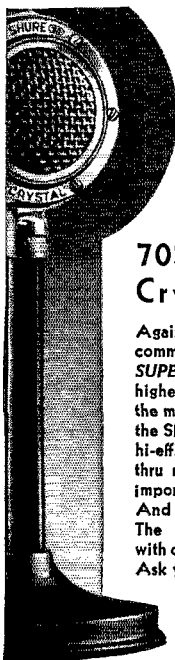

NEW ★
**SUPER
LEVEL**

70SW Communications Crystal Microphone

Again — Shure Engineers bring you a better communications-type microphone — a SUPER-LEVEL 70SW that gives you the highest output of any crystal microphone on the market. It retains all the features that made the Shure 70S world-famous — gives you the hi-efficiency speech characteristic that cuts thru noise and static — doubles power on important intelligibility speech frequencies. And you don't need as much amplifier gain! The Model 70SW Super-Level, complete with desk stand and cable, lists at. . . . **\$25** Ask your Jobber or Write for Catalog 150Q.

Shure Patents Pending. Licensed under patents of the Brush Development Company.



A.R.R.L. QSL Bureau

FOR the convenience of its members, the League maintains a QSL-card forwarding system which operates through volunteer "District QSL Managers" in each of the nine United States and five Canadian districts. In order to secure such foreign cards as may be received for you, send your district manager a standard No. 10 stamped envelope. If you have reason to expect a considerable number of cards, put on an extra stamp so that it has a total of six-cents postage. Your own name and address go in the customary place on the face, and *your station call should be printed prominently in the upper left-hand corner.*

- W1—J. T. Steiger, W1BGY, 35 Call Street, Williamsett, Mass.
- W2—H. W. Yahnel, W2SN, Lake Ave., Helmetta, N. J.
- W3—R. E. Macomber, W3CZE, 418 10th St., N. W., Washington, D. C.
- W4—G. W. Hoke, W4DYB, 328 Mell Ave., N. E., Atlanta, Ga.
- W5—E. H. Treadaway, W5DKR, 2749 Myrtle St., New Orleans, La.
- W6—Horace Greer, W6TI, 414 Fairmount Ave., Oakland, Calif.
- W7—Frank E. Pratt, W7DXZ, 5023 So. Ferry St., Tacoma, Wash.
- W8—F. W. Allen, W8GER, 324 Richmond Ave., Dayton, Ohio.
- W9—Roy W. McCarty, W9KA, 11 South Michigan Ave., Villa Park, Ill.
- VE1—J. E. Roue, VE1FB, 84 Spring Garden Rd., Halifax, N. S.
- VE2—C. W. Skarstedt, VE2DR, 236 Elm Ave., Westmount, P. Q.
- VE3—Bert Knowles, VE3QB, Lanark, Ont.
- VE4—George Behrends, VE4RO, 186 Oakdean Blvd., St. James, Winnipeg, Manitoba.
- VE5—H. R. Hough, VE5HR, 1785 First St., Victoria, B. C.
- K4—F. McCown, K4RJ, Family Court 7, San-turce, Puerto Rico.
- K5—Norman F. Miller, K5AF, 15th Air Base Squadron, Albrook Field, Canal Zone.
- K6—James F. Pa., K6LBH, 1416D Lunalilo St., Honolulu, T. H.
- K7—Dean Williams, K7ELM, Box 2373, Juneau, Alaska.
- KA—George L. Rickard, KA1GR, P. O. Box 849, Manila, P. I.



"Calling Car 23...Car 23"

Car 23 is being called in to show you the new Harvey 2-way Police Radio installation. This transmitter-receiver equipment is licensed under patents of the American Telephone & Telegraph Co., for use in Police and Fire Services. Small departments as well as large can now take advantage of this 2-way equipment because it is inex-

pensive — easy to install — low maintenance cost — standard parts — crystal controlled transmitter and receiver — meets every requirement of the Federal Communications Commission. For complete details write to Harvey Radio Laboratories, Inc., 25 Thorndike Street, Cambridge, Mass.

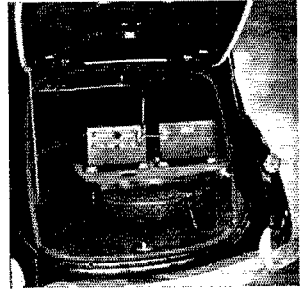

HARVEY 2-way POLICE RADIO

GAMMATRON

THE 354
\$24.50
150 watt
tantalum plate

THE 254
\$12.50
100 watt
tantalum plate

THE 54
\$6.75
50 watt
tantalum plate

**QUALITY
TO FIT EVERY
AMATEUR
PURSE**

PRICES OF OTHER
GAMMATRONS ON REQUEST

HEINTZ AND KAUFMAN
SOUTH SAN FRANCISCO LTD CALIFORNIA U. S. A.

MEMBERSHIP SUPPLIES

Available only to A.R.R.L. Members

INSIGNIA OF THE RADIO AMATEUR

In the January, 1920 issue of *QST* there appeared an editorial requesting suggestions for the design of an A.R.R.L. emblem — a device whereby every amateur could know his brother amateur when they met, an insignia he could wear proudly wherever he went. There was need for such a device. The post-war boom of amateur radio brought thousands of new amateurs on the air, many of whom were neighbors but did not know each other. In the July, 1920 issue the design was announced — the familiar diamond that greets you everywhere in Ham Radio — adopted by the Board of Directors at its annual meeting. It met with universal acceptance and use. For years it has been the unchallenged emblem of amateur radio, found wherever amateurs gathered, a symbol of the traditional greatness of that which we call Amateur Spirit — treasured, revered, idealized.

Do You
Wear the
A.R.R.L.
Pin?

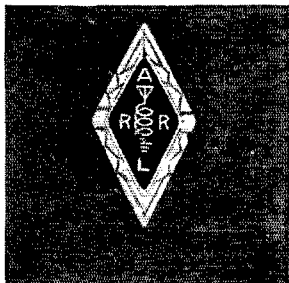

THE LEAGUE EMBLEM, with both gold border and lettering, and with black enamel background, is available in either pin (with safety clasp) or screw-back button type.

In addition, there are special colors for Communications Department appointees.

- Red enameled background for the SCM.
- Blue enameled background for the QRS or OPS. (Red available in pin type only. Blue may be had in either pin or button style.)

THE EMBLEM CUT: A mounted printing electrotype, 5/8" high, for use by members on amateur printed matter, letterheads, cards, etc.

ALL EMBLEMS PRICED THE SAME

50c postpaid

STATIONERY

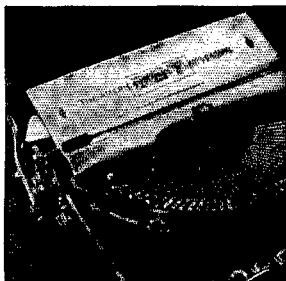

Members' stationery is standard 8 1/2 x 11 bond paper which every member should be proud to use for his radio correspondence. Lithographed on 8 1/2 x 11 heavy bond paper.

100 Sheets,
50c
250 Sheets,
\$1.00
500 Sheets,
\$1.75
Postpaid

THE AMERICAN RADIO RELAY LEAGUE
WEST HARTFORD, CONNECTICUT

New Products

High-Voltage Keying Relay

A NEW keying relay with high voltage insulation has just been announced by the Ward Leonard Electric Company. This relay was developed for grid-controlled rectifier tubes such as the Eimac KY 21 and the Sheldon KY 866 in such circuits as those of page 34, February *QST*.

The type 507-516 keying relay has single pole, normally open, double break contacts. It has a bakelite cross-arm and is mounted on a bakelite base.

Light weight parts are used in the armature assembly, providing speed in keying up to 50 words per minute.

Contacts are silver-to-silver, insulated at 5000 volts to ground. The relay operates at 6 to 8 volts d.c.

New Glow-Discharge Remote Control Tube

A COLD-CATHODE glow-discharge tube designated as Gas-Triode OA4G is a recent addition to the RCA receiving tube line.

The OA4G is intended primarily for service as a relay tube and is designed especially for use in an electrical system for the remote tuning and control of line-operated radio receivers. It can be actuated by r.f. impulses generated under the control of the user and transmitted over the power line that supplies the radio receiver. Only a small amount of electrical energy is required to actuate the OA4G. Being of the cold-cathode type, it does not consume power when the remote control is not in use. A remote-control system using the OA4G provides a simple method for eliminating special cables and gives the user a large choice of control positions.

The remote-control capabilities of the OA4G can be utilized by amateurs in numerous ways.

Book Review

How to Pass Radio License Examinations, by Charles H. Drew. 201 pages, 73 diagrams and illustrations. Published by John Wiley & Sons, Inc., New York. Price, \$2.00.

The new edition of this text, which has in its way become a classic, is revised in terms of modern practice and contains regulatory changes up through April 1, 1938. Its accuracy can, in general, probably be relied upon for some time to come, therefore.

The book is the commercial equivalent of the A.R.R.L. *License Manual*, containing typical question-and-answer data on the material to be encountered in the examinations for the various commercial operator license classifications. It will not provide the basic education necessary to pass the more advanced examinations; this is left to the standard radio theory texts. It does, however, provide the essential information required to write an accurate and intelligent

TOPS IN CRYSTAL CONTROL

WHAT do you expect when you buy your quartz crystals? Accurate Calibration? High Activity? Dependability? Single Frequency Oscillation? Stability?

Experienced amateurs want *all* of these characteristics—and get them by using Bliley Crystal Units. They know that there is no substitute for exact engineering, thoroughness in every detail, and rigid tests throughout each manufacturing operation.

Whichever band or bands you work, there's a Bliley Crystal Unit to suit your particular requirements. The Type LD2 for 80 and 160-meters, the new Type B5 for 40 and 20-meters, and the Type HF2 for 20 and 10-meters are all "tops" in crystal control. Bliley Electric Co., Erie, Pa.

Be sure to read "Frequency Control with Quartz Crystals" 10¢ at Bliley dealers (15¢ Canada)

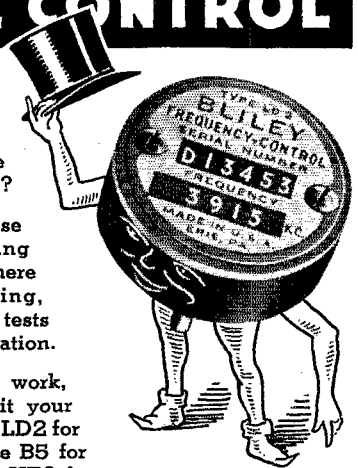
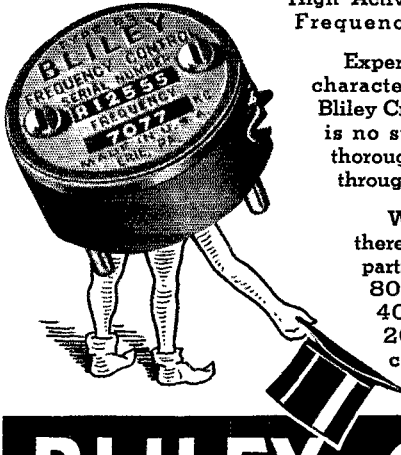

BLILEY CRYSTAL UNITS

LEARN CODE RIGHT

INSTRUCTOGRAPH tapes send you typical messages Radio or Morse any speed. Easy practical way to improve. Senior Model \$20.25 (also rented). Junior Model \$12.00 (not rented). Complete oscillator equipment less battery \$6.50. Write for details today.

INSTRUCTOGRAPH CO., Dept. Q-6
912 Lakeside Place Chicago, Ill.



SICKLES COILS

ALL TYPES OF RF AND IF WINDINGS

Manufactured by

F. W. SICKLES COMPANY

300 Main Street

Springfield, Mass.

Radio Operator's
Course
Telegraphy—
Telephony
Aviation

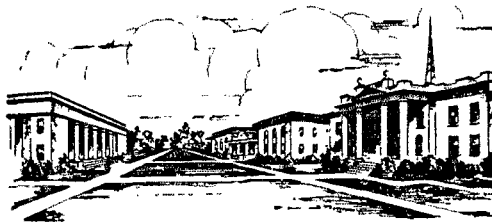

Practical
Experience
Studio—
Transmitter—
Announcing

PORT ARTHUR COLLEGE has been teaching Radio for twenty-eight years, and during this time it has never been our policy to guarantee positions to prospective students, directly or indirectly. We believe it wisdom at this time, however, to go on record in our *QST* advertising to say that it is impossible for us to even come near to supplying the demand for Radio Operators received by our Employment Department. We do not mean by this that all students who enroll will automatically secure positions. The demand is for graduates—good men who deserve and are qualified to hold positions. The graduates of our Radio School, so far as we know or can learn, are employed 100%.

It is possible for every student who enters the P. A. C. Radio School and completes the course in keeping with our standards to receive employment as a Radio Operator for our station

K P A C at the transmitter, in the control room, as trans-radio press operator, or announcer, and not only earn more money than he pays for the training but to also continue his training as a post-graduate student in advanced work and prepare himself to secure and hold operating positions in the upper bracket of broadcasting, marine work, announcing, or airways.

Port Arthur College advertises primarily to Radio Amateurs and the training is too technical for the average student who has not selected Radio as his life's work. We know the opportunities for positions and advancement are unlimited for men who are interested in Radio and who plan to make this their career and are willing to make the sacrifice and effort necessary to master our training. P. A. C. maintains strict collegiate rank—only high school or college graduates are eligible for enrollment.

If interested in details about Radio Course, write for bulletin

PORT ARTHUR COLLEGE ■ PORT ARTHUR (World-known port) TEXAS

TRIED AND PROVEN by AMATEURS EVERYWHERE

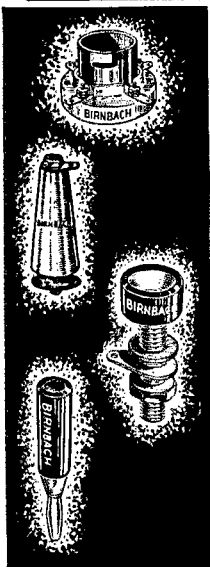

50 and 10 WATT SOCKETS
Designed especially for U.H.F. work.
No. 434 — 50 watt socket. **\$1.25**
List, each
No. 435 — 10 watt socket. **\$.85**
List, each

IMPROVED STANDOFF INSULATORS

In a complete range of heights for condensers, coils, etc. White glaze.

No.	Heights	List
430	3 1/2"	10c
431	3"	15c
431J	1"	20c
432	1 1/4"	20c
432J	1 1/4"	25c
433	2 3/4"	25c
433J	2 3/4"	50c

GIANT INSULATED PLUG

No. 392 with insulated handle. Fits into recess leaving no metal to contact hand. 3" overall. Red or black. List, each **50c**

GIANT INSULATED JACK

No. 393 leaves no exposed metal when mounted on panel. 1 1/4" long, red or black. Complete with nut, insulating washer for 1/8" mtg. hole. List, each **40c**

FREE CATALOGUE
Yours is waiting! Address Dept. 6-Q

BIRNBACH RADIO CO.
145 HUDSON ST. BIRCO NEW YORK, N. Y.

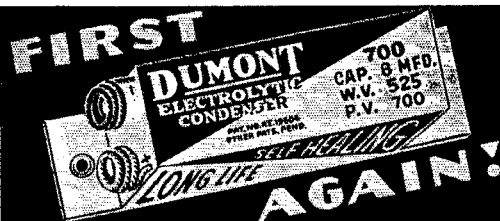

An Amazing Improvement in Electrolytic Condensers

NEW! NEW!
The only
Anti-Drift
Low-Loss
Mica Con-
densers with
silver plates.
Literature
on request

DUMONT engineers produced and patented the world's first electrolytic condenser in common use today. Same engineers, after five years' research now produce **FIRST SUPER HIGH VOLTAGE** Electrolytic. Reheats if overloaded or punctured. This patented feature is found only in **DUMONT** Condensers. Used by U. S. Government — a real test of quality. Used

in highest priced radio receivers, yet sold at very attractive price. Try some today and be convinced. **FULLY GUARANTEED FOR 1 YEAR.**

Manufactured by

DUMONT ELECTRIC CO., Inc.
514-516 Broadway, New York

Write for free catalogue, nearest jobber and attractive discounts

World's
Leading
Mfr. of
Precision
Condensers

examination paper, and for this reason even the skilled radio man can study it with profit before going up for a ticket.

A particularly useful feature of the book is that it will enable one to determine the type of license required for a specific kind of operation, and also serve as a gauge to the training required to secure any grade of license.

—C. B. D.

A New Frequency-Checking Device

(Continued from page 25)

of two adjacent 100-kc. signals in mind, count the number of carriers between them. The number between any two adjacent 100-kc. points (not counting the 100-kc. signals themselves) will be one less than the number of the harmonic at which the multivibrator is locked. For instance, if nine additional signals are heard, the multivibrator is locking on its tenth harmonic, and if the oscillator is on 100 kc. the signals will be spaced 10 kc. apart. If seven additional carriers are heard, the multivibrator is locked on its eighth harmonic, and the signals will be 100/8, or 12.5 kc. apart. Other harmonics work out in the same fashion. With R_{11} all in, the multivibrator should lock on its 8th harmonic, and with R_{11} all out, on its 12th harmonic. The carrier spacing therefore can be varied between 12.5 and 8.33 kc.; 10-kc. spacing is probably most useful, however, because of the simplicity of using that figure.

As R_{11} is varied, the intermediate signals will jump suddenly from one frequency to another as the control changes over to a new harmonic. There is no gradual transition. This jumping, plus stability equal to that of the 100-kc. points themselves, is evidence that the multivibrator is under control. In each step, the resistor may be varied over a fair range before the control order changes, and this range of variation is useful because it will be found that certain settings will tend to bring all intermediate signals to about the same strength while others will accentuate certain frequencies. In general, the most desirable adjustment is the one which maintains the intermediate signals at about the same level or shows gradually increasing strength as a 100-kc. point is reached. The 100-kc. signals usually will be considerably stronger and hence easily identified. In any event, the 100-kc. points always can be checked simply by closing Sw_1 ; they are the

TURNER STREAMLINED 30-BT

Crystal Mike Assures
Quality Reports at Low Cost



This handsome new mike gets consistent broadcast-quality reports and modernizes your equipment. Semi-directional design assures freedom from feedback and reduces background noise. High output level — 52DB gives strong signals with less amplification. Will not blast from close speaking, and there are no peaks. Shock-absorbing suspension of the crystal prevents breakage and hand-fing noises. Finished in black and chrome. Complete with 8 feet of cable. Order today.

\$14¹¹
Net

STANDARD RADIO PARTS CO.

135 E. Second St.
Dayton, Ohio

208 W. Main St.
Springfield, Ohio

Licensed under patents of the Brush Development Co.

- ✓ **Elementary Principles** — an unusually clear and concise explanation of fundamental principles in both theory and practice.
- ✓ **Circuit** — terms, basic formulas and simple calculations arranged to serve the practical experimenter.
- ✓ **Tubes** — how they operate, characteristics, various uses, base connections and the most common types of characteristics yet established.
- ✓ **Workshop Practices** — a wealth of constructional hints for build- ing receivers — design and operation of various types of receiver designs and full construction details of receivers from the simplest to the most complex.
- ✓ **Oscillators** — design and construction of all essential and self-started oscillators, band switching, constant frequency, neutral- ization, tuning, with complete operating and constructional data for all the popular types of transmitters.
- ✓ **Keying** — explanation of key clicks, various ways of keying for different tubes and conditions.
- ✓ **Amplitude Modulation** — principles of amplitude modulation, various types of modulation, scales for test tubes, complete constructional data for amplifiers and modulators, as well as tube data for these units.
- ✓ **Ultra-High Frequency Receiver** — the problems encountered, constructional dope for many receivers from the simplest super- regenerative through to the advanced super heterodynes.
- ✓ **Ultra-High Frequency Transmitters** — oscillator circuits, sug- gested tubes and complete instructions for operation at these fre- quencies.
- ✓ **Antennas** — the action of radio waves in space, types of antennas, angles of radiation, radiation patterns, methods of feeding and tuning — in fact, all the dope about antennas.
- ✓ **Power Supplies** — operation of variations and filter chokes together with circuit diagrams and constructional information for power supplies, small and big.
- ✓ **Portable Equipment** — Battery operated transmitters, independ- ent power systems and light weight relay systems. The problems of both receiving and transmitting are covered in this section.
- ✓ **Laboratory Equipment** — How to make measuring equipment, modification of test gear, equipment for general use, signal generators, etc. — all valuable for the exacting amateur.
- ✓ **Layouts** — Arrangements with wiring diagrams as well as where space is at a premium. Breaker operation, construction of antenna masts, remote control systems and underwriters' rules.
- ✓ **Station Operating** — Proper procedure when operating, Com- munications Department activities, regulations pertaining to amateur radio, — and an appendix full of valuable general information.

THE RADIO AMATEUR'S HANDBOOK



American Radio Relay League, Inc.,
West Hartford, Conn., U. S. A.

Here's my dollar (\$1 POSTPAID IN CONTINENTAL U. S. A.)
\$1.25 POSTPAID ELSEWHERE

Send my HANDBOOK to —

Name _____
Address _____

● THE ● SCOPE OF THE BOOKLET

"BUILDING AN AMATEUR RADIO TELEPHONE TRANSMITTER"

This booklet is addressed primarily to readers who have at least read our companion booklet, "How to Become a Radio Amateur," and have, perhaps, built a simple telegraph transmitter and receiver, have received their license, have acquired some skill and experience as a code operator, and who now feel the urge to explore the possibilities of radio telephony. These people should find this booklet the exact answer to their needs.

Absolutely the first requisite in either building or operating a 'phone transmitter is a solid understanding of what we are attempting to do when we accomplish voice transmission. Understanding the functions of the various parts, we shall avoid difficulties. The saddest thing in amateur radio is a 'phone amateur who does not understand the operation of his apparatus. The book begins, therefore, with a discussion of the principles involved and makes every effort to make this discussion perfectly clear so that the reader can easily make it a part of his own knowledge. It then goes on to the actual construction and operation of an inexpensive but efficient 'phone transmitter.

Priced at 25 cents per copy, postpaid

AMERICAN RADIO RELAY LEAGUE
West Hartford, Connecticut

only ones which do not disappear when the multivibrator is shut off.

After a period of idleness, it is a good idea to check the number of signals between 100-kc. points to make sure that the multivibrator is still locking on its tenth harmonic. With the constants given in Fig. 1, there has been no tendency to shift over a period of time, but an occasional check does no harm.

FREQUENCY CHECKING

The uses of a device such as this are obvious. The accuracy with which band edges can be checked (and each 10-kc. point is equally accurate) depends upon three factors: The absolute accuracy of the frequency of the station used as a standard, the precision with which the oscillator is set to the standard, and the inherent frequency stability of the oscillator. This last factor is eliminated if measurements are made while the oscillator is continuously checked against the standard, but in the absence of such continuous checking is likely to be the determining factor. The inherent stability probably will vary with the construction and tubes, but after a reasonable warm-up period—say 15 minutes—it should be dependable within about 5 kc. on 14 Mc., with corresponding deviations on the other bands. The deviation in kilocycles is of course directly proportional to the frequency measured, but is constant in percentage.

Continuous checking is readily possible, and always should be used when measurements of the highest possible accuracy are to be made. An auxiliary receiver is required, but this does not mean that equipment not usually available has to be built. The b.c.l. receiver can be used when a local broadcast station is the standard, and if the set covers the short waves it can also be used for picking up WWV. In most cases there will be enough stray output on either the broadcast band or WWV's frequency so that no special coupling means other than bringing a wire from the output circuit of the unit near the receiver's antenna lead will be needed. Should the signal be too weak, it is a simple matter to insert a circuit tuned to the appropriate frequency—a broad-tuning affair using a cheap mica trimmer is sufficient—in series with the plate lead of the 6L7 and couple it to the auxiliary receiver. This will not disturb the regular operation of the unit.

A word about standards. The most desirable one, of course, is WWV. It is probably not generally realized that this station is available for a considerable part of every day except Saturday and Sunday, transmitting continuously on 5000 kc. from 4 p.m. to 2 a.m. E.S.T.³ The signal is modulated at 440 cycles, which makes it very easy to identify, and no doubt can be heard over most of the country. Care must be used to set the oscillator to zero beat with the carrier and not one of the side-bands, a point which can be checked when the tone modulation is cut off for voice announcements.

³ This service is in addition to the regular standard-frequency transmissions at mid-day. Complete schedules will be found in each issue of QST.

Field Day and Every Day

These rugged portable units prove their worth as
PERMANENT—MOBILE and EMERGENCY EQUIPMENT

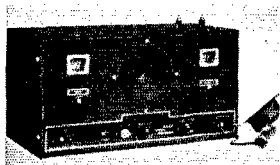

- TYPE TR-7**
- 56-60 Mc.
 - 10 w. carrier
 - 7 tubes
 - Phone-MCW

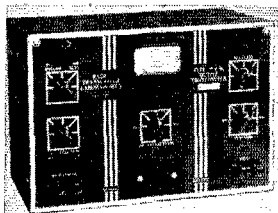

- TYPE HFM**
- Xtal Control all frequencies 1715-60,000 Kc.
 - CW-PHONE-MCW 12 to 21 w. carrier

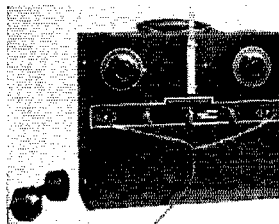

- "THE COMPACT"**
- 56-60 Mc.
 - 2 watt carrier
 - Batteries self contained

● WRITE FOR LATEST LITERATURE ●

Radio Transceiver Laboratories

8627 115TH STREET RICHMOND HILL, N. Y.

WORLD TIME at a Glance!



No guesswork with the **GORDON WORLD DX CLOCK**. Instantly tells GMT or local time of stations you contact. Available for 110 or 220 volts; 25, 40, 50 and 60 cycles. 24 hr., colored dials. Self-starting Watchman movement. Can be mounted flush in a panel. See your jobber today!

GORDON SPECIALTIES CO. 1104 S. Wabash Ave. CHICAGO, ILLINOIS

RADIO COURSES

RADIO OPERATING: Prepare for Gov't License Exam. ●
RADIO SERVICING: Including Short Wave ● **AMATEUR CODE** ● **ELECTRONICS** ● **TELEVISION** ●

Day and Evening classes—*Booklet upon request*

NEW YORK YMCA SCHOOLS
 4 West 63rd Street, New York City

110 VOLTS AC
 Anytime! Anywhere! With **KATOLIGHT PLANTS**

350 Watts AC and 6 Volts DC . . . \$ 89.60
 550 Watts AC and 12 Volts DC . . . 220.00
 1800 Watts AC and 18-32 Volts DC 228.00

Other sizes up to 10,000 watts, rotary converters and 2 KW to 8 KW Diesel-driven plants.
 200 watt AC generator for Ford V8 with driving attachments.
 Write for special discounts to amateurs
KATOLIGHT, Mankato, Minn., U.S.A.

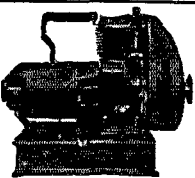

RADIO POSITIONS There are good positions waiting for good-type, well-trained men in radio . . . There are good opportunities for fine futures . . . but an advanced **COMPLETE ACTUAL PRACTICAL TRAINING** . . . as well as high type theory . . . is essential. Free Bulletin on Positions, Futures and Training.

Frank C. Jones Lecturer
 Author "Radio Handbook"

Arthur Halloran Lecturer
 Author "Cath. Ray & Tel."

PACIFIC RADIO SCHOOL
 Dept. A, 735 Larkin Street San Francisco, Calif.

Confidence in a Good Name

You get advanced engineering in Ken-Rad Tubes. For immediate good results specify Ken-Rad Tubes. All types of tubes available.



Ken-Rad Radio Tubes
KEN-RAD TUBE & LAMP CORPORATION - OWENSBORO, KY.
 Makers of all types of radio tubes and Ken-Rad Electric Lamp Bulbs

Say You Saw It in QST — It Identifies You and Helps QST

INVESTIGATE THE NATIONAL UNION MONOTRON!

A new tube for generation of a fixed television signal

Here's a new tube which holds great interest for the progressive amateur who wants to conduct his own experiments with generation of Television signals. The Monotron was developed by Marshall P. Wilder, W2KJL, Television Engineer of National Union. Demonstrations of the tube in use have caused intense interest on the part of amateurs who have seen it. Ask your jobber to show you a Monotron.

Ask him for complete data on this interesting tube!

National Union Radio Corporation
57 State Street, Newark, N. J.

AMATEUR RADIO'S GREATEST RECEIVER the skyrider diversity

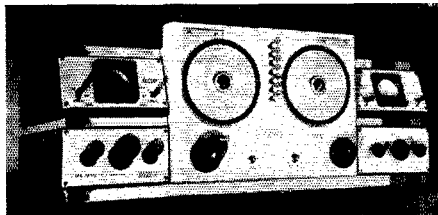

Diversity reception for the first time! This revolutionary new receiver practically eliminates fading, greatly improves signal strength, substantially betters signal to noise ratio and provides a quality of reception that is absolutely beyond comparison with any amateur receiver built today. Mail coupon today for complete description!

Now Available on Liberal H and E Terms
MAIL THIS COUPON

HINDS & EDGARTON

19 South Wells St., Chicago, U.S.A.

Please send me complete information on SKYRIDER DIVERSITY and H & E TIME PAYMENT PLAN.

Name.....Call.....

Address.....

The 10-ke. multivibrator makes it possible to use any broadcast station as a standard, so that it is not necessary to depend on those which happen to be on harmonics of 100 kc. It therefore becomes possible to pick one which maintains a high order of accuracy in its carrier frequency, or alternatively, to pick a local signal which is strong and not subject to fading. The frequency deviation of the b.c. station can be checked by simultaneous measurement against WWV, or usually can be obtained by getting in touch with one of the operators, since b.c. stations are required to have regular frequency checks made. In most cases the deviations are much less than the 50-cycle maximum allowed by the F.C.C.

In making measurements where accuracy is important and where the multivibrator is to be in use, the final adjustment of the oscillator should be made with the multivibrator on, since switching it on and off will cause a slight frequency change. This change amounts to one or two hundred cycles at 14 Mc. A still greater change will result from varying the output volume control, R_6 , throughout its range, so this control likewise should be left set. As a matter of fact, the control is not strictly necessary since the same effect can be obtained by detuning of the output circuit. Perhaps a better arrangement would be to make R_6 fixed instead of variable, shunting it with a switch which will simply give an "on" and "off" position. This would eliminate the signal when not wanted, but still permit the unit to stay warmed up for instant use, while the level could be set by tuning C_2 .

FINDING UNKNOWN FREQUENCIES

The technique described is sufficient if the operator is working in a region where the approximate frequency is known, as is the case with bands from 30 Mc. down. To extend measurements in between bands or to 56 Mc., however, where the guideposts are few or completely missing, an extension of the method can be used for the preliminary work. In this case the auxiliary oscillator coils are pressed into service, along with a general-coverage receiver.

Let us suppose that the 56-Mc. band is to be located. Those working there know in an approximate way where the band is, but the limits are somewhat nebulous. The first step is to locate 1000 kc. on the broadcast band, either by picking up a station on that channel or by finding the appropriate harmonic of the 100-ke. oscillator. Then plug in the 1000-ke. coil and adjust the frequency to 1000 kc. The multivibrator should be off. Next, pick up the harmonic on 14 Mc., which is easy to do, and tune the receiver lower in frequency, counting harmonics until the fourth from 14 Mc. is reached. The receiver then will be adjusted to 10,000 kc. At this point, plug in the 10,000-ke. coil and adjust C_1 to give the same frequency. The harmonics now will be spaced at 10,000-ke. intervals, which should eliminate any possibility of picking the wrong one as a 56-Mc. band limit.

At this point the 56-Mc. coil should be plugged in at L_2 and coupled to the 56-Mc. receiver. The

THE RADIO AMATEUR'S LIBRARY

Many requests are received for copies of this list so we again present it in *QST* in its complete form — to give a comprehensive picture of our publishing services to the amateur.

No.	Title	Price
1.	<i>QST</i>	\$2.50 per year*
2.	List of Stations	Pre-war Out of Print
3.	Map of Member Stations	Pre-war Out of Print
4.	Operating an Amateur Radio Station	Free to members; to others 10c
5.	The Story of The A.R.R.L.	Out of Print See No. 13
6.	The Radio Amateur's Handbook	\$1.00**
7.	The Log	35c each; 3 for \$1.00
8.	How to Become a Radio Amateur	25c
9.	The Radio Amateur's License Manual	25c
10.	Hints & Kinks for the Radio Amateur	50c
11.	Lightning Calculators:	
	a. Radio (Type A)	\$1.00
	b. Ohms Law (Type B)	\$1.00
	c. Wire Data (Type C)	50c
	d. Decibel (Type D)	50c
	e. Parallel Resistance — Series Capacity (Type E)	50c
	f. Resistance Calculator (Type F)	50c
12.	Amateur Radio Map of the World	\$1.25
13.	Two Hundred Meters and Down: The Story of Amateur Radio	\$1.00
14.	Building an Amateur Radiotelephone Transmitter	25c

* In the United States and Possessions and Canada. Other Countries \$3.00 per year.

** Postpaid in Continental U. S. A. — \$1.25, postpaid, elsewhere
(SPANISH EDITION HANDBOOK — \$1.50, Postpaid)

THE AMERICAN RADIO RELAY LEAGUE, INC.

West Hartford, Connecticut

QST

BACK COPIES

The back copies of *QST* contain the record of development of modern amateur technique. They are invaluable as technical references. Our supply of most issues is already exhausted, but many since 1925 are still available.

Please consult this list before ordering specific issues referred to in *QST* and *Handbook* texts.

1925 copies — (except Jan., Mar., May and July)	\$2.00
1926 copies — complete	2.50
1927 copies — (except Jan., July and Oct.)	2.25
1928 copies — (except Jan., Feb., Mar., Aug., Sept.)	1.50
1929 copies — complete	2.50
1930 copies — (except Jan., Feb., Apr. and July)	2.00
1931 copies — (except November)	2.50
1932 copies — (except Feb., July, Aug., Sept., Oct.)	1.75
1933 copies — (except Jan. and Feb.)	2.50
1934 copies — complete	2.50
1935 copies — complete	2.50
1936 copies — complete	2.50
1937 copies — complete	2.50
1938 copies — as issued, each 25c — complete year	2.50

Single Copies, 25c Each, and Yearly Sets at
Price Indicated, Postpaid

Foreign add 50c for Yearly Sets

latter is then adjusted to the oscillator harmonic, which on the assumption that the receiver is capable of actually tuning through the band, will be 60 Mc. The adjacent harmonics are 50 and 70 Mc., which should be far enough removed so that there is no doubt about the right one. Should there be any uncertainty, however, it can be overcome by using an essentially similar process but with a frequency higher than 10,000 kc., say 20,000 or 30,000. But assuming that the 60-Mc. point is identified, the final step is to change the oscillator again to 1000 kc., set it as accurately as possible (against WWV, for instance) and note the band limits. Points will be available at 56, 57, 58, 59 and 60 Mc. It is even possible to go farther and get 100- and 10-kc. points, using the 100-kc. oscillator and multi-vibrator, but at the present time this refinement does not seem necessary.

Unlike the ordinary heterodyne frequency meter, a unit of this type can be used for measurement practically anywhere in the spectrum. There is no question of band-spreading or crowding on the higher-frequency ranges, nor does the personal factor of precision in reading a dial enter into checking band edges. There are no calibration curves to draw from widely-scattered points. On the other hand, such a unit forms an ideal source of calibration points for a frequency meter of conventional design, with accuracy limited only by that of the standard-signal source and the ability of the operator to keep the oscillator adjusted to zero beat.

Parenthetically, it can also be used (and has been) for transmitter frequency control, with a suitable amateur-band high-C circuit substituted for L_1C_1 .

W9RSO Wins H.P.M. Award

(Continued from page 29)

just how good the simple t.r.f. job can be when properly handled.

The 59 oscillator continued to get out pretty well, but the high-power urge—as it must to all men—took hold. "High power," in this case, meant 35 watts. This was achieved by adding a 46 power amplifier. With this rig 25 countries were worked, practically all on 7 Mc. The first real DX contacts were K6JPD and OM2LD. Oscar had sat up many nights until 2 A.M. trying to hook a few K6's, and he nearly fainted when OM2LD answered a CQ early one morning during the 1935 DX contest.

Late in 1935 he again rebuilt the rig, this time using a pair of 10's in the final. These same tubes—receiving types, costing 81 cents apiece—are still in use and going strong with about 75 watts input. He used up to 145 watts at one time, but the power transformer was not made to take it and indicated its disapproval by burning out.

During the past three years W9RSO has averaged something over a thousand hours' operating time each year, and has had several thousand QSO's on all the amateur bands except five. A total of 75 countries has been worked, with WAC

Where to buy it

A directory of suppliers who carry in stock the products of these dependable manufacturers.



BUTLER, MISSOURI 211-215 N. Main Street
Henry Radio Shop

CHICAGO, ILL. 833 W. Jackson Blvd.
Allied Radio Corp.

CHICAGO, ILL. 901-911 W. Jackson Blvd.
Wholesale Radio Service Company, Inc.

COLUMBUS, OHIO 203 N. Fourth St.
Bell Radio Parts Co.

DETROIT, MICHIGAN 5027 Hamilton Ave.
Rissi Brothers, Inc.

DETROIT, MICH. 171 E. Jefferson Ave.
Radio Specialties Co.

DETROIT, MICHIGAN 11845 Woodward Ave.
Radio Specialties Co.

KANSAS CITY, MO. 1012 McGee Street
Burstein-Applebee Company

ST. LOUIS, MO. 927 Pine Street
Gordon Radio Company

BUTLER, MISSOURI 211-215 N. Main Street
Henry Radio Shop

CHICAGO, ILLINOIS 833 W. Jackson Blvd.
Allied Radio Corp.

CINCINNATI, OHIO North Bend Road, Mt. Airy
Jos. N. Davies

MINNEAPOLIS, MINNESOTA 1124-26 Harmon Place
Lew Bonn Company

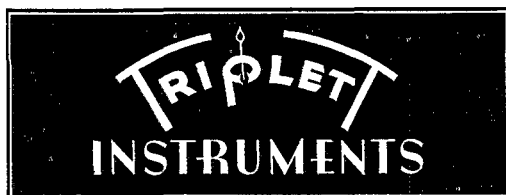

CHICAGO, ILL. 833 W. Jackson Blvd.
Allied Radio Corporation

CHICAGO, ILL. 901-911 W. Jackson Blvd.
Wholesale Radio Service Company, Inc.

CHICAGO, ILLINOIS 25 North Franklin Street
Electric & Radio Supply Co., Inc.

CLEVELAND, OHIO 610 Huron Road
Goldhamer, Inc.

MINNEAPOLIS, MINN. 1124-6 Harmon Pl.
Lew Bonn Co.

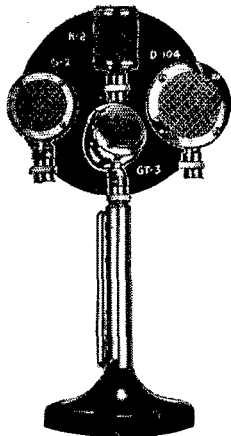

New! DESK STAND With Palm Control

Astatic's new Type G, Grip-To-Talk Desk Stand, designed with relay operating switch for remote control of amplifiers and transmitters, through suitable relay systems. Interchangeable socket connector to accommodate microphones illustrated.

Combination List Prices

GT-3— Mic. and Stand...	\$30.00
GK-2— Mic. and Stand...	32.50
GD-2— Mic. and Stand...	30.00
GD-104— Mic. and Stand...	27.50
Type G— Stand, alone.....	10.00

ASTATIC

Astatic Microphone
Laboratory, Inc.

830 Market St.
YOUNGSTOWN, OHIO

*Licensed Under Brush
Development Co. Patents*

? COMMERCIAL RADIO ?

If you are planning to prepare yourself for a job in commercial radio be sure and investigate the advantages offered by Eastern.

EASTERN RADIO INSTITUTE

899 BOYLSTON STREET

BOSTON, MASS.

HOW TO LEARN CODE

Whether you wish to enter radio as a career or merely add another valuable and fascinating accomplishment to your achievements, the All Electric Master Teleplex Code Teaching Machine will show you how.



Teleplex records your sending in visible dots and dashes on a specially prepared waxed paper tape and then sends back to you at any speed you desire. It does not merely show your code. It is code. No experience needed. Beginners, amateurs, experienced ops. get ahead faster this better way.

While not designated as standard equipment, Teleplex is used at many U. S. Army Posts, Naval Training Stations as well as the American Telephone & Telegraph Co. Also by practically every private school in the U. S. teaching the code; and many foreign governments.

We furnish you complete course, including practice messages, the All Electric Master Teleplex, plus a personal service on a **MONEY BACK GUARANTEE**. Low cost. Easy terms. *Without obligation write for booklet "Q6."*

TELEPLEX CO. 72-76 CORTLANDT ST.
NEW YORK, N. Y.

on c.w. and five continents on 'phone. The c.w. WAC is a two-bander—10 and 20—with four continents on 40. He is one of the earlier members of the W.A.S. Club, having certificate No. 87 dated March 12, 1936. For a time W9RSO was A.D.N.C.S. in the A.A.R.S., but the pressure of school and other activities proved too great to continue this. He has maintained a number of traffic schedules—notably with W4PL and WIFFP—despite irregular operating hours. He is fascinated most by ragchewing, and his log primarily shows contacts of this nature.

Other than amateur radio, his life was a full one. All this time he was attending Webb City high school, part of the time playing basketball on the school team. He also went out for track. During the last year of high he was president of the student government, treasurer of his class and also of the Aethlean literary society, and in charge of assembly programs. For one hour each day he worked in the office of the superintendent of the Webb City schools. At the close of his senior year he graduated as the highest ranking boy in the class.

All of which demonstrates fulfillment of tenet number 5 in the Amateur's Code—"the amateur is balanced." Yet despite these scholastic activities and the hundreds of hours of general amateur operation, W9RSO has been able to win letters from the Secretary of the Navy in two Navy Day competitions and to be second high for Missouri (a high state) in the 1937 S.S. (although it has no bearing on the award, he won in Missouri in 1938 and was sixteenth high nationally). In other contests, including particularly the VE/W get-togethers, he has done almost equally well.

As might be expected, he credits his family with a share in operating achievements. "My aunt is largely responsible," he writes. "I'll join with W6KFC in saying that the folks at home that put up with missed meals, etc., should really receive the glory."

Turning now from operating, his major experimental activity lies in the field of antennas. He has actually built and used on the air about 25 different types. These include Vee beams, W8JK beams, in- and out-of-phase types, reflector combinations, etc. He has tried both vertical and horizontal arrangements, as well as diversified feed systems. No one combination seems to fit all needs, but he is assured that the proper antenna for a given job is the most important part of the station equipment.

All of which serves, we hope, to illustrate the conclusion shown in the beginning. W9RSO is a successful amateur because, within the facilities at his command, he has done the ordinary deeds of amateur radio extraordinarily well. That characteristic in a young amateur is not a common one—especially these days, when we have fewer young amateurs—and it is that which raises Oscar Short above the average to the status of Maxim Memorial Award winner for 1937. To him, congratulations and best wishes. To the donors, his thanks and those of all amateurs for setting so inspiring an incentive to the coming generation of amateur radio.

HAM-ADS

(1) Advertising shall pertain to radio and shall be of nature of interest to radio amateurs or experimenters in their pursuit of the art.

(2) No display of any character will be accepted, nor can any special typographical arrangement, such as all or part capital letters be used which would tend to make one advertisement stand out from the others.

(3) The Ham-Ad rate is 15¢ per word, except as noted in paragraph (6) below.

(4) Remittance in full must accompany copy. No cash or contract discount or agency commission will be allowed.

(5) Closing date for Ham-Ads is the 25th of the second month preceding publication date.

(6) A special rate of 7¢ per word will apply to advertising which, in our judgment, is obviously non-commercial in nature and is placed and signed by a member of the American Radio Relay League. Thus, advertising of bona fide surplus equipment owned, used and for sale by an individual or apparatus offered for exchange or advertising inquiring for special equipment, if by a member of the American Radio Relay League takes the 7¢ rate. An attempt to deal in apparatus in quantity for profit, even if by an individual, is commercial and takes the 15¢ rate. Provisions of paragraphs (1), (2), (4) and (5) apply to all advertising in this column regardless of which rate may apply.

Having made no investigation of the advertisers in the classified columns, the publishers of *QST* are unable to vouch for their integrity or for the grade or character of the products advertised.

QUARTZ—direct importers from Brazil of best quality pure quartz suitable for making piezo-electric crystals. Diamond Drill Carbon Co., 719 World Bldg., New York City.

RADIO engineering, broadcasting, aviation and police radio, servicing, marine and Morse telegraphy taught thoroughly. All expenses low. Catalog free. Dodge's Institute, Byrd St., Valparaiso, Ind.

QSL'S, W2SN, Helmetta, N. J.

QSL'S, all colors, cartoons, snappy service. Write for free samples today. WIBEF, 16 Stockbridge Ave., Lowell, Mass.

USED receivers. Bargains. Cash only. No trades. Price list 3¢. W3DQ, Wilmington, Del.

CALLBOOKS—Summer edition now on sale containing complete up-to-date list of radio hams throughout entire world. Also world prefix map, press schedules and new time conversion chart. Single copies \$1.25. Canada and foreign \$1.35. Radio Amateur Call Book, 610 S. Dearborn, Chicago.

RCA ACT-20 transmitter like new \$95. with tubes. New ACR-155—\$44.50. Van Sickle Radio, W9KJF, Indianapolis, Ind.

QSL'S. Free samples. Theodore Porcher, 7708 Navajo St., Philadelphia, Pa.

CRYSTALS: special for June. 160M—80M AT and V cuts, four cycle coefficient, within five kilocycles, \$1.95. Holders, \$1. Catalog. Ham Crystals, 1104 Lincoln Place, Brooklyn, New York.

QSL'S, SWL's, 65¢ hundred, two color. Samples. W1PTM, 268 Piedmont, Waterbury, Conn.

CRYSTALS, mounted, 80-160 \$1.25, V-cut 40 \$2.25. R9 Crystals, 338 Murray Ave., Arnold, Pa.

WANTED: used transmitter 200 watts; also RME-69. Details first letter. VO4A.

USED transmitting tubes in stock: 852s, 242s; prices right. W3FBL, Larry Arnold, Richmond, Va.

BUY your next receiver from Larry W3FBL. Receivers sold on time. Liberal allowance for your old set.

LET us build your transmitter for you. Our shop is equipped to give you a factory job at much less than you expect to pay. Larry Arnold, W3FBL.

PROGRESSIVE III transmitters in stock sold in kit form or ready built. Write for quotations. W3FBL.

BRUNO VR-EP microphone, stand, 25 foot cord, never used, \$15.—RK20, \$5.—RK23, \$2.—\$41, \$1.—Cardwell XG25KC new, \$1. W1HJI.

QSL'S. Free samples. Printer, Corwith, Iowa.

BAKELITE panels, strips, tubing and rod. Write Hackbush, 29 Linwood, Tonawanda, N. Y.

CEKOMET bronze pulleys. Wall or rope type, \$1.80. Neutralizing condensers, one to nine mmf., \$1.50. Dealers write for discounts. W8CKO, 703 Broadway, E. McKeesport, Pa.

FOR sale: DeForest radio, sound, television course. Bargain. Inquire Carl Fastje, Denison, Iowa.

MUST sell Ultra Skyriver, \$60.; with matching speaker, \$65. f.o.b. Holt, W4TP, Warrenton, N. C.

WANTED: used Superhet receiver. W2FJH.

MAKE offer: SW3 20-40-80 coils. W7DDY.

DOUGLAS Universal Class B transformers—match all tubes—designed by W8UD—50 watts \$4.95 pair, 100 watts \$7.75 pair. Postpaid in U. S. Guaranteed. For details write W9LXR, Rice Lake, Wis.

MONTH old Sky Challenger II, speaker, crystal, \$75. Must sell. Marion Graham, Angola, Ind.

QSL cards, neat, attractive, reasonably priced. Samples free. Miller, Printer, Ambler, Pa.

HALICRAFTER Model SX16 and speaker priced for quick sale. Gertrude B. Logan, Decatur, Ill.

TRY us first for radio supplies—Loughnane & Co., Decatur, Ill. SACRIFICE complete station. Write W2JRV.

BLILEY crystals. W8DED.

QSL'S, W8DED QSL's unbeatable. Samples? (stamp) W8DED, Holland, Mich.

SELL: SW3, 20-40-80-160 coils, tubes, power supply, \$15. Lafayette transceiver and tubes, \$5. 5 meter a.c. receiver 56, 42, 80 tubes, speaker, \$10. Shure 5B mike and stand, \$5. W2FKB, 9345 Vanderveer St., Queens Village, N. Y.

NATIONAL NC100 like new, \$75. McMurdo Silver 5B crystal filter, \$35. Hammarlund Pro, \$35. W9IPS.

TRADE: 200 watt transmitter, FB job; 2 MG's. Want screw-cutting bench lathe, lab equipment, cash. Foto? W8BQ.

WEAR your own call letters in a gold filled tie or lapel pin. Satisfaction or full refund. Send 75¢ to Wireart, Ocean Park, Calif. No C.O.D.'s.

QSL'S, 75¢ a 100, two colors; postpaid. W9DGH, 2005 N. 3rd Ave., Minneapolis, Minn.

SELL: SW3, 6 coils, complete—\$15. Wanted: printing press. W2IUW.

SELL: 160, 80, 10 UHX10 coils, new; best offer. W3FHY.

QSL'S. Finest quality. Lowest prices. Free samples. Maleco, 1512 Eastern Parkway, Brooklyn, N. Y.

FOR sale: 250 watt Collins 30 FXC 20 and 160 meter coils. Best offer. D. Hall, Springfield, L. I., N. Y.

SEXTANT: fine condition, swap for superhet. W2DNW.

1000 watt transformers (G.E.) on marble bases 1100-2900-4400 each side center. Hundreds sold hams last eleven years—guaranteed unconditionally. Dawson, 5740 Woodrow, Detroit, Mich.

QSL'S, SWL's, 100, 3 color, 75¢. Lapco, 344 W. 39th, Indianapolis, Ind.

USED equipment. W9ANZ.

HALICRAFTER—Taylor—Bliley—Thordarson—W9ANZ.

NEBRASKA hams' headquarters in Leuck Electric Service. W9ANZ.

\$180, cash. Lafayette forty watt phone transmitter, grey; D-104 crystal mike; all tubes, spare 913, RK-37; coils, crystals for ten, twenty, eighty phone; antenna relay. W9YMZ.

1000's Y-cut crystals, 75¢. Networks spot frequencies, \$1. Free catalog. Faberadio, Batavia, Ill.

CRYSTALS: X cut, 80-160 = five kilocycles, \$1.50; spot frequency, \$2.50. Special prices to Army, Navy, Red Cross and other round table nets. Three small, 80 meter blanks, including carborundum, \$1.20. Holders, \$1. William Threm, W8FN, 3071 Moosewood St., Cincinnati, Ohio.

KITS assembled. Transmitters or any type of special equipment built to order. Radio Supply, 2114 Main, Joplin, Mo.

CRYSTALS: zero cut. New low drift. 160-80-40 meters, \$1.85; 20 meter crystals, \$3. postpaid. Plug-in mountings 75¢. Fisher Lab., 4522 Norwood St., San Diego, Calif.

SELL several used RK20s, \$4. Guaranteed O.K. Taylor Rice, W4VK, Ripley, Tenn.

OSCILLOSCOPES—trapezoidal pattern type, complete less 913 and 80 tubes. Money-back guarantee—\$7.95. Send \$3., balance C.O.D. Harding & Townsend, Sutherland, Neb.

NEGATIVE peak overmodulation indicator. Eye closes with overmodulation. Kit includes RCA-6E5, RCA-80, mounting assembly, acetucone, condensers, resistors, sockets, diagram, instructions. Postpaid, \$3. California orders not accepted. Wm. D. Hayes, 429 Perkins St., Oakland, Calif.

CRYSTALS: performance, not elaborate advertising, put 79 crystals over. High activity type, fracture resisting X cut; 40 and 80 meter bands \$1.60, 7301-7500 c.e. range \$2. FB 79 ceramic holders \$1.10. Prices postpaid, C.O.D.'s accepted. Fully guaranteed. Satisfaction and prompt service our motto. Various types of fine commercial crystals supplied on order, inquire. Sold by: EIDSON'S, Temple, Texas; Van Radio, 464 E. 117th No. 7, Cleveland, Ohio; Pembleton Labs., Ft. Wayne, Ind.; Henry Radio Shop, Butler, Mo., The Hargs Co., Austin, Texas; Hieronymus Radio, 88-34 209th St., Queens Village, N. Y.; Southwest Radio Supply, Dallas, Texas; Radio Atlas, Tampico, Mexico.

SELL, trade: complete fone station. W9MLB.

EIGHTEEN foot lengths one inch hard drawn copper tubes, \$3. each, two for \$5. FB for antennas, five meters. W9ERU.

TRANSMITTERS constructed—complete or sections; your parts or new. Coils wound to order. Howard Radio, 231 Menard, Chicago.

RTL TR6A6 transceiver; pack; tubes, \$39.50. W6DWA.

SACRIFICE for quick sale Collins 30 FX complete—perfect condition, \$75. Hoke Franciscus, Carlisle, Penn.

QSL'S, SWL's. Prices you'll never see again. Fritz, 455 Mason, Joliet, Ill.

TELEPLEXES, instructographs, omnigraphs, vibroplexes bought, sold. Ryan's, Monroe City, Mo.

COAXIAL line systems. New types. Assembled. Kits. Low cost. Other specials. Circular. Eastern Technical Service, Oriskany, N. Y.

WANTED; used Junior Candler course. Richard Kirby, Thermopolis, Wyo.

CONCENTRATED beam power, tilting head, worm drive rotaries, dural tubing, those \$1,000,000 relay racks, panels. W8MLL.

TRY a reconditioned receiver for ten days without obligation: HROs \$129.70, RME-69s \$99., NC100s \$89., RME9Ds \$59., Breting 12s \$59., PR-16Cs \$59., S11s \$59., Sky-Challengers \$49., S9 Super-Skyriders \$39., Silver 5Cs \$29., Sky-Chiefs \$29., S34 Super-Skyriders \$24., Sky-Buddies \$19., FB7s \$19., SW3s \$12.50, many others. List free. W9ARA, Butler, Mo.

QSL'S—highest quality—lowest prices. Radio Headquarters, Ft. Wayne, Ind.

SELLING station: one hundred watt c.w. transmitter, 8 tube 8s superhet, twenty watt modulator, parts. Stanley Hunt, 315 Cherry St., Douglaston, L. I.

CASH for ham receiver, W8RUI, McKeesport, Pa.

HEAVY autobody welded steel chassis. Any size, shape. W8MLL.

NEW and used receivers. W8ANT.

TRANSMITTER headquarters. W8ANT.

ALL lines of new and used amateur equipment bought, sold, exchanged. Write to Southern Ohio's only amateur owned amateur business. Jos. N. Davies, 2767 N. Bend Rd., Sta. A., Cincinnati, Ohio.

CHICAGO hams. Complete station for \$75. Rig breadbord style with bench. Good parts, 53—TZ20—203A. Coils for 20 and 40. Rcvr is FB7A with coils for 20, 40 and 80. Home built power pack. Call Well. 8525. W9MMX.

G.E. 861 nearly new, \$45; 841, 845, 211s, sockets; W.E. condenser head, \$12.; handset; G.E., Weston meters, \$3., RF, \$6.; G.E. 12a. Tungar; regulated B; best AmerTran, Inca audio components, bargain. Want auto radio. Pat Shultz, 4849 Carpenter, N. Hollywood, Calif.

MAKE your own air-wound coils. One to four inch wood forms, 50¢; three for \$1. W9UET.

HALLIGRAFTERS Ultra Skyrider SX10, \$65; PR-16, \$60; phone rig running 225 watts to HF 100 modulated with 2 809 in Class B. Speech is 56 into 67 into a pair 45 in push pull. Exciter is 6L6 (40) 6L6 (20) parallel 6L6 on 10.7 meters. All in good working condition. Separate power supplies for each unit; complete with crystal tubes and coils, \$135. Reference: Second National Bank, Alban Michel, Reading, Ohio.



NEW HOLDER DESIGN

15 SECONDS TO
INSTALL CRYSTAL

For All Bands
GREATER STABILITY
Plugs in 5 prong tube socket
Beautiful Appearance

MODEL AH HOLDER \$1.00 At your dealer or direct

HIPOWER LOW DRIFT CRYSTALS:
within 10 kc. or Choice of stock

AH-10, 1700-3500 Kc. bands \$2.35
AH-10, 7000-7300 " bands 3.90

WRITE FOR NEW LITERATURE

HiPower "Low Drift" Broadcast and Commercial
Crystals Are Approved by F.C.C.

HiPower Crystal Co., 2035 Charleston St., Chicago

PORTRAIT OF AN AMATEUR WHO NEEDS CANDLER TRAINING!



It's no disgrace to be licked by some "dit dah" speed artist. Real code speed is practically impossible to get alone, regardless of the hours upon hours spent in practice. It requires special training in fundamentals, proper mental co-ordination and expertly directed practice, — all of which you get with Candler Training. You'll be amazed at the progress you can make in only a short time. Thousands upon thousands of amateurs and professional ops owe their smooth, rhythmic speed to Candler Training. Code Champions, like I. R. McElroy and L. R. McDonald, W8CW, attribute their amazing speed to the mental training that Candler gives. It's the real short cut to Code Speed — and it is not expensive.

SEND FOR FREE BOOK OF FACTS

A 52-page book packed with vital information for beginners and advanced operators. It's FREE, send for your copy today!



CANDLER SYSTEM CO.

Dept. Q6

Asheville, No. Carolina, U.S.A.

RADIO

ENGINEERING, broadcasting, aviation and radio telegraphy and telephony, Morse telegraphy and railway accounting taught thoroughly. Engineering course of nine months' duration, equivalent to three years of college radio work. School established 1874. All expenses low. Catalog free. DODGE'S INSTITUTE, Day Street, Valparaiso, Indiana

PAR-METAL

offers you the most complete line of
RACK AND PANEL EQUIPMENT

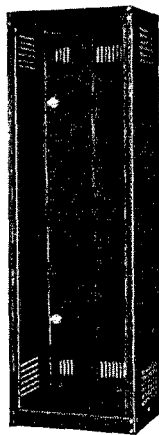

PAR-METAL offers you a uniform line of standardized metal products that enables you to quickly build up a job that is professional both in construction and appearance.

Our new catalog 38 lists everything you need. In it you will find relay racks, cabinets, panels, chassis and other useful accessories in various sizes to meet almost every requirement.

Write for your free copy or ask your nearest jobber.

**PAR-METAL PRODUCTS
CORP.**

3529 41st St., Long Island City, N. Y.

Your Nearest Dealer Is Your Best Friend

Your nearest dealer is entitled to your patronage. You can trust him. He is equipped with a knowledge and understanding of amateur radio. He is your logical and safe source of advice and counsel on what equipment you should buy. His stock is complete. He can supply your needs without delay. His prices are fair and consistent with the high quality of the goods he carries. He is responsible to you and interested in you.

Patronize the dealer nearest you—You can have confidence in him

<p>CHICAGO, ILLINOIS</p> <p>Allied Radio Corporation 833 West Jackson Blvd.</p> <p>Complete standard lines always in stock—W9IBC, W9DDM, W9GEZ</p>	<p>KANSAS CITY, MISSOURI</p> <p>Burstein-Applebee Company 1012-14 McGee Street "Specialists" in supplies for the Amateur and Serviceman</p>
<p>CHICAGO, ILLINOIS</p> <p>Chicago Radio Apparatus Company 415 South Dearborn Street (Est. 1921)</p> <p>W9RA and W9PST — Amateurs since 1909</p>	<p>KANSAS CITY, MISSOURI</p> <p>Radiolab 1515 Grand Avenue Amateur Headquarters in Kansas City</p>
<p>CHICAGO, ILLINOIS</p> <p>Wholesale Radio Service Company, Inc. 901-11 West Jackson Boulevard</p> <p>"The World's Largest Radio Supply House"</p>	<p>MILWAUKEE, WISCONSIN</p> <p>Radio Parts Company, Inc. 538 West State Street Complete stock Nationally Known products</p>
<p>DES MOINES, IOWA</p> <p>Iowa Radio Corp. 1212 Grand Avenue Complete amateur stock, W9OCG—W9EMS—W9KAY</p>	<p>MINNEAPOLIS, MINNESOTA</p> <p>Lew Bonn Co. 1124-26 Harmon Place W9BP—W9TLE—W9HOP—W9DKL—W9LEX</p>
<p>DETROIT, MICHIGAN</p> <p>Radio Specialties Company 171 E. Jefferson Avenue Ham Supplies — National & Hammarlund Sets and Parts</p> <p>DETROIT, MICHIGAN</p> <p>Rissi Brothers 5027-31 Hamilton Ave. at Warren WBKXK Manager Amateur Department</p> <p>FRESNO, CALIFORNIA</p> <p>Ports Manufacturing Co. 3265 E. Belmont Ave. Wholesale: RCA-Thorderson-Biley. All Standard Lines</p>	<p>OAKLAND, CALIFORNIA</p> <p>Offenbach Electric Company 2085 Broadway "The House of a Million Radio Parts"</p>
	<p>SAN FRANCISCO, CALIFORNIA</p> <p>Offenbach Electric Company, Ltd. 1452 Market Street "The House of a Million Radio Parts"</p>
	<p>SEATTLE, WASHINGTON</p> <p>Northern Radio Company 2208 Fourth Avenue W7AVC, W7FRF, W7AWP to serve you</p>
	<p>ST. LOUIS, MISSOURI</p> <p>Van Sickle Radio Company 1113 Pine Street W90WD invites you to amateur headquarters in St. Louis</p>
	<p>TORONTO, CANADA</p> <p>A & A Radio Service Supply 101 Queen Street, West Canada's foremost radio supply house</p>
	<p>TORONTO, ONTARIO, CANADA</p> <p>Wholesale Radio Company, Ltd. 1133-37 Bay Street Canada's Largest Radio Parts Distributors — VE-3XB</p>
	<p>WINNIPEG, CANADA</p> <p>Electrical Supplies, Ltd. 306-10 Ross Avenue Western Canadian Amateur Headquarters for leading lines</p>

You Are Protected When You Buy From QST Advertisers

“Advertising for QST is accepted only from firms who, in the publisher’s opinion, are of established integrity and whose products secure the approval of the technical staff of the American Radio Relay League.”

Quoted from QST’s advertising rate card.

Every conceivable need of a radio amateur can be supplied by the advertisers in QST. And you will know the product has the approval of the League’s technical staff.

The Advertisers

Acme Electric & Mfg. Company	86
Astatic Microphone Laboratory, Inc.	106
Birnbach Radio Company, Inc.	98
Biley Electric Company	97
Candler System Company	108
Capitol Radio Engineering Institute	90
Cardwell Mfg. Corp., Allen D.	76
Centralab	67
Collins Radio Company	Cov. 2
Cornell-Dubilier Corp.	90
Dodge’s Institute	108
Dumont Electric Company	98
Eastern Radio Institute	106
Eitel-McCullough, Inc.	69
Gardiner Levering Company	93
Gordon Specialties Company	101
Hallcrafters, Inc., The	1, 2, 58, 59, 60, 61, 62, 63
Hammarlund Mfg. Company, Inc.	68, 73
Harvey Radio Company	100
Harvey Radio Laboratories, Inc.	95
Heintz & Kaufman, Ltd.	95
Henry Radio Shop	86
Hinds & Edgerton	102
Hipower Crystal Company	108
Hygrade Sylvania Corp.	86
Hytronic Laboratories	83
Instructograph Company	97
International Resistance Company	71
Jensen Radio Mfg. Company	65
Kato Engineering Company	101
Ken-Rad Tube & Lamp Corp.	101
Kenyon Transformer Company, Inc.	5
Logan Company, Les.	90
Mallory & Company, Inc., P. R.	56
Massachusetts Radio School	82
McGraw-Hill Book Company	74
Meissner Manufacturing Company	87
Mims Radio Company	92
National Company, Inc.	Cov. 3, 55, 81, 93
National Radio Parts Trade Show	57
National Union Radio Corp.	102
New York Y. M. C. A. Schools	101
Newark Electric Company	91
Ohmite Manufacturing Company	70
Pacific Radio School	101
Par-Metal Products Company	108
Port Arthur College	97
Precision Apparatus Corp.	90
Precision Piezo Service	78
RCA Institutes, Inc.	93
RCA Manufacturing Company, Inc.	Cov. 4, 72
Radio, Ltd.	93
Radio Mfg. Engineers, Inc.	79
Radio Shack, The.	104
Radio Supply Company	92
Radio Transceiver Laboratories	101
Scientific Radio Service	93
Shure Brothers	94
Sickles Company, F. W.	97
Solar Mfg. Corp.	86
Speer Carbon Company	64
Standard Radio Parts Company	98
Sun Radio Company	96
Taylor Tubes, Inc.	75
Teleplex Company	106
Terminal Radio Corp.	92
Thorndarson Electric Mfg. Company	77
Triplet Elec. Instr. Co., Inc.	94
United Electronics Company	80
United Transformer Corp.	111, 112
Utah Radio Products Corp.	82
Valpey Crystals, The.	92
Vaxley	56

New POPULAR PRICED TRANSMITTER KITS

This new series of kits represents the acme in kit value. The circuits are efficient, stable and easy to wire. Large etched plates and modern panel layouts lend beauty to the slate gray crinkle finish of the chassis, transformers, and cabinets.

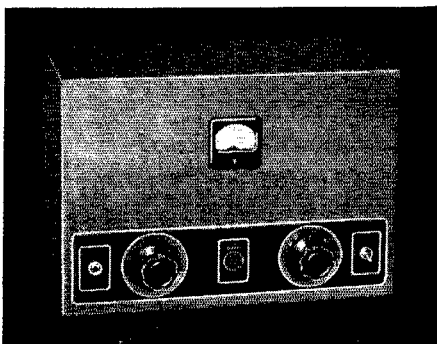

SX-25

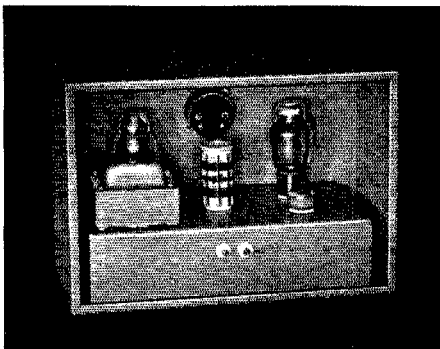

The UTC SX-25 kit represents unprecedented value in a low power transmitter. It employs a crystal controlled oscillator of high power output and stability and will operate on all bands from 160 to 10 meters. Tubes required are one 6L6G and one 83. The unit is supplied completely mounted with self-contained power supply and antenna tuning condenser, ready to wire, including cabinet and *all* accessories, less meter, tubes and crystal. **Amateur Net Price** **\$18.00**

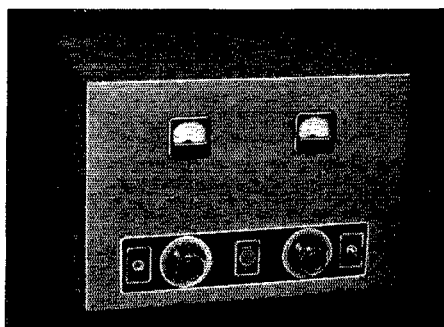

SX-80

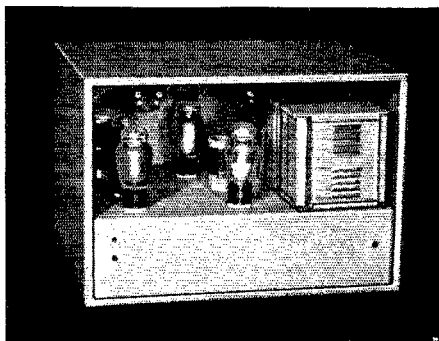

The UTC SX-80 kit is a complete 80 watt CW unit. Operation on all bands is obtainable with plug-in coils. A rugged power supply is provided. The kit may be used as a complete 80 watt CW unit or as an exciter for a high power final. Tubes required are three 6L6's and one 83. This unit is supplied completely mounted, ready to wire, including cabinet and accessories, less meters, crystal and tubes. **Amateur Net Price** **\$37.50**

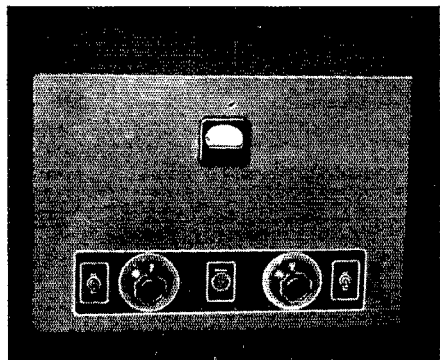

SX-200

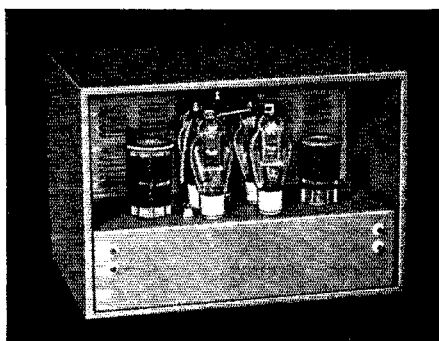

The UTC SX-200 transmitter kit is used in conjunction with the SX-80 or any similar exciter having a power output of 40 watts or more, to form a complete 300 watt CW transmitter. When supplemented by the S-100 modulator it becomes a 200 watt phone transmitter. It will operate on all frequencies up to 30 megacycles and incorporates a highly efficient power supply. Tubes required are two 866A's and four 809's. This unit is supplied completely mounted, ready to wire, including cabinet and accessories, less meter, crystal and tubes. **Amateur Net Price** **\$43.50**

UNITED TRANSFORMER CORP.

72 SPRING STREET

NEW YORK, N. Y.

EXPORT DIVISION 100 VAPICK STREET NEW YORK, N. Y. CABLES "ARLAB"

Say You Saw It in QST — It Identifies You and Helps QST

New POPULAR PRICED AMPLIFIER KITS

S-15A AUDIO AMPLIFIER

The S-15A audio amplifier is an ideal kit for PA and modulator service. The power output is 15 watts and the gain sufficient for crystal mike service. Dual input — high or low gain, and tone control are incorporated. Tubes required are one 6J7, one 6C5, two 6V6's and one 83. The kit is supplied completely mounted, ready to wire, including accessories, less dust cover and **\$24.00**
Amateur Net Price

Kit as above but with universal modulation transformer in place of voice coil output, use kit No. S-15M. **\$24.00**
Amateur Net Price

Dust cover for above amplifiers, type S-15D. **\$1.50**
Amateur Net Price

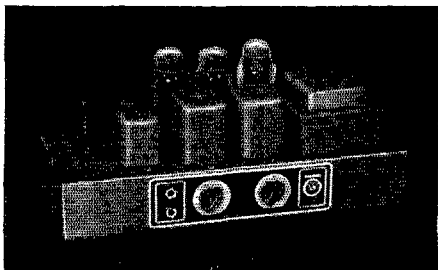

S-25A AUDIO AMPLIFIER

The S-25A audio amplifier has been designed for high power PA and medium power modulator work, 25 watt output is provided with gain sufficient for crystal mike. Dual high impedance input — high or low gain, and tone control are provided. Tubes required are one 6J7, one 6C5, two 6L6's and one 83. The kit is supplied completely mounted and ready to wire, including all accessories and dust cover, less tubes. **Amateur Net Price \$30.00**

Kit as above but with universal modulation transformer in place of voice coil output, use kit No. S-25M. **\$30.00**
Amateur Net Price

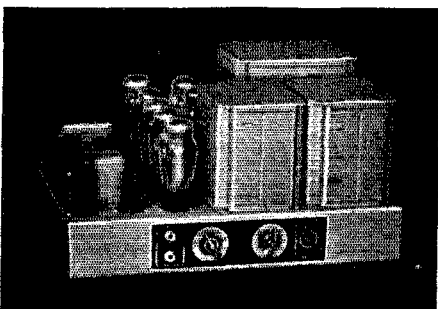

S-100 AUDIO AMPLIFIER

The S-100 audio amplifier is an ideal low priced high power unit. 100 watt output is provided with gain sufficient for crystal mike. Dual input and tone control is provided and universal modulation output transformer. Tubes required are one 6J7, one 6C5, two 6F6's, four 6L6's and three 83's. The kit is supplied completely mounted, ready to wire, including all accessories, less **\$52.50**
Amateur Net Price

Kit as above with PA output transformer for universal voice coil impedance, use kit No. S-100PA. **\$55.00**
Amateur Net Price

Cabinet for above to match SX-80 and SX-200. No. S-100C. **Amateur Net Price \$3.75**

New SERIES of TRANSFORMERS designed specifically for AMATEUR and PA EQUIPMENT Maximum Value at Low Cost

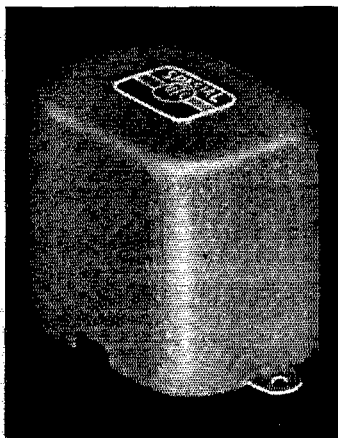

UNIVERSAL DRIVER TRANSFORMERS

(See Modulator chart for tube types)

Type No.	Application	Net Price
S-8	Single driver plate to pushpull grids	\$1.65
S-9	Pushpull driver plates to grids of class B tubes up to 400 watts output.	2.25
S-10	Pushpull 56, 6C6 triode, 6C5, or similar plates to 45's, 2A3's or 6L6's, self or fixed bias.	2.10

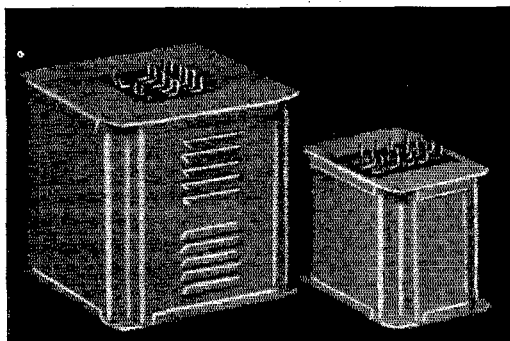

UNIVERSAL OUTPUT TRANSFORMERS

Any modulator tubes to any RF load. (See chart)

Type No.	Audio Power	Net Price
S-18	12 watts	\$2.10
S-19	30 watts	2.85
S-20	55 watts	3.90
S-21	110 watts	6.00
S-22	250 watts	8.40

UNITED TRANSFORMER CORP.

72 SPRING STREET

NEW YORK, N. Y.

EXPORT DIVISION 100 VARICK STREET NEW YORK, N. Y. CABLES "ARLAB"

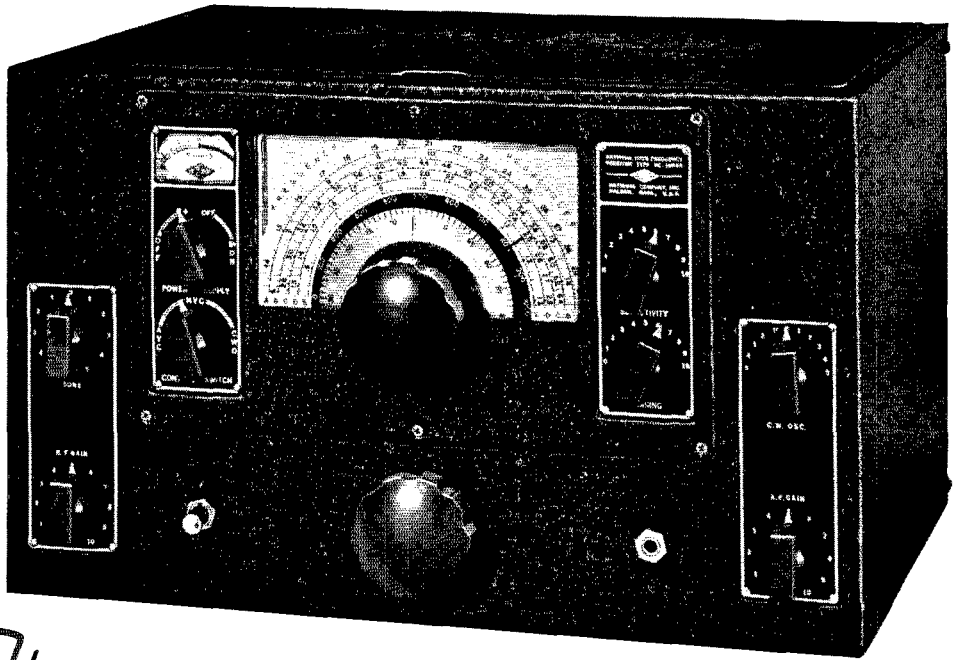

*The NC-100X
in new dress*

NC 100-XA

In accordance with National's policy of constant improvement, the mechanical details of the NC-100X have been redesigned to give new ease of control. Particularly notable is the new dial with direct reading scales for each band, calibrated in Megacycles. The pointer is ganged to the band-change mechanism and moves radially to point directly to the proper scale. An additional high-speed dial reads to one part in a thousand, for accuracy in logging. Other changes include the use of a meter for signal strength measurement instead of a "magic eye" and complete restyling of the cabinet. Although the time-proven chassis remains unchanged, the cabinet has been made slightly larger to accommodate the dial. The new models will be designated the NC-100XA and the NC-100A. Older models can be factory-rebuilt to include the new features at a net cost of \$25.00, by arrangement through your dealer.



NATIONAL COMPANY, INC.
MALDEN, MASS., U. S. A.

NEW RCA 2-INCH CATHODE RAY TUBE

Features
Unusually High
Sensitivity

This latest RCA 2-inch Cathode Ray Tube is the result of RCA's wide experience in the designing of these types. It provides unusually high sensitivity and excellent focus. Moreover, the 902 is electrically interchangeable with the RCA 913, provided the anode No. 2 supply voltage is 400 volts or more. And all this new tube costs is \$7.50. Further details available on request.

RCA 902's Characteristics

Heater Voltage (A. C. or D. C.)	6.3 Volts
Heater Current	0.6 Ampere
Spot Color	Green
Screen Persistence	Medium
Overall Length	$7\frac{7}{16}'' \pm 3/16''$
Maximum Diameter	$2\frac{1}{16}''$
Base	Medium Shell Octal 8-Pin
High-Voltage Electrode (Anode No. 2)	Voltage, 600 volts, max.

Typical Operation

Anode No. 2 Voltage	400	600	Volts
Anode No. 1 Voltage	100	150	Volts (Approx.)
Deflection Sensitivity:			
Plates D-1 and D-2	0.28	0.19	Mm/Volt D.C.
Plates D-3 and D-4	0.33	0.22	Mm/Volt D.C.

RCA presents the Magic Key every Sunday, 2 to 3 P. M.,
E. D. T. on the NBC Blue Network.

\$7.50



Radio Tubes

FIRST IN METAL
FOREMOST IN GLASS
FINEST IN PERFORMANCE

1938 Board Meets

THE Board of Directors of the American Radio Relay League held its annual meeting in Hartford May 13th and 14th. It voted to reëlect President Woodruff and Vice-President Bailey for an additional 2-year term, to authorize a national convention in Chicago this fall, to request the F.C.C. to open the frequencies above 112 Mc. to television after deleting it from 1.7 and 56 Mc., to appropriate funds for the completion of WIAW, to defray expenses of S.C.M.'s to conventions, to hereafter publish minutes of the Executive Committee in *QST*, and to perform a number of other routine actions. In addition it referred the matters of 'phone in 2000-2050 and the extension of low-frequency stability requirements to all bands below 60 Mc. to newly-created mechanism for polling amateur sentiment, heard supplementary oral Cairo reports by Secretary Warner and General Counsel Segal, received reports from the Membership Committee and the Planning Committee (and authorized continuance of the latter), created a committee to consider adoption of some form of retirement pension plan for A.R.R.L. employees, and decided to hold its next meeting (May, 1939) in San Francisco, at the time of the World's Fair.

For fifteen hours the Board considered matters brought before it by the individual directors, responsive to the wishes of the membership in their divisions. Every division was represented, there being in attendance at the meeting its able chairman, Dr. Woodruff, the fourteen divisional directors, the Vice-President, Canadian General Manager, the other officers, the General Counsel, assistant secretaries, and the Assistant Technical Editor as expert advisor. Also in attendance, as non-participating observer, was the alternate director of the Atlantic Division, Mr. R. E. Macomber of Washington, D. C.

The Board received reports from its officers and committees, examined the work of the Executive Committee and its own informal actions of the past year, and then heard detailed reports from every director on conditions in the respective divisions. From these reports arose a foundation of information on conditions and trends which served as the basis for subsequent examination of the problems found to exist.

General interest attached to the report of the Planning Committee. This committee, authorized at the previous year's meeting, was composed of some 70 amateurs outstanding in various fields selected on a divisional basis; a comprehensive analysis of their views on nearly 60 questions was presented by Mr. Handy. These views affected consideration of such questions as frequency assignments, licensing procedure, etc. The value of the committee was felt to be such that it was voted to extend its functions an additional year.

Following a general inspection by the individual directors of the Maxim Memorial Station building at Newington, the Board expressed its approval by appropriating the sum of \$11,000 to complete the cost of the structure and equipment, this amount being in addition to the \$7,000 appropriated in 1936. Communications Manager Handy was extended a hearty vote of appreciation for his work on the station.

On Friday evening the Board heard a supplementary oral report on the Cairo conference by Secretary Warner and General Counsel Segal, in which the loyal support of the United States government and the growing antipathy toward the institution of amateur radio abroad were emphasized. Following a period of questioning concerning details, the Board unanimously expressed its hearty appreciation to Messrs. Segal and Warner.

After considerable discussion, it was agreed to request the F.C.C. to withdraw the present television assignments at 1.7 and 56 Mc., and to suggest its authorization in the new bands above 112 Mc. to be opened effective October 1st. Facsimile, etc., will be continued as at present.

By an expression of policy the Board provided that it may authorize the taking of an advisory informative poll through the columns of *QST* as to the wishes of amateurs generally or the membership alone, as the case may be, concerning questions that may arise. Discussion having produced no clear unanimity on two questions arising following the adoption of this proposal, they were referred for such a poll. These questions were the proposal to request the F.C.C. to open the new 2000-2050 kc. territory to 'phone, and one requiring that same standards of stability, etc., as now exist

on 28 Mc. and below, be applied to the five-meter band as well.

Through a series of enabling motions, the Board first amended the By-Laws to allow the holding of a national convention (actually, a convention covering the operating territory of the League), and then decided to hold such a convention in Chicago in September of this year. Thereupon a formal, detailed request by the Chicago Area Radio Council to be authorized to manage and conduct this convention was considered and accepted. A contractual agreement was effected covering all details of administration, accounting, etc., under supervisory control of the League's Executive Committee.

By motion of Director Mathews, adopted without dissent, Communications Manager Handy was instructed to undertake a revision

of the present QSL-card handling system to relieve the district QSL managers in those districts where they are overburdened. It was decided to modify the four-year licensed-amateur and A.R.R.L.-membership requirements for directorial candidates by providing that they apply for any four out of five preceding years, rather than on a fully continuous basis.

As a result of a motion by Director Arledge, an appropriation was made for the purpose of defraying the expenses of S.C.M.'s to their divisional or state convention once yearly, a schedule of permissible expenses being stipulated. A qualification of this action makes mandatory the submission of a report of activity during the meeting attended.

By motion of Mr. Blalack the Secretary and Communications Manager were instructed to draft a detailed outline of procedure in the handling of A.R.R.L.-sponsored conventions, to be submitted to the Board for its consideration and recommendations.

All Executive Committee minutes are hereafter to be incorporated in the minutes of the Board and published in *QST*, as a result of a motion by Mr. McCargar.

By motion of Mr. Blalack, it was decided, after discussion, to hold the 1939 meeting of

the Board in a suitable place in San Francisco, Calif.

After a period of discussion, the Board approved the principle of adopting some plan of optional retirement benefits for A.R.R.L. employees, and appointed a committee consisting of Messrs. Martin, Bailey and Mathews to prepare a detailed report on this subject.

Routine actions included the usual appropriations for directors' expenses and the expenses of the meeting, a revision in the stipulated order of business, advancing the date for the

close of nominations in directors' elections, ordering publication of the tentative agenda in *QST* preceding each meeting, the affiliation of various clubs, etc.

Motions directing the editor of *QST* to publish not more than one letter authorized by each director in each issue,

to make a reasonable increase in the 3.9-4 Mc. 'phone band, withdrawing the voting power of the president and vice-president, ordering the taking of a verbatim stenographic record of the proceedings of the Board, directing the submission of all expenses to the Board in budget form, and establishing local units in League organization, were among those considered and defeated.

Without taking any action, the Board discussed, among other things, the effect on A.R.R.L. legislative activities of its income-tax exemption, the status of the A.A.R.S. with respect to the League, the B.C.L. interference problem, 'phone allocations, methods of increasing the membership, etc.

Total appropriations exceeded \$18,000—approximately the same figure as for the two preceding years, although the disposition of funds has been widely different in these years. The sum is, nevertheless, an indication of the activity of the Board in providing services and facilities for the membership good.

Owing to the postponement of the meeting this year, the bulk of *QST* is off the press as this is written, and it has been impossible to provide more than a hurried and sketchy review. The detailed minutes of the meeting will appear in the July issue.

Officers' Reports Available to Members

In April of each year the officers of the League make comprehensive written reports to the Board of Directors. The Board of Directors has made these reports available to the membership of the League. Interested members may obtain copies postpaid at the estimated cost price of 50 cents per copy. Address the Secretary at West Hartford.